

2020



**Hultafors**





**Hultafors**



# Hold 130 years of experience in your hand.

Ask any professional user of tools you like. They'll tell you – "If you want the real deal, it has to be Hultafors." By choosing a Hultafors tool, you are getting a tool that delivers the best possible functionality, precision and quality.

The knowledge Hultafors have of professional users' workday is undeniably unique. As is the extensive experience. Since it all started with the now world-renowned folding rule in 1883, we have spent 130 years developing and manufacturing tools for craftsmen.

We offer a wide selection of hand tools for all types of professional craftsmanship. Our products are developed in cooperation with professional users aiming to contribute to making the workday as smooth and efficient as possible.

Hultafors products are designed with your best interest in mind. We strive to develop long-lasting products in durable materials and with ergonomic design. This way we can maximize the life span of our products and at the same time minimize our environmental impact. Tools you can rely on in all situations, every day.



A handwritten signature in white ink, appearing to read 'Håkan Carlsson'.

Håkan Carlsson  
Commercial Manager



# Content

## Measuring

FOLDING RULES .....	6
TAPE MEASURES .....	14
MARKING MEASURES .....	26
SQUARES.....	30
OTHER MEASUREMENTS .....	36

## Marking

PENS .....	40
CHALK LINES .....	44

## Leveling

SPIRIT LEVELS .....	50
LASERS .....	62
DISTANCE MEASURERS.....	66
LASER ACCESSORIES .....	70

## Striking

HAMMERS .....	78
SLEDGES .....	92
SPARE HANDLES .....	97

## Chopping

AXES .....	98
SPARE HANDLES .....	108



## Cutting

SNAP-OFF KNIVES .....	110
CRAFTSMAN'S KNIVES .....	122
UTILITY KNIVES.....	132
DOUBLE HOLSTERS.....	138
CHISELS .....	144

Sawing .....	150
--------------	-----

Clamping .....	160
----------------	-----

## Wrecking and Prying

WRECKING BARS .....	164
PRY BARS .....	171

Carrying .....	174
----------------	-----

Advertising print .....	178
-------------------------	-----

## Learn more

BLADE TYPES.....	192
MARKING MEASURES .....	194
MITRE SQUARE .....	195
LIBELLA 2000 .....	196
NAIL PULLER ATLE .....	197
HOLSTERS.....	197
TAKE CARE OF YOUR AXE .....	198
ADJUSTABLE WRECKING BAR .....	200







# Developed with experience.

## THE CRAFTSMAN'S BEST FRIEND.

The red ends, the blond downy birch and the characteristic smoothness of the joints. Originating from 1883, our classic folding rule has long since reached legendary status. We are continuously developing new versions of the original and you can find folding rules in wood, fibreglass and aluminium. All with the ambition to be the craftsman's best friend for a long time. This product is FSC®-certified which means that it's made of certified and controlled material. By choosing the 2.40, you help to take care of the world's forests.

### FOLDING RULE 59-2.4-12

2.4 m long. Made from carefully selected, FSC®-certified Swedish birch wood.

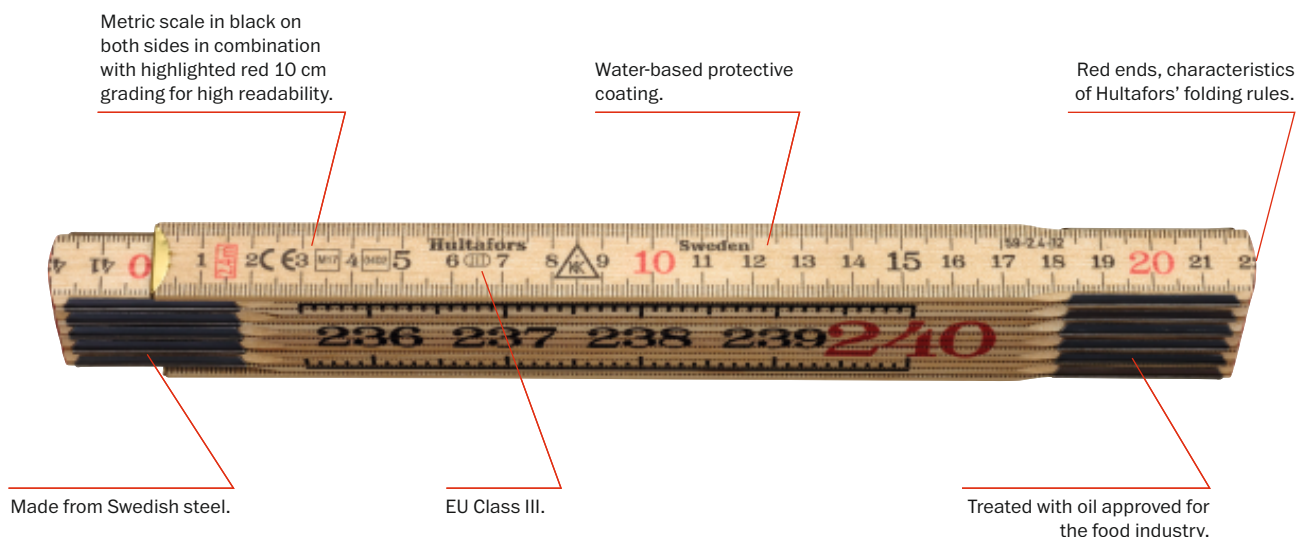

## Choose the right material.

FIBREGLASS, BIRCH OR ALUMINIUM.

Our classic folding rules are made from downy birch. However, we also produce rules in fibreglass-reinforced polyamide and anodized aluminium, allowing you to choose the material that is the best fit for your job. The aluminium folding rule is appreciated by users working close to heat, for example when welding. The fibreglass rule is unaffected by water and therefore a good choice for craftsmen doing masonry, or working with paint and plaster.

## Accurate measurement.

MANUFACTURED TO STRINGENT REQUIREMENTS.

All our folding rules are calibrated to the very highest levels of accuracy and are compliant with EU requirements for Class III. This means that a 2 metre long folding rule has a maximum deviation of  $\pm 1.4$  mm and a 1 m folding rule a deviation of  $\pm 1$  mm. The measurement over an articulated joint has a deviation of no more than  $\pm 0.5$  mm. But we don't stop there. Our manufactory process is governed by a quality system certified in accordance with ISO 9001.





EU CLASS III

mm

WOOD

2.4 m



## Folding Rule 59-2.4-12

Hultafors' original is now available in a longer version! Same high quality and features but in a 2.4m version, adapted to current building standards. Traditionally manufactured in our factory in Sweden. Made from hand picked birch wood and high quality hinges made from Swedish steel in combination with the red ends according to Hultafors characteristics. This new model has inherited the techniques from our ongoing development work (starting in 1883) in order to secure precision (EU Class III & CE marking), thin sections, high readability, maximised durability and the right feeling. Metric scale in black on both sides of the section in combination with highlighted red 10 cm grading for high readability. Each section is checked with a high speed camera twice in production to secure the accuracy.

- EU Class III.
- 2.4 m length
- Water based protective coating
- Hultafors high quality hinges
- FSC®-certified

Stockcode	Graduation	Parts	Width	Qty/pack	Length (m)
100304 WOODEN FOLDING RULE 59-2.4-12	mm	12 pcs	17 mm	10 pcs	2.4 m



EU CLASS III

mm

1 m

2 m

WOOD

## Folding Rule 59

A Hultafors classic – a must for every craftsman. Traditionally manufactured from downy birch with Swedish steel joints, affording thin sections and great flexibility. Metric scale in black on both sides, and red decimetre figures.

- Type approved as per EU Class III.
- Coated with a water-based protective lacquer for increased resistance to dirt and moisture.
- The joints are heat-treated, coated and oiled at three points to ensure first-class performance.
- Each folding rule section is checked twice during the production process using high-speed cameras.

Stockcode	Graduation	Parts	Width	Qty/pack	Length (m)
100004 WOODEN FOLDING RULE 59-2-10	mm	10 pcs	17 mm	10 pcs	2 m
100005 FOLDING RULE, MM 59-2-10	mm	10 pcs	17 mm	50 pcs	2 m
100104 WOODEN FOLDING RULE 59-2-12	mm	12 pcs	17 mm	10 pcs	2 m
100105 WOODEN FOLDING RULE 59-2-12	mm	12 pcs	17 mm	50 pcs	2 m
100204 WOODEN FOLDING RULE 59-1-6	mm	6 pcs	17 mm	10 pcs	1 m



EU CLASS III

2 m

WOOD

mm CONTACT



## Folding Rule 559, Contact-meter

A folding rule made from downy birch with Swedish steel joints, affording thin sections and great flexibility. Internal metric scale on both sides depicted in black (centimetres/millimetres) and red (decimetres). Used for measuring directly on surfaces.

- Type approved as per EU Class III.
- Coated with a water-based protective lacquer for increased resistance to dirt and moisture.
- The joints are heat-treated, coated and oiled at three points to ensure first-class performance.
- Each folding rule section is checked twice during the production process using high-speed cameras.

Stockcode	Graduation	Parts	Width	Qty/pack	Length (m)
101804 Folding rule 559 559-2-10	mm/contact	10 pcs	17 mm	10 pcs	2 m





- 1 m
- 2 m
- WOOD
- mm
- INCH

### Folding Rule 61

A classic folding rule manufactured from downy birch with Swedish steel joints, affording thin sections and great flexibility. Scale with black figures on both sides, metric along the bottom edge and British imperial along the top edge.

- Coated with a water-based protective lacquer for increased resistance to dirt and moisture.
- The joints are heat-treated, coated and oiled at three points to ensure first-class performance.
- Each folding rule section is checked twice during the production process using high-speed cameras.

Stockcode	Graduation	Parts	Width	Qty/pack	Length (m)
100504 WOODEN FOLDING RULE 61-2-10	mm/inch	10 pcs	17 mm	10 pcs	2 m
100505 WOODEN FOLDING RULE 61-2-10	mm/inch	10 pcs	17 mm	50 pcs	2 m
100704 WOODEN FOLDING RULE 61-1-6	mm/inch	6 pcs	17 mm	10 pcs	1 m



- EU CLASS III
- 2 m
- WOOD
- mm
- DK INCH

### Folding Rule 82

A folding rule manufactured from downy birch with Swedish steel joints, affording thin sections and great flexibility. Metric scale on one side and Danish inches on the other.

- Coated with a water-based protective lacquer for increased resistance to dirt and moisture.
- The joints are heat-treated, coated and oiled at three points to ensure first-class performance.
- Each folding rule section is checked twice during the production process using high-speed cameras.

Stockcode	Graduation	Parts	Width	Qty/pack	Length (m)
101504 WOODEN FOLDING RULE 82-2-12	mm/DKinch	12 pcs	17 mm	10 pcs	2 m



- EU CLASS III
- 2 m
- WOOD
- mm
- 1 %

### Shrinkage Folding Rule 590

A shrinkage folding rule manufactured from downy birch with Swedish steel joints, affording thin sections and great flexibility. Metric scale on one side and a shrinkage scale in red figures on the reverse. Uses include the setting of casting moulds.

- Coated with a water-based protective lacquer for increased resistance to dirt and moisture.
- The joints are heat-treated, coated and oiled at three points to ensure first-class performance.
- Each folding rule section is checked twice during the production process using high-speed cameras.

Stockcode	Graduation	Parts	Width	Qty/pack	Length (m)
103104 SHRINKAGE FOLDING RULE 590-2-10 1%	mm/1% Shrinkage	10 pcs	17 mm	10 pcs	2 m



## Folding Rule, Blockmeter B 3500

A Central European style blockmeter manufactured from beech wood with Swedish steel joints. The compact sides giving excellent surface for advertising printing. 3 mm thick sections giving extra stability. Metric scale in black on both sides and red decimeter figures.



- Type approved as per EU Class III.
- Coated with a water-based protective lacquer for increased resistance to dirt and moisture.
- The joints are heat-treated epoxy and oiled a three points to ensure first class performance.

Stockcode	Graduation	Parts	Width	Hultafors - Colour	Qty/pack	Length (m)
108010 WOODEN FOLDING RULE B3500N DU	mm	10 pcs	17 mm	Natural	10 pcs	2 m
108710 WOODEN FOLDING RULE B3507W DU	mm	10 pcs	17 mm	White	10 pcs	2 m
108610 WOODEN FOLDING RULE B3506G DU	mm	10 pcs	17 mm	Yellow	10 pcs	2 m

## Folding Rule, Blockmeter H4000

A Central European style blockmeter manufactured from beech wood with Swedish steel joints. The compact sides giving excellent surface for advertising printing. 3 mm thick sections giving extra stability. Metric scale in black on both sides and red decimeter figures.



- Type approved as per EU Class III.
- Coated with a water-based protective lacquer for increased resistance to dirt and moisture.
- The joints are heat-treated epoxy and oiled a three points to ensure first class performance.
- Each folding rule section is checked twice during the production process using high-speed cameras.

Stockcode	Graduation	Parts	Width	Hultafors - Colour	Qty/pack	Length (m)
109011 WOODEN FOLDING RULE H4010N DU	mm	10 pcs	17 mm	Natural	10 pcs	2 m
109711 WOODEN FOLDING RULE H4010W DU	mm	10 pcs	17 mm	White	10 pcs	2 m
109611 WOODEN FOLDING RULE H4006G DU	mm	10 pcs	17 mm	Yellow	10 pcs	2 m
109311 WOODEN FOLDING RULE H4003WG DU	mm	10 pcs	17 mm	White/Yellow	10 pcs	2 m

## Folding Rule P600

A Central European style folding rule manufactured from beech wood with Swedish steel joints. 3 mm thick sections giving extra stability. Metric scale in black on both sides.



- Type approved as per EU Class III.
- Coated with a water-based protective lacquer for increased resistance to dirt and moisture.
- The joints are heat-treated epoxy and oiled a three points to ensure first class performance.

Stockcode	Graduation	Parts	Width	Hultafors - Colour	Qty/pack	Length (m)
106610 WOODEN FOLDING RULE P606G DU	mm	10 pcs	17 mm	Yellow	10 pcs	2 m
106010 WOODEN FOLDING RULE P610N DU	mm	10 pcs	17 mm	Natural	10 pcs	2 m
106710 WOODEN FOLDING RULE P607W DU	mm	10 pcs	17 mm	White	10 pcs	2 m
106729 WOODEN FOLDING RULE P607W DU 3M	mm	15 pcs	17 mm	White	5 pcs	3 m



## Folding Rule T59

A Central European style folding rule manufactured from beech wood with Swedish steel joints. 3 mm thick sections giving extra stability. Metric scale in black on both sides and red decimeter figures.



- Type approved as per EU Class III.
- Coated with a water-based protective lacquer for increased resistance to dirt and moisture.
- The joints are heat-treated epoxy and oiled a three points to ensure first class performance.
- Each folding rule section is checked twice during the production process using high-speed cameras.

Stockcode	Graduation	Parts	Width	Hultafors - Colour	Qty/pack	Length (m)
105354 WOODEN FOLDING RULE T59-2-10G TR	mm	10 pcs	17 mm	Yellow	10 pcs	2 m
105254 WOODEN FOLDING RULE T59-2-10VG TR	mm	10 pcs	17 mm	White/Yellow	10 pcs	2 m



## Folding Rule G59

Folding rule made from fibreglass-reinforced polyamide, affording increased resistance to moisture. Metric scale in black on both sides, and red decimetre figures.



- Increased resistance to moisture.
- Foil-embossed scale provides increased protection against wear.
- Type approved as per EU Class III.

Stockcode	Graduation	Parts	Width	Hultafors - Colour	Qty/pack	Length (m)
200004 FIBREGLASS FOLDING RULE G 59-2-10 GU	mm	10 pcs	15 mm	Yellow	10 pcs	2 m
200064 FIBREGLASS FOLDING RULE G 59-2-10 VI	mm	10 pcs	15 mm	White	10 pcs	2 m
200104 FIBREGLASS FOLDING RULE G 59-2-12 GU	mm	12 pcs	15 mm	Yellow	10 pcs	2 m
200154 FIBREGLASS FOLDING RULE G59-2-12 GU SM	mm	12 pcs	15 mm	Yellow	10 pcs	2 m
200204 FIBREGLASS FOLDING RULE G 59-1-6 GU	mm	6 pcs	15 mm	Yellow	10 pcs	1 m
200304 FIBREGLASS FOLDING RULE G 59-1-10 GU	mm	10 pcs	13 mm	Yellow	10 pcs	1 m
200364 FIBREGLASS FOLDING RULE G 59-1-10 VI	mm	10 pcs	13 mm	White	10 pcs	1 m



## Folding Rule G61

Folding rule made from fibreglass-reinforced polyamide, affording increased resistance to moisture. Scale with black figures on both sides, metric along the bottom edge and British imperial along the top edge.



- Increased resistance to moisture.
- Foil-embossed scale provides increased protection against wear.

Stockcode	Graduation	Parts	Width	Hultafors - Colour	Qty/pack	Length (m)
200404 FIBREGLASS FOLDING RULE G 61-2-10 GU	mm/inch	10 pcs	15 mm	Yellow	10 pcs	2 m
200504 FIBREGLASS FOLDING RULE G 61-1-6 GU	mm/inch	6 pcs	15 mm	Yellow	10 pcs	1 m



## Folding Rule GE59

Folding rule made from fibreglass-reinforced polyamide, affording increased resistance to moisture. End-piece of stainless steel on the first and last stick which will increase protection against wearing. Metric scale in black on both sides, and red decimetre figures.

- Increased resistance to moisture.
- End-piece in stainless steel.
- Foil-embossed scale provides increased protection against wear.
- Type approved as per EU Class III.

Stockcode	Graduation	Parts	Width	Hultafors - Colour	Qty/pack	Length (m)
200604 FIBREGLASS FOLDING RULE GE 59-2-10 GU	mm	10 pcs	15 mm	Yellow	10 pcs	2 m
200664 FIBREGLASS FOLDING RULE GE 59-2-10 VI	mm	10 pcs	15 mm	White	10 pcs	2 m

## Folding rule G 59-1-4-12

A Dutch model of a 4-fold rule manufactured in ABS plastic.

- Hard-wearing ABS.
- Brass hinged pins and end-pieces for extended life.



Stockcode	Graduation	Parts	Width	Hultafors - Colour	Qty/pack	Length (m)
200904 FIBREGLASS FOLDING RULE G59-1-4-12 GU	mm	4 pcs	12 mm	Yellow	10 pcs	1 m
201004 FIBREGLASS FOLDING RULE G59-1-4-12 VI	mm	4 pcs	12 mm	White	10 pcs	1 m



## Folding Rule A59

A folding rule made from anodised aluminium with galvanised steel joints. Metric graduations in black on both sides. Good resistance to moisture, heat and wear.

- Anodised aluminium with galvanised steel joints affords increased protection against corrosion.
- Highly resistant to moisture, heat and wear.
- Type approved as per EU Class III.

Stockcode	Graduation	Parts	Width	Qty/pack	Length (m)
150003 ALUMINIUM FOLDING RULE A 59-2-10	mm	10 pcs	15 mm	5 pcs	2 m
150103 ALUMINIUM FOLDING RULE A 59-1-6	mm	6 pcs	15 mm	5 pcs	1 m





1 m

2 m

ALUMINIUM



mm  
INCH

## Folding Rule A61

A folding rule made from anodised aluminium with galvanised steel joints. Scale with black figures on both sides, metric along the bottom edge and British imperial along the top edge. Good resistance to moisture, heat and wear.

- Anodised aluminium with galvanised steel joints affords increased protection against corrosion.
- Good resistance to moisture, heat and wear.

Stockcode	Graduation	Parts	Width	Qty/pack	Length (m)
150203 ALUMINIUM FOLDING RULE A 61-2-10	mm/inch	10 pcs	15 mm	5 pcs	2 m
150303 ALUMINIUM FOLDING RULE A 61-1-6	mm/inch	6 pcs	15 mm	5 pcs	1 m





# Tape measures with precision.

MAKE SURE YOU GET IT RIGHT THE FIRST TIME.

The most important consideration when choosing a tape measure is precision. High precision tools reduce the risk of errors. Hultafors steel tape measures offer the highest precision on the market – EU Class 1. The majority of our measuring tapes are graduated using inkjet technology to achieve the high level of precision. Our range includes both short and long tape measures in several materials, reaching from 3 metres to 100 metres.

## SHORT STEEL TAPE BT

Double printed blade with CC-scale on the back.



## EU class I and II.

TAPE MEASUREMENT ACCURACY.

Measurement accuracy is a very important feature of a tape measure. It is measured and stated in the form of a tolerance class. In Europe, we normally classify measuring tapes in EU Class I and EU Class II. The accuracy is measured at 20 °C and 50 N pull force for steel tape and 20 °C and 20 N pull force for fibreglass tape.

## Seasonal adaptation.

TEMPERATURE AFFECTS THE LENGTH.

Major temperature changes can have a significant effect on the length of a steel tape measure. The tolerance for our tape measures apply at 20 °C. We often experience significant temperature differences between summer and winter. That is why it is important to be aware of the measurement deviations for various temperatures.

LEARN MORE ABOUT  
BLADE TYPES AT PAGE 192



### Short Tape Steel PR

Tough tape with ergonomic grip, rubber coated button and brake pad area, with a high impact case made of ABS plastic. Yellow, wear resistant blade graduated using highly accurate inkjet print. Smooth blade return action and bump stop with anti-wear function.

- Type approved as per EU Class I.
- Metal hole hanger for strap enabling safe work at heights.
- Strong stainless steel end-hook with reinforcement plate.
- Distinct brake causing no blade movement.
- The blade can be replaced and is available as a spare.

Stockcode	Graduation	Qty/pack	Spare blade	Blade width tapes	Length
350103 MEASURING TAPE mm PR 3M	mm	2 pcs	350111 .	19 mm	3m
350203 MEASURING TAPE mm PR 5M	mm	2 pcs	350211 .	19 mm	5m
350223 MEASURING TAPE mm/inch PR 5ME	mm/inch	2 pcs	350231 .	19 mm	5m/16ft
350303 MEASURING TAPE mm PR 8M	mm	2 pcs	350311 .	25 mm	8m
350323 MEASURING TAPE mm/inch PR 8ME	mm/inch	2 pcs	350331 .	25 mm	8m/26ft



### Short Tape Steel SL

Slim model with a high impact case made of ABS plastic. Yellow, wear resistant blade graduated using inkjet print. Smooth blade return action and bump stop with anti-wear function.

- Type approved as per EU Class I.
- Metal hole hanger for strap enabling safe work at heights.
- Strong stainless steel end piece with reinforcement plate.
- Distinct brake causing no blade movement.
- The blade can be replaced and is available as a spare.

Stockcode	Graduation	Qty/pack	Spare blade	Blade width tapes	Length
351103 MEASURING TAPE mm SL 3M	mm	2 pcs	351111 .	16 mm	3m
351203 MEASURING TAPE mm SL 5M	mm	2 pcs	351211 .	19 mm	5m



### Short Tape Steel BT

Steel tape with marks on both sides for precise measures and setting out walls. Yellow steel blade graduated using highly accurate inkjet print with a matt finish allowing reflection-free reading. The back of the blade is marked with CC-measurement for 30/60 and 45 cm to assist with setting out walls. Rubber protection at all impact points and a high impact case made of ABS plastic. Integrated bump stop for blade return protection.

- Unique belt clip with a quick release function that allows the tape to be released with one hand.
- Ergonomic thumb brake for easy blade locking.
- CC-graduation for every 30/60 and 45 cm.
- Internal measurements can be taken by simply adding 100 mm.
- Rubber end-hook with clearance for internal and external measurement.

Stockcode	Graduation	Qty/pack	Spare blade	Blade width tapes	Length
356103 MEASURING TAPE BT 5M	mm	5 pcs	356111 .	19 mm	5m
356123 MEASURING TAPE SHORT BT 5M	mm	2 pcs	356111 .	19 mm	5m
356203 MEASURING TAPE BT 8M	mm	5 pcs	356211 .	25 mm	8m
356223 MEASURING TAPE SHORT BT 8M	mm	2 pcs	356211 .	25 mm	8m



## Short Tape Steel PFX



Yellow, impact resistant steel tape measure, graduated using highly accurate inkjet print. An excellent value tape measure for both professional and DIY use.

- Tough, ABS case.
- Positive action brake.
- Self-zeroing end-hook.
- Belt clip.

Stockcode	Graduation	Qty/pack	Blade width tapes	Length
366003 Measuring Tape Short PFX 3M	mm	2 pcs	13 mm	3m
366103 Measuring Tape Short PFX 5M	mm	2 pcs	19 mm	5m

## Short Tape Steel TK



Yellow, impact resistant steel tape measure. A tough, multi-protected tape measure, ideal for both professional and DIY use.

- Tough, ergonomic case with rubber-like outer casing.
- Positive action brake.
- Automatic blade return with snake-spring brake.
- Self-zeroing end-hook.
- Detachable belt clip.

Stockcode	Graduation	Qty/pack	Blade width tapes	Length
367003 Measuring Tape Short TK 3M	mm	2 pcs	13 mm	3m
367103 Measuring Tape Short TK 5M	mm	2 pcs	19 mm	5m
367203 Measuring Tape Short TK 8M	mm	2 pcs	25 mm	8m

## Short Tape Steel TMC



Yellow, impact resistant steel tape measure, graduated using highly accurate inkjet print. A range of high specification automatic return tapes designed for the professional user. Exceptionally accurate, durable and reliable.

- Tough ABS case with chrome finish.
- Positive action non-slip two part blade lock.
- Automatic blade return with bump stop for added blade and end-hook protection.
- Belt clip and self-zeroing end-hook.

Stockcode	Graduation	Qty/pack	Blade width tapes	Length
368003 Measuring Tape Short TMC 3M	mm	2 pcs	13 mm	3m
368103 Measuring Tape Short TMC 5M	mm	2 pcs	19 mm	5m
368203 Measuring Tape Short TMC 8M	mm	2 pcs	25 mm	8m
368303 Measuring Tape Short TMC 10M	mm	2 pcs	25 mm	10m



**Hultafors**  
CELESTIO  
15m  
CLASS 2  
Fiberglass  
COUNTER  
Product No. 87-1524 EU



## Short Tape Steel UM



Yellow, impact resistant steel tape measure, graduated using highly accurate inkjet print. A compact tape with smooth rounded case, which fits comfortably into the palm of the hand during use. Ideal for both professional and DIY use.

- ABS case, ultrasonically welded for added strength.
- Positive action side lock brake.
- Automatic blade return.
- Self-zeroing end-hook.
- Belt clip.

Stockcode	Graduation	Qty/pack	Blade width tapes	Length
369003 Measuring Tape Short UM 3M	mm	2 pcs	16 mm	3m
369103 Measuring Tape Short UM 5M	mm	2 pcs	16 mm	5m

## Short Tape Steel AP



Tough, high impact ABS case with rubber overmould and positive action brake. Yellow, wear resistant blade with smooth blade return action.

- Type approved as per EU Class II.
- Strong metal end-hook with reinforcement plate.
- Positive action brake locks the blade solidly at the required length.

Stockcode	Graduation	Qty/pack	Length (m)	Blade width tapes
370103 MEASURING TAPE SHORT AP3M	mm	6 pcs	3 m	16 mm
370203 MEASURING TAPE SHORT AP5M	mm	6 pcs	5 m	19 mm
370303 MEASURING TAPE SHORT AP8M	mm	6 pcs	8 m	25 mm



## Bench Tape Steel TRB

This tape measure is designed to be fitted to cutting benches. It is produced in corrosion protected steel, graduated in millimetres and has a blade width of 13 mm. Available with scale running right to left or left to right.

- The scale is protected by a nylon coating, making the tape particularly wear-resistant.
- The tape is protected against corrosion and can withstand contact with the majority of chemicals and solvents.
- Type approved as per EU Class II.



Stockcode	Graduation	Qty/pack	Scale	Blade width tapes	Length
357003 MEASURING TAPE, steel TRB 3 HV	mm	5 pcs	right-left	13 mm	3m
357103 MEASURING TAPE, steel TRB 3 VH	mm	5 pcs	left-right	13 mm	3m
357403 MEASURING TAPE, steel TRB 10 HV	mm	5 pcs	right-left	13 mm	10m
357503 MEASURING TAPE, steel TRB 10 VH	mm	5 pcs	left-right	13 mm	10m



### Long Tape Steel CC

Tape with a unique one hand grip for each case size enabling optimal handling. White, impact resistant steel tape, graduated using highly accurate ink jet print. Protected by an additional transparent polyester top coating and a high impact case made of ABS plastic - made to take a beat. Unique loop with added features and a type B tape start. Mouth-piece with anti-wear function. Hole hanger for strap enabling safe work at heights.

- Type approved as per EU Class I.
- The steel tape can withstand gentle bending, but should not be folded.
- Scale is protected by a matt polyester lacquer that also reduces glare.
- The tape is protected against corrosion and can withstand contact with moisture and the majority of solvents.
- Tape measure CC in medium size case has quick gear function 3:1.

Stockcode	Graduation	Case	Qty/pack	Spare blade	Blade width tapes	Length
390103 MEASURING TAPE STEEL CC 10M	mm	Small	2 pcs	390109 .	10 mm	10m
390203 MEASURING TAPE STEEL CC 20M	mm	Small	2 pcs	390209 .	10 mm	20m
390303 MEASURING TAPE STEEL CC 30M	mm	Medium	2 pcs	390309 .	10 mm	30m
390403 MEASURING TAPE STEEL CX 30M	mm	Large	2 pcs	390509 .	13 mm	30m
390503 MEASURING TAPE STEEL CC 50M	mm	Large	2 pcs	390409 .	13 mm	50m



### Long Tape Fibreglass CC F

Tape with a unique one hand grip for each case size enabling optimal handling. Yellow fibreglass, 13mm blade width, with a high impact case made of ABS plastic - made to take a beat. Unique loop with added features and a type B tape start. Mouth-piece with anti-wear function. Hole hanger for strap enabling safe work at heights.

- Type approved as per EU Class II.
- Fibreglass tape is strong, flexible and can be bent without any problem.
- The tape can withstand moisture, temperature fluctuations, the majority of chemicals and is electrically non-conductive.

Stockcode	Graduation	Case	Qty/pack	Spare blade	Blade width tapes	Length
391103 MEASURING TAPE FIBREGLASS CC 10FM	mm	Large	2 pcs	391109 .	13 mm	10m/33ft
391203 MEASURING TAPE FIBREGLASS CC 20FM	mm	Large	2 pcs	391209 .	13 mm	20m/66ft
391303 MEASURING TAPE FIBREGLASS CC 30FM	mm	X-Large	2 pcs	391309 .	13 mm	30m
391423 MEASURING TAPE FIBREGLASS CC 15FMD	mm	Large	2 pcs	391429 .	13 mm	15m



### Long Tape Steel SY

Yellow, impact resistant steel tape measure, 13 mm blade width. The tape also has a thick nylon coating for additional durability, type approved as per EU class 1. Impact resistant ABS frame with rubber over mould protection. Easy clean blade feed with side flush apertures. Scaled diameter blade drum for balanced rewind speed. Press button firm blade lock with simple lock release.

- Right and left hand flip-out ergonomic rewind handle and low friction action for smooth rewind.
- Integral ground spike for end-hook anchoring.
- Corrosion resistant triple action end-hook.
- Rubber grip top handle and lower base grip.
- Press button firm blade lock with simple lock release.

Stockcode	Graduation	Qty/pack	Blade width tapes	Length
353401 MEASURING TAPE, LONG SY 30M B	mm	1 pcs	13 mm	30m
353501 MEASURING TAPE, LONG SY 50M B	mm	1 pcs	13 mm	50m



### Long Tape Fibreglass PC

Yellow fibreglass tape measure, 13 mm blade width, highly flexible tape with extra thick coating, offering superior resistance to scuffing and marking, ABS plastic frame. Available with either type A or C tape starts.

- Fibreglass tape is strong, flexible and can be bent without any problem.
- The tape can withstand moisture, temperature fluctuations, the majority of chemicals and is electrically non-conductive.
- Type approved as per EU Class II.
- ABS plastic makes the frame both light and durable.

Stockcode	Graduation	Qty/pack	Spare blade	Blade width tapes	Length
352601 MEASURING TAPE PC 30M A	mm	1 pcs	352611 .	13 mm	30m
352651 MEASURING TAPE PC 30M C	mm	1 pcs		13 mm	30m
352671 MEASURING TAPE FIBREGLASS PC 30M B	mm	1 pcs		13 mm	30m
352701 MEASURING TAPE PC 50M A	mm	1 pcs	352711 .	13 mm	50m
352751 MEASURING TAPE PC 50M C	mm	1 pcs		13 mm	50m
352771 MEASURING TAPE FIBREGLASS PC 50M B	mm	1 pcs		13 mm	50m



### Long Tape Steel PL

Yellow, impact resistant steel tape measure, 10 mm blade width, graduated using highly accurate inkjet print, with an extra thick nylon coating for added protection\*, with an ABS plastic frame. Available with either type A or C tape starts. \*352581 and 352591 have a 13mm wide white polyester coated blade.

- This steel tape can be bent and twisted without any problem, but must not be folded.
- The scale is protected by a nylon coating, making the tape particularly wear-resistant.
- The tape is protected against corrosion and can withstand contact with the majority of chemicals and solvents.
- Type approved as per EU Class II.
- ABS plastic makes the frame both light and durable.

Stockcode	Graduation	Qty/pack	Scale	Spare blade	Blade width tapes	Length
352401 MEASURING TAPE PL 30M A	mm	1 pcs	mm	352411 .	10 mm	30m
352451 MEASURING TAPE PL 30M C	mm	1 pcs	mm		10 mm	30m
352501 MEASURING TAPE PL 50M A	mm	1 pcs	mm	352511 .	10 mm	50m
352551 MEASURING TAPE PL 50M C	mm	1 pcs	mm		10 mm	50m
352581 MEASURING TAPE PL 100M A	mm	1 pcs	mm		13 mm	100m
352591 MEASURING TAPE PL 100M C	mm	1 pcs	mm		13 mm	100m

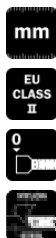

### Long Tape Steel YL

Yellow, impact resistant steel tape measure, 13 mm blade width, graduated using highly accurate inkjet print, with an extra thick nylon coating for added protection. Type C tape start.

- This steel tape can be bent and twisted without any problem, but must not be folded.
- The scale is protected by a nylon coating, making the tape particularly wear-resistant.
- The tape is protected against corrosion and can withstand contact with the majority of chemicals and solvents.
- Type approved as per EU Class II.

Stockcode	Graduation	Qty/pack	Scale	Blade width tapes	Length
355451 MEASURING TAPE YL 30M C	mm	1 pcs	mm	13 mm	30m
355551 MEASURING TAPE YL 50M C	mm	1 pcs	mm	13 mm	50m





### Long Tape Steel TR

Stainless, deep-etched steel tape measure, 13 mm blade width, graduated in millimetres with an aluminium frame. Type A tape start.

- The tape is made from stainless steel, which makes it resistant to moisture and wear brought about by daily use.
- Highly resistant to corrosion and abrasion.
- Type approved as per EU Class II.

Stockcode	Graduation	Qty/pack	Scale	Spare blade	Blade width tapes	Length
355581 MEASURING TAPE TR 10M A	mm	1 pcs	cm	355591 .	13 mm	10m
355601 MEASURING TAPE TR 20M A	mm	1 pcs	cm	355611 .	13 mm	20m
355801 MEASURING TAPE TR 30M A	mm	1 pcs	cm	355811 .	13 mm	30m
355901 MEASURING TAPE TR 50M A	mm	1 pcs	cm		13 mm	50m



### Long Tape Steel TRT

Stainless, deep-etched steel tape measure, 13 mm blade width, graduated in millimetres with an aluminium frame. The tape has a pointed brass weight on its end and is designed to measure depths in things such as tanks and wells.

- The tape is made from stainless steel, which makes it resistant to moisture and wear brought about by daily use.
- Highly resistant to corrosion and abrasion.
- Type approved as per EU Class II.
- The brass weight is 70 mm long and weighs 280 g.

Stockcode	Graduation	Qty/pack	Scale	Blade width tapes	Length
355651 MEASURING TAPE TRT 20M	mm	1 pcs	cm	13 mm	20m
355851 MEASURING TAPE TRT 30 M	mm	1 pcs	cm	13 mm	30m



### Long Tape Steel PT

White, impact resistant steel tape measure, 10 mm blade width, graduated using highly accurate ink jet print. Printing is protected by an additional transparent polyester top coating, with an ABS plastic case. Type B tape start.

- The steel tape can withstand gentle bending, but should not be folded. Can be replaced if damaged.
- Scale is protected by a matt polyester lacquer that also reduces glare.
- The tape is protected against corrosion and can withstand contact with moisture and the majority of solvents.
- Type approved as per EU Class II.
- ABS plastic makes the case both light and durable.

Stockcode	Graduation	Qty/pack	Scale	Spare blade	Blade width tapes	Length
352803 MEASURING TAPE PT 10M B	mm	5 pcs	mm	352821 .	10 mm	10m
352903 MEASURING TAPE PT 20M B	mm	5 pcs	mm	352921 .	10 mm	20m
353003 MEASURING TAPE PT 30M B	mm	5 pcs	mm	353021 .	10 mm	30m



### Long Tape Fibreglass FI

Yellow fibreglass tape measure, 13 mm blade width, highly flexible tape with extra thick coating to offering superior resistance to scuffing and marking, ABS plastic case. Type C tape start.

- Fibreglass tape is strong, flexible and can be bent without any problem.
- The tape can withstand moisture, temperature fluctuations, the majority of chemicals and is electrically non-conductive.
- Type approved as per EU Class II.
- ABS plastic makes the case both light and durable.

Stockcode	Graduation	Qty/pack	Blade width tapes	Length
354503 MEASURING TAPE FI 10M C	mm	5 pcs	13 mm	10m
354603 MEASURING TAPE FI 20M C	mm	5 pcs	13 mm	20m
354703 MEASURING TAPE FI 30M C	mm	5 pcs	13 mm	30m



### Long Tape Steel TRR

Ruggedly constructed open frame tape ideal for on-site measuring. Tape construction enables cleaning and maintenance. Corrosion resistant frame with ABS hand grip. Type B tape start.

- 13 mm Whitecote polyester coated steel tape.
- Type approved as per EU Class II.
- High impact polymer centre.
- Long winding lever and easy-grip knob.

Stockcode	Graduation	Qty/pack	Blade width tapes	Length
356601 Tracker, whitecote TRR 20M B	mm	1 pcs	13 mm	20m
356801 Tracker, whitecote TRR 30M B	mm	1 pcs	13 mm	30m
356901 Measuring Tape Long TRR 50M B	mm	1 pcs	13 mm	50m



### Spare blade Short Tape Steel PR

Spare blade for Short Tape Steel PR. By replacing a worn out blade to a new blade, you prolong the life span of the PR. It is a Sustainable Choice that is better for the environment.

Stockcode	Graduation	Qty/pack	Fits to	Blade width tapes	Length
350111 REFILL BLADE PR RB PR 3M	mm	1 pcs	350103	19 mm	3m
350211 REFILL BLADE PR RB PR 5M	mm	1 pcs	350203	19 mm	5m
350311 REFILL BLADE PR RB PR 8M	mm	1 pcs	350303	25 mm	8m



### Spare blade Short Tape Steel SL

Spare blade for Short Tape Steel SL. By replacing a worn out blade to a new blade, you prolong the life span of the SL. It is a Sustainable Choice that is better for the environment.

Stockcode	Graduation	Qty/pack	Fits to	Blade width tapes	Length
351111 REFILL BLADE SL RB SL 3M	mm	1 pcs	351103	16 mm	3m
351211 REFILL BLADE SL RB SL 5M	mm	1 pcs	351203	19 mm	5m



### Spare blade Short Tape Steel BT

Spare blade for Short Tape Steel BT. By replacing a worn out blade to a new blade, you prolong the life span of the BT. It is a Sustainable Choice that is better for the environment.

Stockcode	Graduation	Fits to	Blade width tapes	Length
356111 MEASURING TAPE RB BT 5M	mm	356103, 356123	19 mm	5m
356211 MEASURING TAPE RB BT 8M	mm	356203, 356223	25 mm	8m



### Spare blade Long Tape Fibreglass PC

Spare blade for Long Tape Fibreglass PC. By replacing a worn out blade to a new blade, you prolong the life span of the PC. It is a Sustainable Choice that is better for the environment.

Stockcode	Graduation	Fits to	Blade width tapes	Length
352611 SPARE BLADE RB PC 30m, A	mm	352601	13 mm	30m
352711 SPARE BLADE RB PC 50m, A	mm	352701	13 mm	50m





### Spare blade Long Tape Steel CC

Spare blade for Long Tape Steel CC. By replacing a worn out blade to a new blade, you prolong the life span of the CC. It is a Sustainable Choice that is better for the environment.



Stockcode	Graduation	Qty/pack	Fits to	Blade width tapes	Length
390109 REFILL BLADE CC RB CC 10M	mm	1 pcs	390103	10 mm	10m
390209 REFILL BLADE CC RB CC 20M	mm	1 pcs	390203	10 mm	20m
390309 REFILL BLADE CC RB CC 30M	mm	1 pcs	390303	10 mm	30m
390509 REFILL BLADE CC RB CX 30M	mm	1 pcs	390503	13 mm	30m



### Spare blade Long Tape Fibreglass CC F

Spare blade for Long Tape Fibreglass CC F. By replacing a worn out blade to a new blade, you prolong the life span of the CC F. It is a Sustainable Choice that is better for the environment.



Stockcode	Graduation	Qty/pack	Fits to	Blade width tapes	Length
391109 REFILL BLADE CC F RB CC 10FM	mm	1 pcs	391103	13 mm	10m
391209 REFILL BLADE CC F RB CC 20FM	mm	1 pcs	391203	13 mm	20m
391309 REFILL BLADE CC F RB CC 30FM	mm	1 pcs	391303	13 mm	30m
391429 REFILL BLADE CC F RB CC 15FMD	mm	1 pcs	391423	13 mm	15m



### Spare blade Long Tape Steel TR

Spare blade for Long Tape Steel TR. By replacing a worn out blade to a new blade, you prolong the life span of the TR. It is a Sustainable Choice that is better for the environment.



Stockcode	Graduation	Fits to	Blade width tapes	Length
355591 SPARE TAPE TRACKER RB TR 10m, A	mm	355581	13 mm	10m
355611 SPARE TAPE TRACKER RB TR 20m, A	mm	355601	13 mm	20m
355811 SPARE TAPE TRACKER RB TR 30m, A	mm	355801	13 mm	30m



PATENT APP. FILED EP 08152206.2

**Hultafors**  
TALMETER  
3M

# Taking measuring further.

## MEASURING & MARKING MADE EASY.

The unique marking measures from Hultafors have facilitated work for craftsmen for decades. What makes the TALMETER marking measure so special is the fact that you can take a measurement and then mark it directly onto your workpiece. Without even reading off the scale to verify the length.

### MARKING MEASURE TALMETER

The TALMETER is used when measuring and marking lengths and for etching arcs.

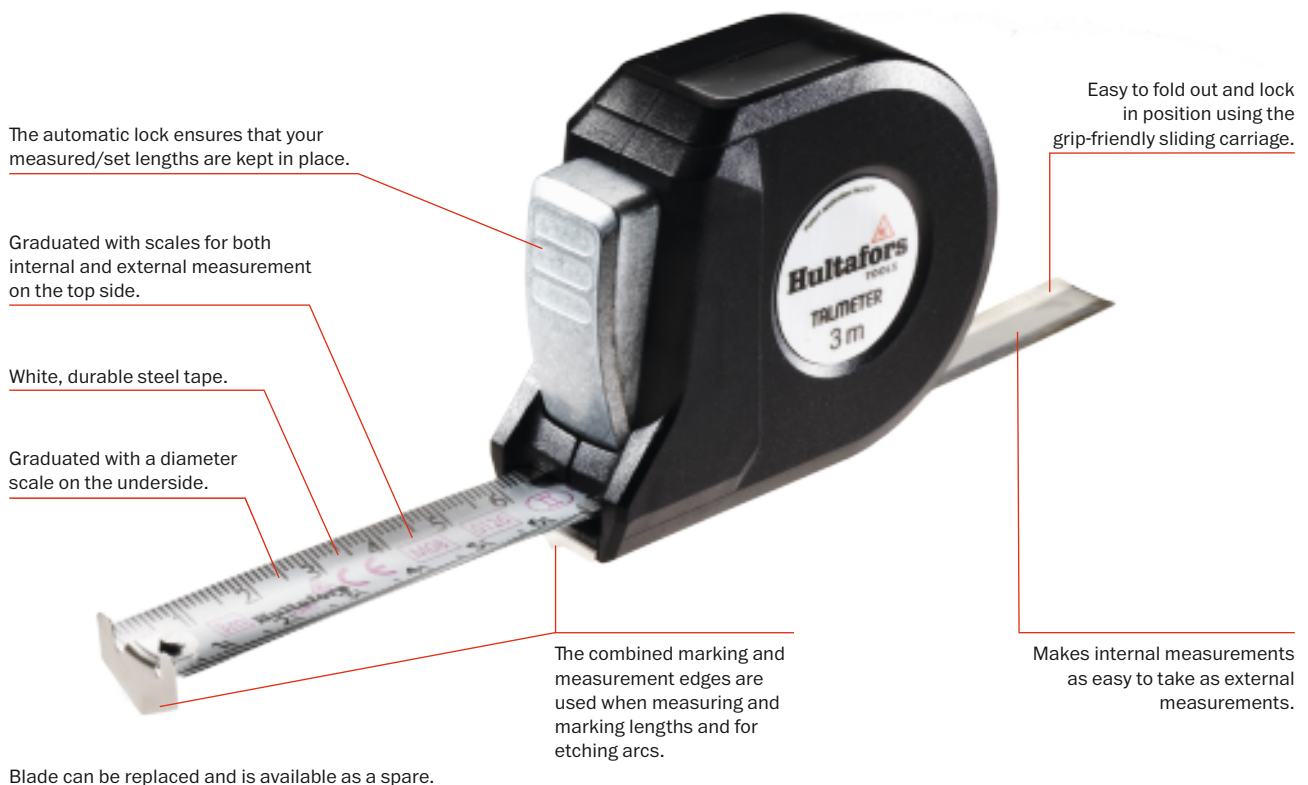

### Simple measuring.

FOR BOTH INTERNAL AND EXTERNAL MEASUREMENTS.

Thanks to the combined measuring and marking edges and a firm brake you can keep your set measurement and securely transfer it to any object. Over and over again. Furthermore, it is equally simple to take both internal and external measurements, trace arcs and – depending on model – even diameters and circumferences. So go ahead and explore the possibilities. Take your measuring further with a TALMETER marking measure from Hultafors.

### The perfect combination.

MARKING AND MEASURING WITH ACCURACY.

With a TALMETER, you don't have to convert the measurement you have taken to measurement units. Instead, it's simply a matter of aligning the marking and measurement edges between the measurement points of the object being measured. The scale is automatically locked at this length and, using the same measurement and marking edges, you then etch the exact length on the workpiece. This can be done one or more times without any changes in accuracy.

LEARN MORE ABOUT  
MARKING MEASURE AT PAGE 194





- 2 m
- EU CLASS II
- TALMETER
- 3 m

### Marking Measure Talmeter 2M/3M

White, impact resistant steel tape measure, 16 mm blade width, graduated in millimetres with an ABS plastic case. Combined marking and measurement edges mean that you can quickly and simply measure and mark both internal and external lengths. The tape and extender can be replaced and are available as spare parts.

- Internal and external measurement using etching function.
- Diameter measurement with scale on the reverse side of the tape.
- The TALMETER has a calliper function that is handy to mark out round shapes.
- The scale is always locked in normal position.
- The extender is easy to extend and retract using the grip-friendly sliding carriage.

Stockcode	Graduation	Qty/pack	Tape width	Length (m)	Spare blade	Blade width tapes
359103 TALMETER TALMETER 2M	mm	6 pcs	16	2 m	359111 .	16 mm
359203 TALMETER TALMETER 3M	mm	6 pcs	16	3 m	359211 .	16 mm
359003 TALMETER, SPARE PART MT-SL	mm	6 pcs				



- EU CLASS II
- TALMETER
- 6 m

### Marking Measure Talmeter 6M

White, impact resistant steel tape measure, 25 mm blade width, graduated in millimetres using inkjet technology with an ABS plastic case. Combined marking and measurement edges mean that you can quickly and simply measure and mark both internal and external lengths. The tape and extender can be replaced and are available as spare parts.

- Internal and external measurement using etching function.
- Unique belt clip with a quick release function that allows the marking measure to be released with one hand.
- Vertical scale on the reverse side of the tape.
- The TALMETER has a caliper function that is handy to mark out round shapes.
- The extender is easy to extend and retract using the grip-friendly sliding carriage.

Stockcode	Graduation	Qty/pack	Spare blade	Blade width tapes	Length
359303 MARKING MEASURE TALMETER 6M	mm	2 pcs	359311 .	25 mm	6m



- EU CLASS II
- TALMETER
- 3 m

### Marking Measure TALMETER 3M VP

A marking measure for craftsmen working on hot surfaces or with ventilation pipes, requesting the mm and diameter scale to be on the same front side of the blade. White, impact resistant steel tape measure, 16 mm blade width, graduated in millimetres, with an ABS plastic case. Combined marking and measurement edges mean that you can quickly and simply measure and mark both internal and external lengths. The tape and extender can be replaced and are available as spare parts.

- Internal and external measurement using etching function.
- Diameter measurement with scale on the front side of the blade above the millimetre scale.
- The Talmeter has a calliper function which is useful when marking round shapes.
- The scale is always locked in normal position.
- The extender is easy to open out and retract using the grip-friendly sliding carriage.

Stockcode	Graduation	Qty/pack	Spare blade	Blade width tapes	Length
359403 TALMETER TALMETER 3M VP	mm	6 pcs	359411 .	16 mm	3m
359411 TALMETER SCALE RB TALM 3M VP	mm	6 pcs		16 mm	3m



2 m

EU CLASS II



3 m

### Spare blade Talmeter 2M/3M

Spare blade for Talmeter 2M/3M. By replacing a worn out blade to a new blade, you prolong the life span of the Talmeter. It is a Sustainable Choice that is better for the environment.

Stockcode	Fits to	Blade width tapes	Length
359111 TALMETER, SCALE RB TALMETER 2M	359103	16 mm	2m
359211 TALMETER, SCALE RB TALMETER 3M	359203	16 mm	3m



EU CLASS II



6 m



### Spare blade Talmeter 6M

Spare blade for Talmeter 6M. By replacing a worn out blade to a new blade, you prolong the life span of the Talmeter. It is a Sustainable Choice that is better for the environment.

Stockcode	Graduation	Qty/pack	Fits to	Blade width tapes	Length
359311 SPARE BLADE RB talmeter 6M	mm	1 pcs	359303	25 mm	6m



**Hultafors**

METRIC

HIP-VAL

TOP CUTS

COMMON

80 DEG.

PIVOT





# Robust and versatile tool.

HIGH PRECISION AND MULTIFUNCTIONAL.

Hultafors introduces the rafter square, an interesting tool with many different functions. It especially comes into its own when building stairs and rafters. Then it is perfect to have on hand to quickly and easily mark out angles. Despite this, many craftsmen have never used the tool. We want to change that.

## METRIC RAFTER SQUARE

The rafter square is used to mark 45 and 90 degree markings quickly and accurately.



## A versatile tool.

USE FOR MARKING AND SAW GUIDE.

Thanks to the strong edge, the rafter square can be used as a guide when sawing, for both cross sections and angled sections. The tool is also provided with scales for cutting rafters while the grooves in the triangle act as support when marking out, for example, longitudinal lines or when cutting plasterboard to size.

## The perfect combination.

MARKING AND MEASURING WITH ACCURACY.

The rafter square is a robust and versatile tool. It is made of solid aluminium and has CNC-machined edges for optimum precision and high wear resistance. The gradations are laser etched and resist wear and provide optimal readability. The square has an anodised, protective and low reflective surface. It also has scales on the inside that act as support when marking our longitudinal lines or when cutting plasterboard to size.



## Rafter Square

The Rafter Square is a robust and versatile tool for all craftsmen. It features a solid aluminum body with CNC-machined edges for greater accuracy and durability. The tool allows you to make fast and precise 45° and 90° markings. In addition, its thick edge is useful as a saw guide – it can be used directly with the saw against the square for cross cuts or angled cuts. This highly versatile tool can be used indirectly as well, using the scribing notches to create a pencil line or for when cutting plaster with a knife. The Hultafors Rafter Square can also be used as a protractor, for easily finding and marking various common angles. The tool has scales for cutting hip, valley and jack rafters.

- Solid aluminum body with CNC-machined edges for greater accuracy and durability.
- Low-glare protective anodized finish.
- Graduations are laser etched, highly resistant to wear and numbers are highly visible.
- Scribing notches.
- Thick edge is useful as a saw guide.

Stockcode	Graduation	Fixed/Adjustable	Qty/pack	Blade length
257010 Metric Rafter Square MRS	mm	Fixed	2 pcs	18 cm



## Plaster Square PS

Adjustable plaster square with millimeter and degree graduations that can be set in four fixed positions. The stock and blade can be folded together, making it easy to store and transport and also be switch between right and left position.

- The foldable function makes storage and transport easier.
- 4 angles with fixed positions (22,5° , 45° , 67,5° ,90°).
- Additional 21 angles marked on the scale.
- Stock and blade in anodized aluminium.

Stockcode	Graduation	Fixed/Adjustable	Qty/pack	Blade length	Weight
253510 PLASTER SQUARE ADJUSTABLE PS 90	mm	Adjustable	2 pcs	90 cm	995 g
253501 PLASTER SQUARE ADJUSTABLE PS 120	mm	Adjustable	2 pcs	120 cm	1150 g



## Adjustable Square QUATTRO

Square with millimetre graduations that can be set to three positions: 45°, 90° and 135°. The stock and blade can also be folded together, making it easy to store and keep in the pocket of your work trousers.

- The stock is made from anodised aluminium.
- The blade is 45 mm wide and made from stainless steel.
- Graduations are deep etched and highly resistant to wear.

Stockcode	Graduation	Fixed/Adjustable	Stock material	Qty/pack	Blade length
253103 ADJUSTABLE SQUARE QUATTRO 25	mm	Adjustable	Aluminum	5 pcs	25 cm



- STAINLESS STEEL
- 25 cm
- 20 cm
- 30
- 45 mm
- ±0.03'

## Square Professional

Square with aluminum stock and millimetre graduations on the upper and lower edges of the blade.

- The blade is made from stainless steel, measuring 1.5x45 mm.
- The stock is made from anodised aluminum, with an 18 mm wide milled working surface.
- Graduations are deep etched and highly resistant to wear.

Stockcode	Graduation	Fixed/Adjustable	Stock material	Qty/pack	Blade length
260003 SQUARE, STAINLESS V 20 P	mm	Fixed	Aluminum	5 pcs	20 cm
260103 SQUARE, STAINLESS V 25 P	mm	Fixed	Aluminum	5 pcs	25 cm
260203 SQUARE, STAINLESS V 30 P	mm	Fixed	Aluminum	5 pcs	30 cm



- STAINLESS STEEL
- 25 cm
- ±0.06'
- 20 cm
- 30
- 45 mm

## Square Semi-Professional

Square with fibreglass-reinforced ABS plastic stock and millimetre graduations on the upper and lower edges of the blade.

- The blade is made from stainless steel, measuring 1.0x45 mm.
- Fibreglass-framed ABS plastic stock, with an 18 mm wide working surface.
- Graduations are deep etched and highly resistant to wear.

Stockcode	Graduation	Fixed/Adjustable	Stock material	Qty/pack	Blade length
310003 SQUARE, STAINLESS V 20 S	mm	Fixed	Plastic	5 pcs	20 cm
310103 SQUARE, STAINLESS V 25 S	mm	Fixed	Plastic	5 pcs	25 cm
310203 SQUARE, STAINLESS V 30 S	mm	Fixed	Plastic	5 pcs	30 cm



- 1.0
- 1.0

## Carpenter's Square TMV

Carpenter's square with epoxy-lacquered steel stock and millimetre graduations on the upper and lower edges of the blade.

- Yellow epoxy-lacquered steel square.
- Tolerance ±1.0 mm/m.
- Screen printed mm graduations.

Stockcode	Graduation	Fixed/Adjustable	Stock material	Qty/pack	Blade length
251003 CARPENTERS SQUARE TMV 60	mm	Fixed	Steel	5 pcs	60 cm
251103 CARPENTER'S SQUARE TMV 80	mm	Fixed	Steel	5 pcs	80 cm
251203 CARPENTERS SQUARE TMV 100	mm	Fixed	Steel	5 pcs	100 cm





Hultafors





20 cm



### Bevel Square SMV

Bevel square with stainless steel blade and aluminium stock with milled working surfaces, for copying and transferring angles to workpieces.

- Stainless steel blade.
- Aluminium stock with milled working surfaces.
- Screw for locking the blade is located in the end of the stock for improved accessibility.

Stockcode	Fixed/Adjustable	Stock material	Qty/pack	Blade length
256003 BEVEL SQUARE SMV 20	Adjustable	Aluminum	5 pcs	20 cm

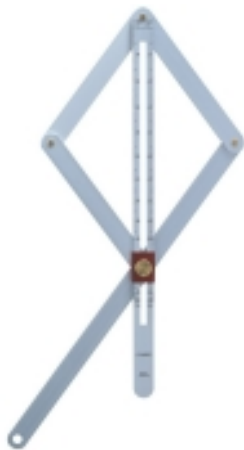

### Combi Square

The combi square is used to measure existing angles or to transfer angles from a point of measurement to a workpiece.

- Made from anodised aluminum for increased corrosion resistance.
- Alpha x read on the left side of the scale, Beta x on the right.
- Can be used to read angles between 20° and 160°.

Stockcode	Fixed/Adjustable	Stock material	Qty/pack	Blade length
252003 COMBINATION SQUARE COMBI	Adjustable	Aluminum	5 pcs	17 cm



### Mitre Square GV

Automatically produces the correct angle when cutting mitres without having to perform any calculations. When the tool is steplessly turned to the desired angle, the indicator flag divides the angle by two.

- The guide is made from fibreglass-reinforced nylon, with an indicator flag of electrogalvanised metal.
- Automatically produces the correct angle when cutting mitres.
- Can be used for both internal and external angles.

Stockcode	Fixed/Adjustable	Stock material	Qty/pack
254003 ANGLEFIX GV	Adjustable	Plastic	4 pcs

## Levelling Rod 701

Levelling rod made of wood, length 2 m and 1 section, width 35 mm.

- Yellow reflector with cm scale on one side.
- Natural with mm scale on the other side.
- Solid wood core and brass fittings.



Stockcode	Graduation	Parts	Width	Qty/pack	Length (m)
450341 LEVELLING ROD 701 RG1 N2	cm, mm, N 2	1 pcs	35 mm	1 pcs	2 m

## Levelling Rod 702

Levelling rod made of wood, length 2.5 m and 2 sections, width 35 mm.

- Yellow reflector with cm scale on one side.
- Natural with mm scale on the other side.
- Solid wood core and brass fittings.



Stockcode	Graduation	Parts	Width	Qty/pack	Length (m)
450371 LEVELLING ROD 702 RG1 N2	cm, mm	2 pcs	35 mm	1 pcs	2.5 m

## Levelling Rod 704

Levelling rod made of wood, length 4 m and 4 sections, width 35 mm.

- Yellow reflector with cm scale on one side.
- Model N2 natural with mm scale on the other side.
- Model RG6 has a yellow reflector with feet scale in tenths on the other side.
- Solid wood core and brass fittings.



Stockcode	Graduation	Parts	Width	Qty/pack	Length (m)
450101 LEVELLING ROD 704 RG1 N2	cm, mm, N 2	4 pcs	35 mm	1 pcs	4 m
450111 LEVELLING ROD 704 RG1 N2L	cm, N 2	4 pcs	35 mm	1 pcs	4 m
450201 LEVELLING ROD 704 RG1 RG6	cm, RG 6, Inch	4 pcs	35 mm	1 pcs	4 m



## Extension Rod 710

Levelling rod extension made of wood.

- Yellow reflector with cm scale on one side.
- Solid wood core and brass fittings.



Stockcode	Graduation	Parts	Width	Qty/pack	Length (m)
450401 LEVELLING ROD, EXT SECT 710 RG1	cm	2 pcs	36 mm	1 pcs	2 m

## Levelling Rod Mini

Foldable levelling rod made of wood. Designed as a folding rule which makes it easy to fold and carry.

- Yellow reflector with cm scale on one side.
- Natural with mm scale on the other side.
- Brass end fittings.



Stockcode	Graduation	Parts	Width	Qty/pack	Length (m)
450704 MINI LEVELLING ROD 742 RG1 N2	cm, mm	6 pcs	23 mm	10 pcs	2 m
450904 MINI LEVELLING ROD 743 RG1 N2	cm, mm	6 pcs	23 mm	10 pcs	3 m

## Bench Rule

With metric graduation.



Stockcode	Graduation	Length	Qty/pack	Width/Thickness
550004 METRE STICK, mm SLM 50	cm, mm	500 mm	10 pcs	25/5 mm
550104 METRE STICK, mm SLM 100	mm	1000 mm	10 pcs	25/5 mm

## Counter Rule

With metric graduation.



Stockcode	Graduation	Length	Qty/pack
550201 COUNTER RULE, mm BUM 50	500 mm	650 mm	1 pcs
550301 COUNTER RULE, mm BUM 100	1000 mm	1145 mm	1 pcs

## Glasscutter's Rule

With metric graduation.



Stockcode	Graduation	Length	Qty/pack
550411 GLASS CUTTING RULE - H GLM 100	1000 mm	1060 mm	1 pcs
550501 GLASSCUTTING RULE, HANDLE GLM HANDLE			1 pcs

## Plank Rule

Shrinkage scale on reverse.



Stockcode	Graduation	Parts	Length	Qty/pack	Width/Thickness
551204 BOARD RULE PLM 33	cm, mm	2 pcs	330 mm	10 pcs	17/6 mm

## Wood Rule

With metric graduation.



Stockcode	Graduation	Parts	Length	Qty/pack	Width/Thickness
551601 TIMBER RULE WITH HOOK VEM 300	cm, mm	3 pcs	3000 mm	1 pcs	35/15 mm

## Personal Rule

With metric graduation.



Stockcode	Length	Qty/pack	Width/Thickness
552801 HIGHT MEASURER PEM 136	1360 mm	1 pcs	40/20 mm
552901 STRETCHER PEM SLIDER		1 pcs	-



## Steel Ruler

Steel scale in tempered stainless steel, with matt chromeplated surface for anti-glare reading. Graduated in millimetres along the upper edge and half-millimetres along the lower edge. The reverse side is blank.

- Made from tempered stainless steel for extra durability.
- The surface is matt chrome-plated for anti-glare and more accurate reading.
- Graduated in millimetres along the upper edge, half-millimetres along the lower edge and with decimetre figures in red.
- Tolerance  $\pm 0.3$  mm/m.



Stockcode	Graduation	Length	Qty/pack	Width/Thickness
554003 STEEL RULER STL 150	mm	150 mm	5 pcs	14,7/0,6 mm
554103 STEEL RULER STL 300	mm	300 mm	5 pcs	23,7/1,0 mm
554203 STEEL RULER STL 600	mm	600 mm	5 pcs	28,5/1,2 mm
554303 STEEL RULER STL 1000	mm	1000 mm	5 pcs	35,0/1,5 mm







# Make your mark.

## THE NEXT GENERATION OF MARKERS.

Hultafors range of marking tools consists of both traditional carpenter pencils and the next generation of tools for marking.

The products are developed together with professionals and are designed for making your workday more efficient, no matter what material you are dealing with.

### DRY MARKER

Grip-friendly pencil in holster with built-in sharpener for clear markings.



Shaped to ensure that the pencil stays in place even when you move.

Easy to remove from its holster.

Roll stop on both pencil and holster.

Easy to change lead.

Grip-friendly and ergonomic design.

Optimized lead for durability and resistance to moisture.

Accessible sharpener.

Refill is available with 10 leads in a smart container.

Dirt and moisture is led away from the pencil for an increased durability.

### A new classic.

SHARP PENCIL, PRECISE MARKS.

With our Dry-Marker we have put extra attention to details. It combines the shape of the traditional carpenter's pencil with the classic school pencil, so you can both draw rough lines and make precision marks. The design of the holster with a built-in sharpener makes the pencil easy to sharpen. That way you always have a sharp tip close to hand.

### Need a refill?

GRAPHITE OR CHALK.

The design with refill lead extend the usage of the Dry-Marker and makes it last longer. Dry-Marker Refill comes with 10 leads for marking on all types of surfaces. The design of the container protects the leads during transport and only ejects one lead at a time. The refill is available in two combinations; 10 leads in durable graphite or 4 graphite leads and 6 pieces in chalk, 3 red and 3 yellow.

## Dry marker



Grip-friendly pen in holster with built-in sharpener for clear markings. Hultafors Dry-Marker is easy to remove from its holster, so you do not have to let go of what you are working with. The shape of the holster ensures that the pen stays in place even when you move. The pen's sharpener is in the holster for easy access. Via a hole in the bottom of the holster, dirt and moisture are led away from the pen for a longer durability. Easy to change lead.

- Grip-friendly and ergonomic design.
- Roll stop on both pen and holster.
- Sharp and accessible sharpener placed in the holster
- Optimized lead for durability and resistance to moisture
- Refill is available with 10 leads in a smart container

Stockcode	Qty/pack
650100 HULTAFORS DRY MARKER HDM	10 pcs

## Dry marker Refills



Smart container with 10 leads for marking on all types of surfaces. Hultafors Refill can be attached with a clip in the pocket or tool bag. The design of the container protects the leads during transport and only ejects one lead at a time. The refill is available in two combinations; 10 leads in durable graphite or 4 graphite leads and 6 leads in chalk, 3 red and 3 yellow. Refill fits the Hultafors Dry-Marker.

- Refill with 10 leads for Dry-Marker
- The container protects the leads during transport
- Ejects one lead at a time
- Clips for easy storage in pocket or bag
- Two variants; graphite or graphite and chalk

Stockcode	Hultafors - Colour	Qty/pack
650110 REFILL DISPENSER GRAPHITE HRD G	Graphite	10 pcs
650120 REFILL DISPENSER GRY HRD GRY	GRY	10 pcs

## Ink deep-hole marker



Ink pencil for marking in hard-to-reach places and in narrow holes. Hultafors Ink Deep-Hole Marker is adapted for marking in hard-to-reach places and in narrow holes. Available in permanent red and black ink for use on most materials and surfaces.

- Available in permanent red and black ink
- For marking in hard-to-reach places
- Works on most materials and surfaces

Stockcode	Hultafors - Colour	Qty/pack
650310 INK DEEPHOLE MARKER BLACK HIDHM B	Black	10 pcs
650320 INK DEEP-HOLE MARKER RED HIDHM R	Red	10 pcs





## Dry markers & refills, display pack

A compact and easy-to-install display that combines Dry-Marker and Refill to Dry-Marker. Holds 20 pieces of Dry-Marker and 10 Refill, 5 of each combination; graphite or graphite and chalk..

Stockcode	Qty/pack
650130 DRY MARKERS&REFILLS DISP HDM RD	1 pcs



## Carpenter's Pencil SNP

Carpenter's pencil made from linden wood with a medium-hard lead (HB), for optimal function on wood, plaster and other soft materials.

- Easy to sharpen as linden is a softwood with few transversal fibres.
- Medium-hard lead (HB) for optimal function on wood, plaster and other soft materials.
- Supplied in display box containing 200 pencils.



Stockcode	Length	Qty/pack	Hardness
650207 CARPENTER'S PENCIL SNP 18 RED	180 mm	200 pcs	HB
650707 CARPENTERS PENCIL SNP 18 BLACK	180 mm	200 pcs	HB
650407 CARPENTER'S PENCIL SNP 24 BLUE	240 mm	200 pcs	HB
650807 CARPENTER'S PENCIL SNP 24 BLUEOVAL	240 mm	200 pcs	HB



## Concrete Pencil BEP

Concrete pencil made from linden wood with a very hard lead. Ideal if you need to mark hard surfaces such as stone and concrete.

- Easy to sharpen as linden is a softwood with few transversal fibres.
- Very hard lead (10 H) for optimal function on hard surfaces such as stone and concrete.
- Supplied in a practical display box.



Stockcode	Length	Qty/pack	Hardness
650307 CARPENTER'S PENCIL BEP 30 GREEN	300 mm	200 pcs	10 H



CLP 30  
**Hultafors**  
30m  
7132527107 / 9 842827 00000 7 / 10173278 6 / 10173271 7



- 175 mm
- 2H
- H
- 
- x 12

## Workshop Pencils VEP

Available in two different hardnesses, medium (H) and hard (2H).

- Supplied in a cardboard box of 12.

Stockcode	Length	Qty/pack	Hardness
650507 PENCIL VEP 175 H	175 mm	144 pcs	H
650607 PENCIL VEP 175 2H	175 mm	144 pcs	2H



- 150 mm
- 

## Pencil Extension

Made from ABS plastic, allowing you to use the full length of the pencil.

- Fits both carpenter's and concrete pencils.
- Supplied in packs of 2.

Stockcode	Length	Qty/Pack (pcs)
650254 PENCIL EXTENDER PEFO 150	150 mm	10 x 2



- 30m
- SPARE PARTS
- UP TO 10
- 100g
- 3X
- OVERLOAD PROTECTION

## Chalkline CLP

Chalk line with 30 m line, metal crank and quick gear function 3:1. The house is manufactured in ABS plastic with a big opening for refilling and a cap with bayonet joint. Contains 100g of chalk. The line is braided cotton/polyester - with high absorbing chalk capacity - considerable increased numbers of distinct lines, up to 10 lines. Crank with ergonomic release button and knob. Crank can be locked in open and closed position. The cap is secured by the hook, no line hanging loose. Secure strap function.

- Overload protection reducing the risk for damaging the gear mechanism and the line to break.
- Release function in open and closed crank position. (Crank will not spin when pulling out line).
- Braided line with high absorbing chalk capacity - considerable increased numbers of distinct lines.
- Gear function 3:1, rewinds the line 3 times faster.
- The cap is divisible, makes it simple to replace the line.

Stockcode	Chalk volume	Geared	Qty/pack	Weight	Length (m)	Line diameter
652113 CHALKLINE CLP 30	100 g	Yes	2 pcs	205 g	30 m	1,2 mm
652133 SPARELINE RCL 30			1 pcs	65 g	30 m	1,2 mm



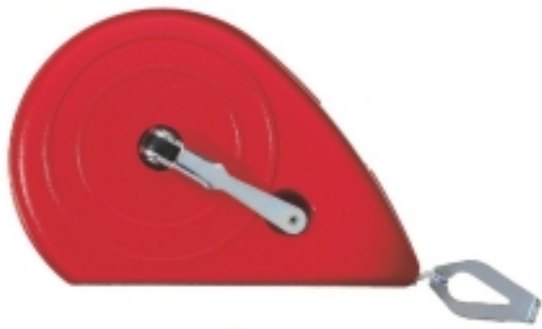

**30m**

**80 g**

**SPARE PARTS**

### Chalk line AL

Chalk line in cast powder coated aluminium housing with sliding filler cover. The line is braided cotton/polyester.

- The cotton absorbs the chalk, the polyester provides the strength.
- The braiding ensures that the line does not tangle.
- The line is 1 mm in diameter and has a rupture limit of 16 kg. Also available as a spare part.
- Holds 80 g of chalk.

Stockcode	Chalk volume	Geared	Qty/pack	Weight	Length (m)	Line diameter
652153 CHALKLINE AL 30	80 g	No	6 pcs	140 g	30 m	1 mm
652143 SPARELINE RAL 30			6 pcs	60 g	30 m	1 mm



**SPARE PARTS**

**50m**

### Chalk line RL

Large chalk line with extra strong cord that is ideal for demanding outdoor work. The housing is made from hard and durable polystyrene plastic. Chalk is filled via a bottle attached directly to the chalkline. The bottle is not included.

- The cotton absorbs the chalk, the polyester provides the strength.
- The braiding ensures that the line does not tangle.
- The line is 3 mm in diameter and has a rupture limit of 55 kg. The line is available as a spare part.
- Holds 700 g of chalk, including a standard bottle.

Stockcode	Chalk volume	Geared	Qty/pack	Weight	Length (m)	Line diameter
652181 CHALKLINE RL 50	700 g	No	1 pcs	620 g	50 m	3 mm
652191 SPARELINE RRL 50			1 pcs	250 g	50 m	3 mm



**30m**

**80 g**

**SPARE PARTS**

### Chalkline HHSK

Chalk line set including 100 g blue chalk. Chalk line with 30 m line, manufactured of polystyrene with removable filler cap. The line is of twisted cotton/polyester, 1 mm in diameter.

- Holds 80 g of chalk.
- Comes with 100 g blue chalk.

Stockcode	Chalk volume	Geared	Qty/pack	Weight	Length (m)	Line diameter
660103 CHALKLINE/CHALK HOBBY HHSK 30	80 g	No	12 pcs	80 g	30 m	1 mm



100  
g

360  
g

### Chalkline Chalk BLUE

This blue chalk is the most widely used chalk. It can be used for both indoor and outdoor work.

- Pigment-rich, producing clear and long-lasting lines.
- The chalk is finely milled and effectively attaches to the cord.
- Contains dolomite and ultramarine.

Stockcode	Qty/pack	Weight
652523 MARKING CHALK BLUE 100	6 pcs	100 g
652533 MARKING CHALK BLUE 360	6 pcs	360 g



400  
g

1000  
g



### Chalkline Chalk ULTRABLUE

This ultrablue chalk is optimised for outdoor use. It provides a strong, clear line that is extremely resistant to the effects of wind and rain.

- Pigment-rich, producing clear and long-lasting lines.
- The chalk is finely milled and effectively attaches to the cord.
- Contains dolomite and ultramarine.

Stockcode	Qty/pack	Weight
652633 MARKING CHALK ULTRA BLUE 400	6 pcs	400 g
652641 MARKING CHALK ULTRA BLUE 1000	1 pcs	1000 g



360  
g



### Chalkline Chalk WHITE

This white chalk is the only chalk that can be covered over with paint. Used mostly for indoor work.

- Pigment-rich, producing clear and long-lasting lines.
- The chalk is finely milled and effectively attaches to the cord.
- Contains dolomite.

Stockcode	Qty/pack	Weight
652233 MARKING CHALK WHITE 360	6 pcs	360 g



360 g

### Chalkline Chalk YELLOW

This yellow chalk is particularly suited to use on dark surfaces. It can be used for both indoor and outdoor work.

- Pigment-rich, producing clear and long-lasting lines.
- The chalk is finely milled and effectively attaches to the cord.
- Contains dolomite and iron oxide.

Stockcode	Qty/pack	Weight
652333 MARKING CHALK YELLOW 360	6 pcs	360 g



100 g

360 g

### Chalkline Chalk RED

This red chalk is an all-round chalk suitable for both indoor and outdoor work.

- Pigment-rich, producing clear and long-lasting lines.
- The chalk is finely milled and effectively attaches to the cord.
- Contains dolomite and iron oxide.

Stockcode	Qty/pack	Weight
652423 MARKING CHALK RED 100	6 pcs	100 g
652433 MARKING CHALK RED 360	6 pcs	360 g



200 g

NEON

### Chalkline Chalk H.V GREEN

This neon green chalk produces very clear lines. Can be used for both indoor and outdoor work.

- Produces strong, clear lines.
- The chalk is finely milled and effectively attaches to the cord.
- Pigment-rich, producing clear and long-lasting lines.

Stockcode	Qty/pack	Weight
652733 MARKING CHALK HIGH VIZ GREEN 200	6 pcs	200 g





## Chalkline Chalk H.V ORANGE

This neon orange chalk produces very clear lines. Can be used for both indoor and outdoor work.

- Produces strong, clear lines.
- The chalk is finely milled and effectively attaches to the cord.
- Pigment-rich, producing clear and long-lasting lines.

Stockcode	Qty/pack	Weight
652833 MARKING CHALK HIGH VIZ ORANGE 200	6 pcs	200 g



# Reach a new level.

## NEW AND IMPROVED.

MST is now available in two lengths. The MST 75 comes with two vials and the MST 180 has three. For professional craftsmen, a good spirit level is essential for a job well done. Our spirit levels are equipped with hard plastic vials that have a high degree of transparency and durability. The vial fluid is a low viscosity oil mixture that is resistant to temperature fluctuations, ultraviolet light and static electricity. To guarantee precision, all of our spirit levels are manufactured in accordance with a quality system that meets ISO 9001.

### SPIRIT LEVEL ALUMINIUM MST

- Our strongest and most sensitive spirit level.
- Tolerance in normal position  $\pm 0.3$  mm/m.
- Made from strong aluminium profile.
- Weight 1180 g/m.
- Aluminium profile 100x25 mm.
- Easy to clean.

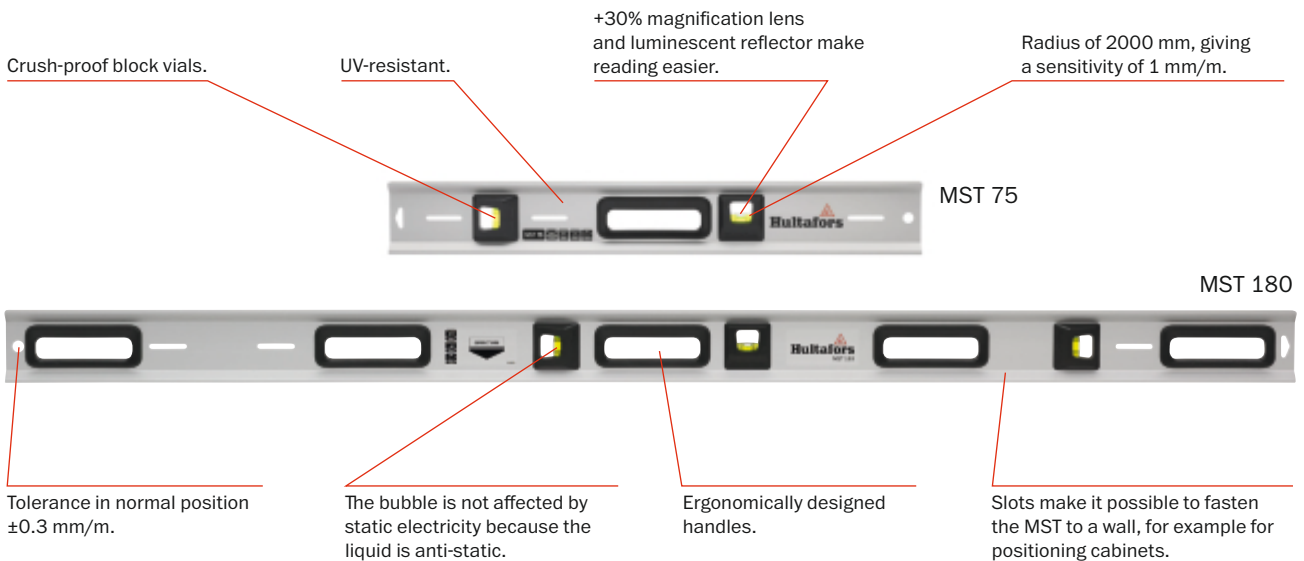

### High sensitivity.

DEPENDING ON THE TASK.

Some tasks require greater sensitivity. Therefore we make spirit levels with varying degrees of sensitivity. We offer spirit levels that are 5 to 10 times more sensitive than the standard. The more sensitive the vial is, the more accurate your work will be. If the vial is too sensitive for the task, the spirit level can be difficult to work with. The MST is our most sensitive spirit level. To protect the calibration of the vials, the plastic covers over the vials are not removable. It is therefore not possible to re-calibrate the product.





## Spirit Level Aluminium MST

The MST level is our strongest and most sensitive spirit level. Crush-proof block vials that is UV-resistant and withstands temperature changes with a +30% magnification lens and luminescent reflector for easier reading. Made from strong aluminium profile measuring 100x25 mm weighing 1180 g/m that is easy to clean and equipped with ergonomic handles.

- The radius of the vial is 2000 mm, giving a sensitivity of 1 mm/m.
- Tolerance in normal position is  $\pm 0.3$  mm/m.
- Slots in the Aluminium profile makes it possible to fasten the level against the wall for easier mounting of example cabinets.
- The liquid in the vial is highly resistant to ultraviolet light and temperature fluctuations and gives the bubble optimal freedom of movement.
- The anti-static properties of the liquid means that the bubble is not affected by static electricity.



Stockcode	Length	Qty/pack	Vials
402801 SPIRIT-LEVEL MST 75	750 mm	1 pcs	2 pcs
402901 SPIRIT-LEVEL MST 180	1800 mm	1 pcs	3 pcs



## Spirit Level Aluminium PV

Extra strong aluminium profile measuring 59x26 mm and weighing 880 g/m. Transparent and durable Crush-proof block vials with temperature-proof vial mountings, highly resistant to ultraviolet light and temperature fluctuations. Horizontal vial with a +30% magnification lens and luminescent reflector.

- Tolerance in normal position is  $\pm 0.5$  mm/m, upside down  $\pm 0.5$  mm/m.
- Focus vial with colour markings for easy reading and with a 200 mm radius giving a sensitivity of 10 mm/m.
- Shock absorbing end protectors with anti-slip function.
- The liquid in the vial is a low viscosity coloured oil mixture that gives the bubble optimal freedom of movement.
- The anti-static properties of the liquid means that the bubble is not affected by static electricity.

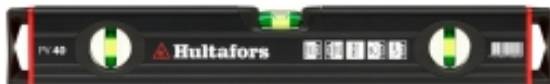

Stockcode	Length	Qty/pack	Vials
414001 SPIRIT-LEVEL PV 40	400 mm	1 pcs	3 pcs
414101 SPIRIT-LEVEL PV 60	600 mm	1 pcs	3 pcs
414201 SPIRIT-LEVEL PV 80	800 mm	1 pcs	3 pcs
414301 SPIRIT-LEVEL PV 100	1000 mm	1 pcs	3 pcs
414401 SPIRIT-LEVEL PV 120	1200 mm	1 pcs	3 pcs
414501 SPIRIT-LEVEL PV 140	1400 mm	1 pcs	3 pcs
414701 SPIRIT-LEVEL PV 200	2000 mm	1 pcs	3 pcs



## Spirit Level Aluminium HV

Strong, easy to hold aluminium profile measuring 51.5x25.3 mm and weighing 630 g/m. Crush-proof block vials that are highly transparent and durable. Horizontal vial with a +30% magnification lens and luminescent reflector. Shock absorbing end protectors and temperature-proof vial mountings.

- The radius of the vial is 200 mm, giving a sensitivity of 10 mm/m.
- Tolerance in normal position is  $\pm 0.5$  mm/m, upside down  $\pm 0.75$  mm/m.
- The liquid in the vial is a low viscosity coloured oil mixture that gives the bubble optimal freedom of movement.
- Highly resistant to ultraviolet light and temperature fluctuations.
- The anti-static properties of the liquid means that the bubble is not affected by static electricity.

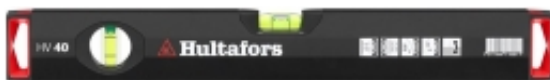

Stockcode	Length	Qty/pack	Vials
411001 SPIRIT-LEVEL HV 40	400 mm	1 pcs	2 pcs
411101 SPIRIT-LEVEL HV 60	600 mm	1 pcs	3 pcs
411201 SPIRIT-LEVEL HV 80	800 mm	1 pcs	3 pcs
411301 SPIRIT-LEVEL HV 100	1000 mm	1 pcs	3 pcs
411401 SPIRIT-LEVEL HV 120	1200 mm	1 pcs	3 pcs
411501 SPIRIT-LEVEL HV 150	1500 mm	1 pcs	3 pcs
411601 SPIRIT-LEVEL HV 180	1800 mm	1 pcs	3 pcs
411701 SPIRIT-LEVEL HV 200	2000 mm	1 pcs	3 pcs





### Spirit Level Aluminium HVP Magnet

Strong aluminium profile measuring 49x23 mm and weighing 650g/m, with magnets on the underside. Crush-proof block vials that are highly transparent and durable. Horizontal vial with a magnification lens and luminescent reflector.

- The radius of the vial is 200 mm, giving a sensitivity of 10 mm/m.
- Tolerance in normal position is  $\pm 0.5$  mm/m, upside down  $\pm 0.75$  mm/m.
- The liquid in the vial is a low viscosity coloured oil mixture that gives the bubble optimal freedom of movement.
- Highly resistant to ultraviolet light and temperature fluctuations.
- The anti-static properties of the liquid means that the bubble is not affected by static electricity.

Stockcode	Length	Qty/pack	Vials	Magnets
400753 SPIRIT-LEVEL HVP MAGNET 30	300 mm	1 pcs	2 pcs	1 pcs
400803 SPIRIT-LEVEL HVP MAGNET 40	400 mm	1 pcs	2 pcs	2 pcs
400903 SPIRIT-LEVEL HVP MAGNET 60	600 mm	1 pcs	2 pcs	2 pcs
401001 SPIRIT-LEVEL HVP MAGNET 120	1200 mm	1 pcs	2 pcs	4 pcs



### Spirit Level Aluminium I 360

Strong I-profile made from aluminium measuring 50x23 mm and weighing 640 g/m. Crush-proof tubular vials that are highly transparent and durable. The fully adjustable end vial can be turned 90 degrees for setting or checking slopes.

- The radius of the vial is 200 mm, giving a sensitivity of 10 mm/m.
- Tolerance in normal position is  $\pm 1.0$  mm/m.
- The liquid in the vial is a low viscosity coloured oil mixture that gives the bubble optimal freedom of movement.
- Highly resistant to ultraviolet light and temperature fluctuations.
- The anti-static properties of the liquid means that the bubble is not affected by static electricity.

Stockcode	Length	Qty/pack	Vials
401203 SPIRIT-LEVEL I360	600 mm	1 pcs	3 pcs



### Spirit Level Aluminium SM

Aluminium profile measuring 49x21 mm and weighing 520 g/m. Crush-proof block vials that are highly transparent and durable.

- The radius of the vial is 200 mm, giving a sensitivity of 10 mm/m.
- Tolerance in normal position is  $\pm 0.75$  mm/m, upside down  $\pm 1.0$  mm/m.
- The liquid in the vial is a low viscosity coloured oil mixture that gives the bubble optimal freedom of movement.
- Highly resistant to ultraviolet light and temperature fluctuations.
- The anti-static properties of the liquid means that the bubble is not affected by static electricity.

Stockcode	Length	Qty/pack	Vials
405831 SPIRIT-LEVEL SM 30	300 mm	1 pcs	2 pcs
405841 SPIRIT-LEVEL SM 40	400 mm	1 pcs	2 pcs
405851 SPIRIT-LEVEL SM 60	600 mm	1 pcs	2 pcs
405861 SPIRIT-LEVEL SM 80	800 mm	1 pcs	2 pcs
405881 SPIRIT-LEVEL SM 90	900 mm	1 pcs	2 pcs
405871 SPIRIT-LEVEL SM 100	1000 mm	1 pcs	2 pcs
405921 SPIRIT-LEVEL SM 120	1200 mm	1 pcs	3 pcs
405931 SPIRIT-LEVEL SM 150	1500 mm	1 pcs	3 pcs
405941 SPIRIT-LEVEL SM 180	1800 mm	1 pcs	3 pcs
405951 SPIRIT-LEVEL SM 200	2000 mm	1 pcs	3 pcs



### Mini Pocket Level

Hultafors MPL is a compact spirit level with a vial that has a magnifying effect for fast and reliable horizontal measuring. MPL fits in any pocket, making it the perfect companion for everyday work. It features a crush-proof, horizontal vial with a +30% magnifying effect and a luminescent reflector for better readability in dim light conditions. Made in polyamide and reinforced with fiberglass.

- Compact size
- Suitable for horizontal measuring
- Tolerance in normal position is 1.00 mm/m
- Crush-proof block vial with magnifying effect

Stockcode	Length	Qty/pack	Vials
401303 Pocket Level MPL	68 mm	10 pcs	1 pcs



### Mini Pocket Level Magnetic

Hultafors MPL Magnetic is a compact spirit level with a magnet for fast and reliable horizontal and vertical measuring. MPL Magnetic fits in any pocket, making it the perfect companion for everyday work. The strong magnet and V-groove facilitates measurement on flat or curved surfaces, such as pipes, beams etc. It features a crush-proof focus vial with a +30% magnifying effect and a luminescent reflector for faster and better readability in dim light conditions. Made in polyamide and reinforced with fiberglass.

- Compact size
- Suitable for horizontal and vertical measuring
- V-groove for measurement on flat or curved surfaces
- Tolerance in normal position is 0.75 mm/m
- Crush-proof focus vial with magnifying effect

Stockcode	Length	Qty/pack	Vials
401313 Pocket Level Magnetic MPL MAGNETIC	68 mm	10 pcs	1 pcs

### Sparepart Vial - old MST



Stockcode	Qty/pack
402911 SPAREPART VIAL MST L MST	1 pcs



## Straight Edge Level RS

Made from strong aluminium profile measuring 100x18 mm and weighing 870 g/m. Crush-proof block vials that are highly transparent and durable.

- The radius of the vial is 200 mm, giving a sensitivity of 10 mm/m.
- Tolerance in normal position is  $\pm 1.0$  mm/m.
- The liquid in the vial is a low viscosity coloured oil mixture that gives the bubble optimal freedom of movement.
- Highly resistant to ultraviolet light and temperature fluctuations.
- The anti-static properties of the liquid means that the bubble is not affected by static electricity.

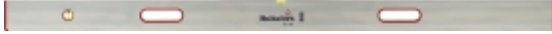

Stockcode	Length	Qty/pack	Vials
403001 SCREEDINGLEVEL RS 180	1800 mm	1 pcs	2 pcs
403101 SCREEDINGLEVEL RS 200	2000 mm	1 pcs	2 pcs
403111 SCREEDINGLEVEL RS 240	2400 mm	1 pcs	2 pcs



## Spirit Level Aluminium Libella 2000

Libella 2000 has a cast and smooth-finished aluminium housing. Crush-proof block vials with very high transparency, durability, a magnifying lens and luminescent reflector. May be supplemented with rails, extensions and gradient wedges – Libella 2000 has a maximum length of 3100 mm, and the option to check inclinations.

- The radius of the vial is 1000 mm, giving a sensitivity of 2 mm/m.
- Tolerance in normal position is  $\pm 0.25$  mm/m, upside down  $\pm 0.75$  mm/m.
- The liquid in the vial is a low viscosity coloured oil mixture that gives the bubble optimal freedom of movement.
- Highly resistant to ultraviolet light and temperature fluctuations.
- The anti-static properties of the liquid means that the bubble is not affected by static electricity.



Stockcode	Length	Qty/pack	Vials
407001 LIBELLA LIBELLA 2000	310 mm	1 pcs	2 pcs

## Spare Parts Libella

Spare parts for the spirit level Libella 2000. By replacing worn out parts you prolong the life span of the Libella.



Stockcode	Qty/pack	Other	Fits to
407011 LIBELLA (RED) SPARE VIAL L2000	1 pcs	Complete vial	407001
407831 LIBELLA SPAREPART SP 2000	1 pcs	Stress plate with nut	407001
407841 LIBELLA SPAREPART SB 600+900	1 pcs	Stress block with wing nut	407001

## Spirit Level Rail Libella

Aluminium spirit level rails with grooves for simple and stepless fitting on Libella 2000. With rails and extensions, LIBELLA 2000 becomes an extendable spirit level with a maximum length of 3100 mm.

- Made from anodised aluminium to prevent your hands or the surrounding area becoming dirty.
- The rail ends are equipped with protective fittings.



Stockcode	Length	Qty/pack	Other
407201 LIBELLA LEVEL BAR L 1200	1200 mm	1 pcs	
407301 LIBELLA LEVEL BAR L 1500	1500 mm	1 pcs	
407401 LIBELLA LEVEL BAR L 1800	1800 mm	1 pcs	
407501 LIBELLA EXTENSION BARS L 600+900	- mm	1 pcs	Extension rail set
407861 END PLUG LEVEL BAR EVS 2000		1 pcs	End plug spirit level rail
407881 END PLUG EXTENSION BAR EFS 2000		1 pcs	End plug extension rail

## Gradient Wedge Libella

With a gradient wedge fitted between the spirit level rail and your Libella 2000, you can check inclines/gradients.

- Made from ABS plastic, which makes the wedge both light and durable.
- Gradient is measured in millimetres per metre and the gradient wedge has 20 steps between 2 and 40 mm/m.
- Simply attaches to the spirit level rail using a strong steel wing nut.



Stockcode	Qty/pack
407601 LIBELLA GRADIENT SETTER F 2-40	1 pcs

## Spirit Level Plastic GDS

An impact resistant spirit level made from red polystyrene plastic that withstands temperatures between  $-15^{\circ}\text{C}$  and  $+60^{\circ}\text{C}$ . Crush-proof block vials with very high transparency and durability. Horizontal vial with a magnification lens and luminescent reflector. Easy to clean off cement.

- The radius of the vial is 200 mm, giving a sensitivity of 10 mm/m.
- Tolerance in normal position is  $\pm 1.0$  mm/m.
- The liquid in the vial is a low viscosity coloured oil mixture that gives the bubble optimal freedom of movement.
- Highly resistant to ultraviolet light and temperature fluctuations.
- The anti-static properties of the liquid means that the bubble is not affected by static electricity.



Stockcode	Length	Qty/pack	Vials
401503 SPIRIT-LEVEL GDS 40	400 mm	1 pcs	2 pcs
401603 SPIRIT-LEVEL GDS 60	600 mm	1 pcs	2 pcs





### Torpedo Spirit Level Plastic TVP

An impact resistant spirit level made from red polystyrene plastic that withstands temperatures between  $-15^{\circ}\text{C}$  and  $+60^{\circ}\text{C}$ . Crush-proof block vials with very high transparency and durability. Horizontal vial with luminescent reflector. Has a V-groove in the bottom to allow use on pipes.

- The radius of the vial is 200 mm, giving a sensitivity of 10 mm/m.
- Tolerance in normal position is  $\pm 1.0$  mm/m.
- The liquid in the vial is a low viscosity coloured oil mixture that gives the bubble optimal freedom of movement.
- Highly resistant to ultraviolet light and temperature fluctuations.
- The anti-static properties of the liquid means that the bubble is not affected by static electricity.

Stockcode	Length	Qty/pack	Vials
401803 SPIRIT-LEVEL TVP 25	250 mm	5 pcs	2 pcs



### Torpedo Spirit Level Plastic TVP Magnetic

An impact resistant spirit level in red ABS plastic with magnets on the underside. Crush-proof tubular vials that are highly transparent and durable.

- The radius of the vial is 150 mm, giving a sensitivity of 13 mm/m.
- Tolerance in normal position is  $\pm 1.5$  mm/m.
- The liquid in the vial is a low viscosity coloured oil mixture that gives the bubble optimal freedom of movement.
- Highly resistant to ultraviolet light and temperature fluctuations.
- The anti-static properties of the liquid means that the bubble is not affected by static electricity.

Stockcode	Length	Qty/pack	Vials
401853 SPIRIT-LEVEL TVP MAGNET 20	200 mm	5 pcs	3 pcs



### Spirit Level Cordinat

Spirit level made from a durable aluminium profile with graduations, four adjustable sliders and two tubular vials. Can be used for measuring, horizontal and vertical reading and distance marking. Ideal for applications such as hanging cupboards. Tolerance in normal position is  $\pm 0.5$  mm/m, upside down  $\pm 0.75$  mm/m.

- Transfer measured distances using the sliders.
- Position the measure distance on the wall and adjust using the vials.
- Easy centring using the zero point in the middle of the scale.
- The vials are highly resistant to ultraviolet light and fluctuations in temperature.
- The anti-static properties of the liquid means that the bubble is not affected by static electricity.

Stockcode	Length	Qty/pack	Vials
408604 SPIRIT-LEVEL CORDINAT	800 mm	10 pcs	2 pcs



### Post Level JP

Post spirit level made from impact resistant ABS plastic, with three crush-proof tubular vials fitted to allow both horizontal and vertical measurement.

- The crush-proof vials have a radius of 180 mm, giving a sensitivity of 11 mm/m.
- The liquid in the vial is a low viscosity coloured oil mixture that gives the bubble optimal freedom of movement.
- Tolerance in normal position is  $\pm 2.0$  mm/m.

Stockcode	Qty/pack	Vials	Dimensions (LxW)
404403 POLE SPIRIT LEVEL JP	5 pcs	3 pcs	9x14 cm



### Inclinometers NAM, APN, NP

The inclinometer is made from a strong aluminium profile measuring 50x23 mm and weighing around 740 g/m. It has a 360° measurement range, split into four 90° arcs. The tool shows a gradient of 0–100%. Crush-proof block vials that are highly transparent and durable.

- The radius of the vial is 200 mm, giving a sensitivity of 10 mm/m.
- Tolerance in normal position is  $\pm 0.5$  mm/m = 0.03°.
- The liquid in the vial is a low viscosity coloured oil mixture that gives the bubble optimal freedom of movement.
- Highly resistant to ultraviolet light and temperature fluctuations.
- The anti-static properties of the liquid means that the bubble is not affected by static electricity.

Stockcode	Qty/pack	Vials	Magnets	Length
402101 INCLINOMETER NAM 13	1 pcs	1 pcs	1 pcs	130mm
402201 INCLINOMETER NAM 50	1 pcs	1 pcs	2 pcs	500mm
402301 INCLINOMETER APN 60	1 pcs	1 pcs		600mm
402401 INCLINOMETER NP 121	1 pcs	1 pcs		130x130mm



### Inclinometers APK

Inclinometer with adjustable measurement piston, graduated up to an inclination of 10%. Made from strong aluminium profile measuring 50x24 mm and weighing 740 g/m. Crush-proof block vials that are highly transparent and durable. Horizontal vial with a magnification lens and luminescent reflector.

- The radius of the vial is 200 mm, giving a sensitivity of 10 mm/m.
- Tolerance in normal position is  $\pm 0.5$  mm/m.
- The liquid in the vial is a low viscosity coloured oil mixture that gives the bubble optimal freedom of movement.
- Highly resistant to ultraviolet light and temperature fluctuations.
- The anti-static properties of the liquid means that the bubble is not affected by static electricity.

Stockcode	Length	Qty/pack	Vials
402501 SPIRIT-LEVEL APK 100	1000 mm	1 pcs	1 pcs
402511 SPAREPART WATER LEVEL ADJUSTER PIN		1 pcs	
402521 SPAREPART SPIRIT LEVEL SQUARE SP		1 pcs	
402531 SPAREPART SPIRIT LEVEL SQUARE		1 pcs	
402541 SPAREPART WATER LEVEL SCREW APK			



### Hose Water Level S

Spirit level in two sections that you attach to either end of a hose, which is then filled with water. Suitable for checking the incline of larger surfaces.

- Made from acrylic glass, making them both light and durable.
- The bleed screws are made from brass in order to be highly resistant to corrosion.
- Fits two sizes of hose – 10 and 12 mm.
- The scale runs from 0–165 mm.

Stockcode	Qty/pack	Scale	Hose dimensions
402603 WATER-LEVEL S 1012	5 pcs	0-165 mm	10 & 12 mm



### Hose Water Level SP

Spirit level in two sections that you attach to either end of a hose, which is then filled with water. Suitable for checking the incline of larger surfaces.

- Made from ABS plastic, which makes them both light and durable.
- Fits two sizes of hose – 10 and 12 mm.
- The scale runs from 0-50-0 mm.

Stockcode	Qty/pack	Scale	Hose dimensions
402653 WATER-LEVEL SP 20	3 pcs	0-50-0 mm	10 & 12 mm



### Line Spirit Level UZ

Small, neat line spirit level made from impact resistant plastic with a vial and hooks at both ends. Hang the level on a tensioned string to check the incline between two points.

- Made from ABS plastic, which makes the level both light and durable.
- The tubular vial is made from Plexiglas.
- The liquid in the vial is a low viscosity coloured oil mixture that gives the bubble optimal freedom of movement.

Stockcode	Length	Qty/pack
402804 SPIRIT-LEVEL UZ 8	80 mm	10 pcs



### Cross Spirit Level K

Spirit level in red impact resistant plastic with two perpendicular vials. Suitable for checking the incline of two dimensions at the same time.

- Made from ABS plastic, which makes the level both light and durable.
- The tubular vials are made from Plexiglas.

Stockcode	Qty/pack	Vials
402004 SPIRIT-LEVEL K 5	10 pcs	2 pcs

### Mini Spirit Level R 102

Fitted in position with glue.

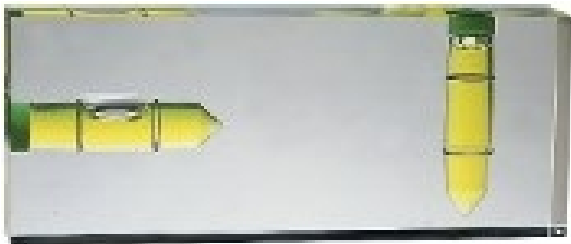

Stockcode	Qty/pack	Dimensions ( LxWxH)
403501 SPIRIT-LEVEL R 102	1 pcs	95x50x15 mm

### Block Vial NV 702

Fitted in position by two screws.

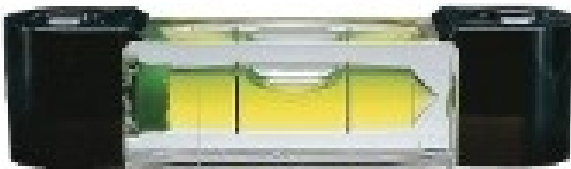

Stockcode	Qty/pack	Dimensions ( LxWxH)
403801 VIAL NV 702	1 pcs	70x15x17 mm



### Block Vial FV 40

Fitted in position with glue.

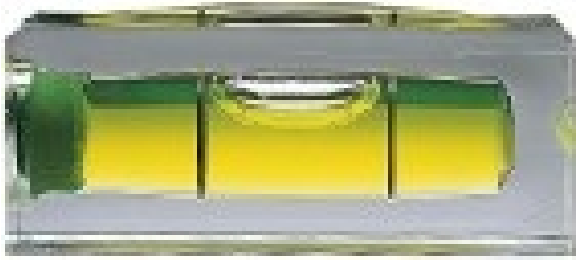

Stockcode	Qty/pack	Dimensions ( LxWxH)
404201 VIAL FV 40	1 pcs	40x15x17 mm

### Bull's Eye Level 701

Fitted in position with glue.



Stockcode	Qty/pack	Dimensions
404601 CIRCULAR VIAL 701	1 pcs	Ø12.8, H=9mm

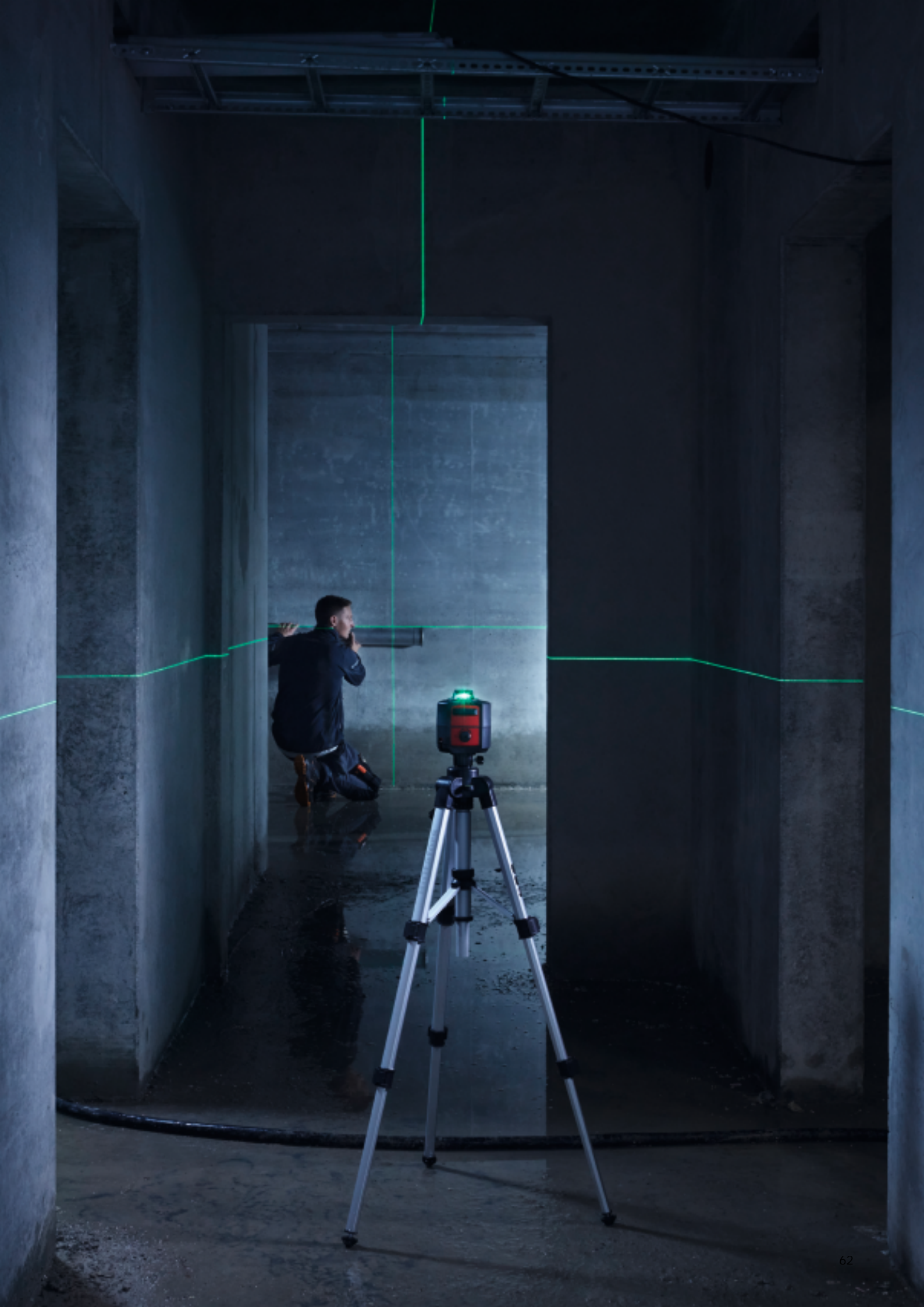

# Surrounded by lasers.

## USER-FRIENDLY PERFECTION.

Hultafors offers a wide range of intuitive laser tools with red or green laser. In addition, we have several practical distance meters that facilitate work in spaces that are difficult to access as well as in large spaces. All products in our laser range focus on ease of use. Setting up and starting work should go quickly.

### H360G GREEN CROSS LASER

Green laser for clearer readings with levelling ability up to 25 m both horizontally and vertically.

Horizontal 360° laser line.

Tolerance 0.2 mm/m.

Height-adjustable wall mount included.



Reaches up to 80 m with Hultafors RECG receiver.

Use with Li-Ion battery or AA+ batteries.

### Wide selection.

MAKE YOUR WORK MORE EFFICIENT.

Our range of laser tools includes both red laser and green laser in several different models depending on the work to be done. Of course, they are all equally easy and precise to read. Our laser products make the work efficient and smooth thanks to the user-friendly design. Laser tools are perfect to use when exact dimensions are required on larger surfaces, such as for pipe and cable routing, tiling, wall cabinet mounting or for wall-papering.

### Laser accessories.

COMPATIBLE WITH MOST LASER MEASUREMENT TOOLS.

Our laser range also includes a number of flexible accessories designed to make working with our laser tools easier. For poor lighting conditions or long distances, our laser tools can be supplemented with a receiver to make reading easier. We also have compact lightweight tripods universal brackets for smooth and easy mounting on different surfaces.



### 3X360 CROSS LASER - H3x360

Compact line laser with one horizontal and two vertical 360° lines and a measuring tolerance of just 0.2 mm/m. Together with the horizontal 360° laser line, the vertical lines form a 90° angle, which form a wall cross, ceiling cross or floor cross at their intersections. The laser lines can each be switched on individually at the touch of a button. It is ideal for a wide range of tasks, such as plumbing, tiling, putting up wallpaper or setting reference markers at the floor and in the ceiling. It fits with Hultafors Universal holder and tripod for easy height adjustment.

- Projects 360° horizontal and vertical laser lines.
- Measuring tolerance is 0.2 mm/m.
- Projects 360° horizontal and vertical laser lines.
- 4 x 1,5 V (AA) batteries included.
- Compatible with the Hultafors Receiver for usage up to 80 m.

Stockcode	Width	Height	Depth	Qty/pack	Weight
409180 3x360 CROSS-LASER H3x360	100 mm	110 mm	130 mm	1 pcs	730 g



### Horizontal Cross-line laser Green

The H360G is a green cross laser that has levelling ability up to 25 metres horizontally and vertically (80m with receiver RECG). The vertical line forms a 90° angle together with the horizontal 360° laser line. The pendulum can be locked, and the fine adjustment feature enables it to be rotated horizontally and vertically for desired angles. The visibility of green laser lines is up to four times better than red laser. Can be used with Li-Ion battery or AA+ batteries. Not included.

- Horizontal 360° laser line.
- Measuring tolerance 0,2 mm/m.
- Height-adjustable wall mount included.
- Compatible with the Hultafors Receiver RECG for usage up to 80 m.
- Delivered in a protective case.

Stockcode	Width	Height	Depth	Qty/pack	Weight
409170 360 CROSS-LASER GREEN H360G	100 mm	125 mm	100 mm	1 pcs	650 g



### CROSS LASER GREEN SET

Compact and user friendly green cross laser with high accuracy. The green laser lines are up to four times more visible than red to improve accurate and fast reading. The base of the product is possible to rotate in 360° in order to improve the adjustment of the product. The pendulum of the product can be locked in order to project lines in every desired angle. Ideal when tiling, putting up wallpapers or hanging cabinet's etc.

- Green laser for better visibility than red laser.
- Measuring tolerance 0,2 mm/m.
- Li-Ion battery and charger included.
- Compatible with the Hultafors Receiver RECG for usage up to 80 m.
- Delivered in a protective case.

Stockcode	Width	Height	Depth	Qty/pack	Weight
409160 CROSS-LASER GREEN HXLG-S	65 mm	120 mm	105 mm	1 pcs	494 g





### Cross-line laser

Compact and user friendly cross laser with high accuracy. Bright very visible laser lines to improve accurate and fast reading when tiling, putting up wallpapers or hanging cabinet's etc. The base of the product is possible to rotate in 360° in order to improve the adjustment of the product. The pendulum of the product could be locked in order to project lines in every desired angle. When in PULSE-mode the laser is compatible with Hultafors receiver REC for usage up to 80m. The tolerance is 0,2 mm/m. The power supply is 3 x 1,5 V (AA)batteries.

- Wave length: 635 nm
- Laser class: 2M
- Protection class: IP54
- Operating temperature: 10°C to 50°C
- Self levelling range: +/- 4°

Stockcode	Width	Height	Depth	Qty/pack	Weight
409120 CROSS-LINE LASER HXL	65 mm	120 mm	105 mm	1 pcs	494 g



### Point & Cross-line laser

User friendly point cross laser with high precision laser lines for high accurate and fast reading to improve efficiency when making walls and transferring heights. The plumb point combined with the rotational combination holder makes it easy to position the laser above a reference point and/or beam. PXL also projects lines in the sealing above the product to show the position of the plumb point. The pendulum of the product could be locked in order to project lines in every desired angle. When in PULSE-mode the laser is compatible with Hultafors receiver REC for usage up to 80m. The PXL projects 2 crosses in 90° relation. The tolerance is 0,2 mm/m, the power supply is 3 x 1,5 V (AA)batteries.

- Wave length: 3 x 520 nm, 1 x 650 nm
- Laser class: 2
- Protection class: IP54
- Operating temperature: -10° to +50°
- Self levelling range: +/-4°

Stockcode	Width	Height	Depth	Qty/pack	Weight
409130 LINE & POINT LASER PXL	103 mm	115 mm	135 mm	1 pcs	602 g



# Smart distance measurer.

## SIMPLE PRECISION.

With our range of distance measurers, as with all our other tools, there is strong focus on user-friendliness. They help to make work easy. Their design is compact and robust and they are very easy to use when measuring hard-to-reach spaces and at longer distances.

### HDL 100 DISTANCE METER

Measure distance and calculate area and volume.



## Smart technology.

THERE IS AN APP FOR IT.

Our distance measurers are available in three different models where the HDL 100-S is our most advanced model. It comes with integrated Bluetooth and camera function with 2 and 4x zoom to make accurate distance measurements. It also has a backlit touch screen which helps in poor lighting conditions.

HDL 100-S also has an app for smartphones, where all dimensions can be easily stored. It is also possible to transfer dimensions for drawing up a room. It is also possible to calculate surface areas on ceilings and walls and measure volume.







### LASER DISTANCE METER HDL 100

HDL100 has the latest technology in a compact and handy format. Integrated Bluetooth, camera-function and user-friendly touchscreen. Transfer measurements quick and easy to the HDL100 app. The camera has 2 and 4 x zoom to make measuring in long distance easier. Integrated inclination sensor for levelling and angle measurements. Use for length distance, cables and pipes, surface measurement of ceiling and walls and volume measurements. East to measure indirect 2-point or 3-point measurement, MIN/MAX measurement or continuous measurement.

- Bluetooth och App for smartphone or ipad/tablet.
- Backlit touchscreen in color
- Tolerance is +/- 1,5 mm
- Built in camera with 2 or 4 x zoom
- Belt pouch and tripod included.

Stockcode	Width	Height	Depth	Qty/pack	Weight
409150 LASER DISTANCE METER HDL 100-S	50 mm	115 mm	25 mm	1 pcs	148 g



### Laser Distance meter

Intuitive and user friendly distance measurer with a measuring range up to 80m. High precision, compact design and soft case in order to increase mobility and storage in belt. A backlit display in order to increase readability in dark surroundings. Typical applications is measurement of longer distances, cables/pipes, calculation of surfaces and volumes & in places hard to access. HDL is also suitable for indirect 2 or 3 point measurements. The tolerance is 1,5 mm, and the measurement range is 20 cm to 80 m.

- Wave length: 635 nm
- Laser class: 2
- Protection class: IP54
- Power supply: 2 x 1,5 V (AAA) batteries
- Operating temperature: 0°C to +40°C

Stockcode	Width	Height	Depth	Qty/pack	Weight
409110 LASER DISTANCE METER HDL 80	52 mm	115 mm	32 mm	1 pcs	308 g



### LASER DISTANCE METER HDL 20

Intuitive and user-friendly distance measurer with a measuring range up to 20 m. High precision in compact design, making it easy to carry in pocket. A backlit display in order to increase readability in dark surroundings. Typical applications are measurement of distances, cables/pipes, calculation of surfaces for volumes or in places hard to access.

- Small and easy to use.
- Backlit display.
- Tolerance is +/- 2 mm.
- Measurement range 20 cm till 20 m.
- Perfect for usage in narrow spaces.

Stockcode	Width	Height	Depth	Qty/pack	Weight
409140 LASER DISTANCE METER HDL 20	38 mm	100 mm	25 mm	1 pcs	70 g



# Reach a little further.

ACCESSORIES THAT MAKE THE JOB MORE EFFICIENT.

Our laser range also includes a variety of accessories that complement and facilitate work with the laser tools. Everything from goggles that enhance the laser line and make reading easier to different universal brackets, tripods and receivers.

## REC/RECG RECEIVER

Used for easy reading of a laser line at long distance or in non-optimal light conditions.



### Succinct.

FOR PRECISE READINGS.

Our receiver can be used for distances from 1 m up to 80 m. The receiver is equipped with displays on both sides to facilitate reading. The back of the receiver is magnetic so that it can be mounted quickly and easily on metal bars, for example. Two vials ensure that the receiver is positioned straight. When used in noisy environments, the volume can easily be adjusted between three different levels.

### Everything you need.

MAKES THE WORK DAY EASY.

All our accessories in the laser range are there to make the work day more efficient. In addition to accessories that facilitate laser line reading, the range also includes Li-Ion batteries and chargers, as well as various mounting brackets and tripods. For a sharper reading there are also target boards and laser goggles for both red and green lasers.





### RECEIVER

Hultafors REC and RECG are used for easier reading of laser lines at long distance or in non-optimal light conditions. To simplify reading of laser lines at different distances the receiver can be set at two levels of sensibility; "Rough" ( $\pm 2.00$  mm) and "Fine" ( $\pm 0.50$  mm). The volume can be adjusted between three levels to be able to hear the signal even when used in noisy environments. The receivers are equipped with displays on both sides to simplify the reading. Two vials make sure that the receiver is positioned straight.

- Two levels of sensibility, Rough/Fine.
- Use for reading of laser lines at long distance
- Backlit displays.
- Magnetic mounting.
- Compatible with products with PULSE-function.

Stockcode	Width	Height	Depth	Qty/pack	Weight
409103 RECIEVER GREEN RECG	70 mm	195 mm	30 mm	1 pcs	260 g
409091 RECIEVER REC	70 mm	195 mm	30 mm	1 pcs	260 g



### TRIPOD B-10

Compact and light weight tripod in order to increase mobility. The tripod can be placed on all types of surfaces and fits into narrow spaces where larger tripod does not suit. The adjustable tilt head are easy to adjust and has a working height of 14 cm. Hultafors B-10 Tripod fits most lasers with 1/4" attachment.

- Compatible with all Hultafors lasers.
- Rubber feet to secure placement.
- Compact design.
- Vertical fine tuning.
- Carries up to 1 kg.

Stockcode
409098 TRIPOD B-10

### Tripod



Compact and light weighted tripod made of robust aluminum, saving space when transported. The tripod is safe and stable and can be placed on all types of surfaces. It is easy to adjust and has a working height between 42 and 120 cm. Hultafors B-120 Tripod fits most lasers with 1/4" attachment, preferably for Hultafors HXL and PXL.

Stockcode	Qty/pack	Working height
409093 TRIPOD/STATIV B-120	1 pcs	42-120cm



## Universal holder



Universal bracket for our lasers. The height of the bracket is adjustable and can be used for 360 degrees rotation, simplifying the alignment of the laser. The bracket has magnets which makes it easier to mount the laser. It is also possible to hang the bracket on a screw or nail. Hultafors UH fits most lasers with ¼ " attachment and preferably for Hultafors HXL and PXL.

Stockcode	Qty/pack
409096 UNIVERSAL HOLDER UH	1 pcs

## Magnetic holder



Universal bracket with magnets for easy mounting of our lasers. The bracket can easily be hung on a screw or nail. MAH fits most lasers with ¼" attachment, preferably for Hultafors HXL and PXL.

Stockcode	Qty/pack
409097 MAGNETIC HOLDER MAH	1 pcs

## LASER GOGGLES



Goggles that make it easier for you to see and focus the laser line. Essential for working in areas where there is a lot of light that make it difficult to see the laser lines. This is not laser protection glasses.

- Available with red lenses for red laser.
- Available with green lenses for green laser.
- Comfortable design.

Stockcode	Qty/pack
409106 LASER GOGGLES GREEN LBG	1 pcs
408121 LASER GOGGLES RED LB	1 pcs





## TARGET PLATE

Laser target plate for an easier and clearer reading of laser lines. Hultafors TP/TPG is magnetic and also has a hole, making it easy to mount on a wall or rule.

- Small size, fits easy in pocket.
- Clearer reading of laser lines.
- Supporting leg for easy placement.
- Magnetic for easy mounting.

Stockcode	Qty/pack
409104 TARGET PLATE GREEN TPG	1 pcs
409094 TARGET PLATE TP	1 pcs

## LI-ION BATTERY



Rechargeable Li-Ion battery for extended working time. The Li-Ion battery gives full performance and a good visibility of the laser line till the end of the charge. The Li-Ion batteries have lower self-discharging and have no memory effect to extend the battery life time. HRB can be used in HXL, HXLG, PXL and H360G.

- Long lifespan.
- Low self-discharging.
- Charging time 3-5 h.

Stockcode	Width	Height	Depth
409101 LI-ION BATTERY HRB	39 mm	71 mm	22 mm

## LI-ION CHARGER



Li-Ion battery charger. The charger has a short charging time. HRBC can be used to charge the HRB used in HXL, HXLG, PXL and H360G.

- Fits Hultafors HRB.
- Charging time: 3-5 h

Stockcode
409100 LI-ION CHARGER HRBC

## LI-ION CAR CHARGER



Li-ion battery charger. Charge the battery quick and easy on your way to the worksite.

- Fits Hultafors HRB.
- Short charging time.

Stockcode
409102 LI-ION CAR CHARGER HRBCC

## LI-ION SET including battery



Rechargeable Li-ion battery set with charger for extended working time. The Li-ion battery gives full performance and a good visibility of the laser line till the end of the charge. The Li-ion batteries has lower self-discharging and no memory effect to extend the battery life time. HRB can be used in HXL, HXLG, PXL and H360G.

- Long lifespan.
- Low self-discharging.
- Charging time 3-5 h.

Stockcode
409099 LI-ION SET HRB-S

## Adapter set

Adapter designed to convert 1/4" to 5/8" and 5/8" to 1/4".



Stockcode	Qty/pack
409095 ADAPTER SET LA-2	1 pcs



## Battery adapter

This battery adapter is a spare part that fits Hultafors HXL and PXL. The adapter holds 3 AA batteries.



Stockcode	Qty/pack
409092 BATTERY ADAPTER BA	1 pcs

## Protection Bag Levels

Protective case made from durable nylon for laser and digital spirit levels. Length 600 mm.

- Made from highly durable nylon.
- Wide and adjustable shoulder strap.
- Fits Laser Spirit Level LWX, Digital Laser Spirit Level ELWX and Digital Spirit Level DM.



Stockcode	Qty/pack	Fits to
408402 BAG LEVELS 60 CM V 60	1 pcs	ELWX, LWX, DM







# Developed with pros.

## THE NEXT GENERATION OF HAMMERS.

Our hammers are developed together with professional users, enabling us to deliver tools that can be relied on – by all professions. This has enabled us to develop an extensive assortment of hammers, offering claw hammers as well as special hammers, for example: carpenter's hammers, electrician's hammers and bricklayer's hammers. They have all been developed to fill one purpose – to streamline the working day without compromising the ergonomics.

### CLAW HAMMER TC

Forged in one piece.



reddot design award  
winner 2008

### Ergonomic design.

DEVELOPED WITH YOUR BODY IN MIND.

Our hammers are developed with your body in mind. For us it's as important that the hammer head is causing as little vibration as possible, as it is to design an ergonomic shaft in a variety of sizes. This enables you to choose a hammer that gives you a relaxed grip and causes less strain on the body. The difference is also noticeable in the long term, as the technology reduces the risk of stress-related injuries.

### A sustainable choice.

EXTEND THE LIFE SPAN OF THE HAMMER.

Several of our hammers are made with wood handles. This is not only a traditional way of making a hammer, it is also extending the life span of the product. The wooden shafts are made of hickory, a strong and flexible wood. They are available as a spare part, meaning that as long as the hammer head is in good condition you can replace the shaft when the old one is worn out, extending the life span of the hammer.



### Claw Hammer TC

An ergonomically designed hammer, forged in one piece for increased durability with a vibration damping urethane plug. Thin, strong claw that affords easy access without leaving marks. The claw opening and angle give the best possible grip on the nail. Ergonomically designed handle with clear end stop and a secure grip.

- Vibration damping urethane plug.
- Right angle and shape of striking face.
- Steel shaft with I-profile for increased durability.
- Thin, strong claw that affords easy access without leaving marks. In addition, the claw is rounded to prevent it tearing your trousers.

Stockcode	Qty/pack	Total weight	Handle
820110 CLAW HAMMER TC 16 L	2 pcs	720 g	Large
820120 CLAW HAMMER TC 16 XL	2 pcs	720 g	X-Large
820130 CLAW HAMMER TC 20 L	2 pcs	795 g	Large
820140 CLAW HAMMER TC 20 XL	2 pcs	795 g	X-Large



### Claw Hammer TR

An ergonomically designed hammer, forged in one piece for increased durability with a vibration damping urethane plug. Thin, strong claw that affords easy access without leaving marks. The claw opening and angle give the best possible grip on the nail. Ergonomically designed handle with clear end stop and a secure grip.

- Vibration damping urethane plug.
- Right angle and shape of striking face.
- Steel shaft with I-profile for increased durability.
- Thin, strong claw that affords easy access without leaving marks. In addition, the claw is rounded to prevent it tearing your trousers.
- The TR has a straight claw for better access and a longer shaft for more power for more demanding applications.

Stockcode	Qty/pack	Total weight	Handle
820220 RIP HAMMER TR 16 XL	2 pcs	740 g	X-Large
820240 RIP HAMMER TR 20 XL	2 pcs	810 g	X-Large



### Claw Hammer TS

Ergonomically designed hammer with a thin, strong claw that affords easy access without leaving marks. The claw opening and angle give the best possible grip on the nail.

- Right angle and shape of striking face for optimal working conditions.
- The claw opening and angle give the best possible grip on the nail.
- Thin, strong claw affords easy access without leaving marks.
- The claw is rounded to prevent it tearing your work trousers.
- Ergonomically designed and ribbed handle for optimal grip.

Stockcode	Qty/pack	Total weight	Handle
820006 CARPENTER'S HAMMER TS 16	2 pcs	720 g	S
820008 CARPENTER'S HAMMER TS 20	2 pcs	800 g	S



## Claw Hammer HSH



Claw hammer with steel tube shaft.

- 2-component handle for efficient grip.

Stockcode	Qty/pack	Total weight	Handle
866002 CLAWHAMMER HOBBY HSH 16	2 pcs	720 g	S

## Claw Hammer KP



A powerful carpenter's hammer with spike and square striking face. The shaft is fitted to the head using steel rails.

- The hammer head is hand-forged with a tempered striking face and claw.
- The wooden shaft is available as a spare.
- Steel rails for fitting the shaft are available as spares.

Stockcode	Qty/pack	Total weight	Handle
820066 CARPENTER'S HAMMER KP 650	2 pcs	800 g	Hickory
820065 CARPENTER'S HAMMER KP 750	2 pcs	900 g	Hickory
820070 SPAREPART KP 650,750 KPS RAILS	1 pcs		-

## Claw Hammer EL



A versatile hammer with a U-shaped striking face. The U-shape makes it possible to work close to ceilings and corners without leaving marks on surrounding surfaces. Ideal for working in narrow spaces.

- The U-shaped striking face makes it possible to drive nails into surfaces close to ceilings and corners.
- The straight claw makes it easy to get at and remove nails and clamps in narrow spaces.
- Ergonomically designed handle affords good grip along the entire shaft, regardless of power or precision required.

Stockcode	Qty/pack	Total weight	Handle
820040 ELECTRICIAN'S HAMMER EL	2 pcs	550 g	S

## Joiner's Hammer SH



A small hammer with a square face and cross pein and a hickory shaft.

- The hammer head is hand-forged with a tempered pein and striking face.
- The forging conforms to the requirements of DIN 1041.
- The wooden shaft is available as a spare.

Stockcode	Qty/pack	Total weight	Handle
822001 JOINER'S HAMMER SH 200	2 pcs	250 g	Hickory
822002 JOINER'S HAMMER SH 250	2 pcs	325 g	Hickory
822003 JOINER'S HAMMER SH 400	2 pcs	500 g	Hickory

## Nail Puller Atle



A versatile and easy-to-use nail puller. Despite its small size, it can easily pull out a 5-inch nail, even when the head is off or buried deep in the wood.

- You use it together with your carpenter's hammer and pull using the claw.
- Made from red painted steel.

Stockcode	Length	Qty/pack	Weight
820030 NAIL PULLER ATLE	200 mm	1 pcs	580 g
820039 ATLE SPARE PART SPARE SCREW SET		1 pcs	20 g

## Hammer Holder HMRH



Smart hammer holder with ergonomic design. Ergonomically-angled design prevents the hammer-handle from striking your leg when walking, or getting in the way when bending down on your knees. The angle also makes it easy to access the hammer. Easy to attach to trousers, a belt or a tool vest. Made in extra strong, yet flexible thermoplastic that will not damage delicate surfaces.

- Ergonomic design for comfortable use.
- Easy access to the hammer.
- Easy to attach to trousers, belts or tool vest.
- Works with most hammers on the market.
- Made in extra strong, yet flexible thermoplastic.

Stockcode	Qty/pack
592000 HAMMER HOLDER HMRH	10 pcs

## Bricklayer's Hammer M

Blasted and clear-lacquered ironwork, with tempered square striking face and wide, ground chisel. Notch for pulling nails and a hickory shaft.

- The hammer head is hand-forged with a tempered chisel and striking face.
- The wooden shaft is available as a spare.



Stockcode	Qty/pack	Total weight	Handle
822241 BRICKLAYER'S HAMMER M 500	2 pcs	680 g	Hickory
822251 BRICKLAYER'S HAMMER M 600	2 pcs	820 g	Hickory

## Bricklayer's Hammer MR

Blasted and clear-lacquered ironwork, with tempered square striking face and ground chisel. Steel shaft with ergonomically designed and ribbed handle for optimal grip.

- The hammer head is hand-forged with a tempered chisel and striking face.
- The shaft is made from steel and has a ribbed rubber handle that affords good grip.



Stockcode	Qty/pack	Total weight	Handle
822261 BRICKLAYER'S HAMMER MR 500	2 pcs	820 g	S



## Bricklayer's Hammer TB

An ergonomically designed hammer, forged as one piece for increased durability with a vibration damping urethane plug. Tempered square striking face and a strong ground chisel with a notch for pulling out nails.

- Right angle and shape of chisel for safe splitting of bricks.
- Steel shaft with I-beam for increased durability.
- Vibration damping urethane plug.
- Handle with a distinct end stop to ensure a secure grip.



Stockcode	Qty/pack	Total weight	Handle
822281 BRICKLAYER'S HAMMER TB 600	1 pcs	900 g	S

## Combi Hammer T-Block



**Ergonomically designed hammer that increases precision and reduces tiredness. The head is filled with steel balls that dampen shock and reduce recoil. Counterweights in the shaft inhibit rotation.**

- Ergonomically designed handle that affords good grip along the entire shaft.
- The head is filled with steel ball bearings that dampen vibrations and reduce recoil.
- Counterweights in the shaft inhibit rotation and improve balance and hammer control.
- Replaceable nylon striking face available as a spare.

Stockcode	Qty/pack	Total weight	Handle	Spare strikers
821259 T-BLOCK COMBI C 250 S	2 pcs	550 g	S	821266 .
821262 T-BLOCK COMBI C 375 M	2 pcs	650 g	S	821267 .
821264 T-BLOCK COMBI C 600 L	2 pcs	900 g	S	821268 .

## Pein Hammer T-Block



**Ergonomically designed hammer that increases precision and reduces tiredness. The head is filled with steel balls that dampen shock and reduce recoil. Counterweights in the shaft inhibit rotation.**

- Ergonomically designed handle that affords good grip along the entire shaft.
- The head is filled with steel ball bearings that dampen vibrations and reduce recoil.
- Counterweights in the shaft inhibit rotation and improve balance and hammer control.

Stockcode	Qty/pack	Total weight	Handle
821159 T-BLOCK CROSS PEIN HAMMER P 250 S	2 pcs	550 g	S
821162 T-BLOCK CROSS PEIN HAMMER P 375 M	2 pcs	650 g	S
821164 T-BLOCK CROSS PEIN HAMMER P 600 L	2 pcs	900 g	S

## Ball Pein Hammer T-Block



**Ergonomically designed hammer that increases precision and reduces tiredness. The head is filled with steel balls that dampen shock and reduce recoil. Counterweights in the shaft inhibit rotation.**

- Ergonomically designed handle that affords good grip along the entire shaft.
- The head is filled with steel bearings that dampen vibrations and reduce recoil.
- Counterweights in the shaft inhibit rotation and improve balance and hammer control.

Stockcode	Qty/pack	Total weight	Handle
821059 T-BLOCK BALL PEIN HAMMER K 250 S	2 pcs	550 g	S
821062 T-BLOCK BALL PEIN HAMMER K 375 M	2 pcs	650 g	S
821064 T-BLOCK BALL PEIN HAMMER K 600 L	2 pcs	900 g	S





## Pein Hammer AB

Blasted and clear-lacquered ironwork, with tempered striking face and extended pein. Hickory shaft.

- The hammer head is hand-forged with a tempered pein and striking face.
- The wooden shaft is available as a spare.

Stockcode	Qty/pack	Total weight	Handle
821003 CROSS PEIN HAMMER AB 150	2 pcs	200 g	Hickory
821004 CROSS PEIN HAMMER AB 200	2 pcs	300 g	Hickory
821005 CROSS PEIN HAMMER AB 300	2 pcs	400 g	Hickory
821006 CROSS PEIN HAMMER AB 400	2 pcs	500 g	Hickory
821007 CROSS PEIN HAMMER AB 600	2 pcs	700 g	Hickory



## Ball Pein Hammer XK

Blasted and clear-lacquered ironwork, with tempered striking face and polished ball. Hickory shaft.

- The hammer head is hand-forged with a tempered striking face and polished ball.
- The wooden shaft is available as a spare.

Stockcode	Qty/pack	Total weight	Handle
821051 BALL PEIN HAMMER XK 150	2 pcs	200 g	Hickory
821052 BALL PEIN HAMMER XK 200	2 pcs	300 g	Hickory
821053 BALL PEIN HAMMER XK 300	2 pcs	400 g	Hickory
821054 BALL PEIN HAMMER XK 400	2 pcs	500 g	Hickory
821055 BALL PEIN HAMMER XK 500	2 pcs	600 g	Hickory



## Blacksmith's Hammer Z

Blasted and clear-lacquered ironwork, with tempered pein and striking face. Hickory shaft. Smith's Hammer ZR 1000 has a steel shaft with a rubber grip.

- The hammer head is hand-forged with a tempered pein and striking face.
- The wooden shaft is available as a spare.

Stockcode	Qty/pack	Total weight	Handle
822152 BLACKSMITH'S HAMMER Z 900	2 pcs	1000 g	Hickory
822155 BLACKSMITH'S HAMMER Z 1200	2 pcs	1400 g	Hickory
822156 BLACKSMITH'S HAMMER Z 1500	2 pcs	1700 g	Hickory
822157 BLACKSMITH'S HAMMER Z 2000	2 pcs	2300 g	Hickory
822162 BLACKSMITH'S HAMMER ZR 1000	2 pcs	1375 g	S



### Club Hammer ME

Blasted and clear-lacquered ironwork, with tempered and plane-ground striking face on both sides. Hickory shaft. Club Hammer MER 1200 has a steel shaft with a rubber grip.

- The hammer head is hand-forged with tempered and plane-ground striking faces.
- The wooden shaft is available as a spare.

Stockcode	Qty/pack	Total weight	Handle
822101 CLUB HAMMER ME 1000	2 pcs	1150 g	Hickory
822102 CLUB HAMMER ME 1200	2 pcs	1350 g	Hickory
822103 CLUB HAMMER ME 1500	2 pcs	1650 g	Hickory
822112 CLUB HAMMER MER 1200	2 pcs	1700 g	S



### Club Hammer MH

Blasted and clear-lacquered ironwork, with tempered and plane-ground striking face on both sides. Hickory shaft.

- The hammer head is hand-forged with tempered and plane-ground striking faces.
- The wooden shaft is available as a spare.

Stockcode	Qty/pack	Total weight	Handle
843300 CLUB HAMMER MH 1000	2 pcs	1170 g	Hickory
843301 CLUB HAMMER MH 1500	2 pcs	1700 g	Hickory
843302 CLUB HAMMER MH 2000	2 pcs	2250 g	Hickory



### Club Hammer HHMH

Club hammer with black painted ironwork, with tempered and plane-ground striking face on both sides.

- Steel tube shaft with rubber handle.

Stockcode	Qty/pack	Total weight	Handle
866502 LUMP HAMMER HOBBY HHMH 1250	2 pcs	1200 g	S



## Blacksmith's Hammer SMH

**Blasted and clear-lacquered ironwork, with tempered pein and striking face. Hickory shaft.**

- The hammer head is hand-forged with a tempered pein and striking face.
- The wooden shaft is available as a spare.

Stockcode	Qty/pack	Total weight	Handle
843100 CROSS PEIN HAMMER SMH 1000	2 pcs	1150 g	Hickory
843101 CROSS PEIN HAMMER SMH 1500	2 pcs	1650 g	Hickory
843102 CROSS PEIN HAMMER SMH 2000	2 pcs	2150 g	Hickory



## Bench Hammer B

**Blasted and clear-lacquered ironwork, with tempered pein and striking face. Hickory shaft.**

- The hammer head is hand-forged with a tempered pein and striking face.
- The wooden shaft is available as a spare.

Stockcode	Qty/pack	Total weight	Handle
822050 BENCH HAMMER B 200	2 pcs	300 g	Hickory
822051 BENCH HAMMER B 300	2 pcs	400 g	Hickory
822052 BENCH HAMMER B 400	2 pcs	500 g	Hickory



## Tinsmith's Hammer PR

**Blasted and clear-lacquered ironwork, with tempered pein and striking face. Ergonomically designed and ribbed handle for optimal grip.**

- The hammer head is hand-forged with a tempered pein and striking face.
- The shaft is made from steel and has a ribbed rubber handle that affords good grip.

Stockcode	Qty/pack	Total weight	Handle
822215 TINSMITH'S HAMMER PR 300 M	2 pcs	525 g	S
822216 TINSMITH'S HAMMER PR 400 M	2 pcs	635 g	S

## Tile Hammer PL

Blasted and clear-lacquered ironwork, with tempered pein and square striking face. Hickory shaft.

- The hammer head is hand-forged with a tempered pein and striking face.
- The wooden shaft is available as a spare.



Stockcode	Wedge	Qty/pack	Total weight	Handle
822220 TILE HAMMER PL 100	828600	2 pcs	150 g	Hickory

## Glazier Hammer GMH

Blasted and clear-lacquered ironwork, with a tempered, round striking face. Hickory shaft.

- The hammer head is hand-forged with a tempered pein and striking face.
- The wooden shaft is available as a spare.



Stockcode	Qty/pack	Total weight	Handle
822290 GLAZIER'S HAMMER GMH 150	2 pcs	200 g	Hickory

## Welder's Pick

Small and versatile pick made from steel.



Stockcode	Qty/pack	Total weight	Handle
828231 WELDING HAMMER SV 150	10 pcs	280 g	S





## Dead Blow Hammer DB

Hammer head covered with Urethane and a dead blow function using steel balls to cushion the shock and reduce recoil. Soft faces that is gentle on the work piece and non-sparking due to no exposed metal. Ergonomic handle in fibreglass with grip in Santoprene rubber.

- Soft face, doesn't damage surfaces or equipment.
- Dead blow function uses steel balls to cushion the shock and reduce recoil.
- Ergonomic handle in fibreglass with grip in Santoprene.
- Non-sparking, no exposed metal.
- Flat area on head allows upright storage.

Stockcode	Width	Length	Height	Qty/pack	Total weight	Handle	Handle length	Ø
823411 DEAD BLOW HAMMER DB 600	96 mm	295 mm	50 mm	2 pcs	570 g	Rubber grip	240 mm	43 mm
823412 DEAD BLOW HAMMER DB 1200	128 mm	353 mm	64 mm	2 pcs	1160 g	Rubber grip	282 mm	50 mm
823413 DEAD BLOW HAMMER DB 1600	150 mm	424 mm	74 mm	1 pcs	1650 g	Rubber grip	342 mm	60 mm
823414 DEAD BLOW HAMMER DB 5000	232 mm	975 mm	104 mm	1 pcs	5700 g	Rubber grip	838 mm	88 mm



## Copper Hammer CU

Hammer with copper head and fibreglass shaft. Copper hammers are spark-free and gentle on workpieces.

- Soft copper head is gentle on workpieces.
- For work in spark-free environments.
- Fibreglass shaft affords a greater level of safety and an extended service life.

Stockcode	Qty/pack	Total weight	Handle	Handle length
823031 COPPER HAMMER CU 300	2 pcs	400 g	G	260 mm
823032 COPPER HAMMER CU 1000	2 pcs	1300 g	G	340 mm
823034 COPPER HAMMER CU 2000	2 pcs	2400 g	G	340 mm



## Copper Sledge CU

Sledge with copper head and fibreglass shaft. These sledges are spark-free and gentle on workpieces.

- Soft copper head is gentle on workpieces.
- For work in spark-free environments.
- Fibreglass shaft affords a greater level of safety and an extended service life.

Stockcode	Qty/pack	Weight	Handle	Handle length
823035 COPPER HAMMER CU 3000	1 pcs	3000 g	G	850 mm
823036 COPPER HAMMER CU 4000	1 pcs	4000 g	G	850 mm
823037 COPPER HAMMER CU 5000	1 pcs	5000 g	G	850 mm



### Non-rebound Hammer STFS

Hammer with steel striking head filled with damping steel balls. The head has replaceable nylon strikers (hardness 70 shore) that are gentle on workpieces. Steel shaft with rubber handle.

- The head is filled with steel balls that dampen vibrations and reduce recoil.
- Replaceable nylon strikers (hardness 70 shore) that are gentle on workpieces.
- Replaceable strikers available as spares

Stockcode	Qty/pack	Total weight	Handle	Striker Ø	Spare strikers
823312 RECOILLESS HAMMER STFS 30	2 pcs	595 g	S	30 mm	827547 .
823314 RECOILLESS HAMMER STFS 40	2 pcs	800 g	S	40 mm	827549 .
823315 RECOILLESS HAMMER STFS 50	2 pcs	1145 g	S	50 mm	827551 .
823316 RECOILLES HAMMER STFS 60	1 pcs	1625 g	S	60 mm	827552 .



### Rubber Mallet GU

A mallet with black solid rubber head, hardness 80/90 shore A. Ash shaft.

Stockcode	Qty/pack	Total weight	Handle	Striker Ø
823051 RUBBER MALLET GU 40	2 pcs	165 g	A	35 mm
823052 RUBBER MALLET GU 55	2 pcs	320 g	A	50 mm
823053 RUBBER MALLET GU 65	1 pcs	550 g	A	60 mm
823054 RUBBER MALLET GU 75	1 pcs	820 g	A	70 mm



### Spare Head Combi Hammer T-block

Replaceable nylon strikers that are gentle on workpieces.

Stockcode	Qty/pack	Striker Ø	Fits to
821266 SPARE HEAD T-BLOCK COMBI LSC 250	1 pcs	24 mm	821259
821267 SPARE HEAD T-BLOCK COMBI LSC 375	1 pcs	30 mm	821262
821268 SPARE HEAD T-BLOCK COMBI LSC 600	1 pcs	35 mm	821264

## Non-rebound Hammer STFS, Spare Strikers

Replaceable nylon strikers (hardness 70 shore) that are gentle on workpieces.



---

Stockcode	Intended for	Qty/pack	Striker Ø	Fits to
827547 HEADS F. RECOILLESS H. SF 30 NYLON	823312	1 pcs	30 mm	823312
827549 HEADS F. RECOILLESS H. SF 40 NYLON	823314	1 pcs	40 mm	823314
827551 HEADS F. RECOILLESS H. SF 50 NYLON	823315	1 pcs	50 mm	823315
827552 HEADS F. RECOILLESS H. SF 60 NYLON	823316	1 pcs	60 mm	823316

---







# Sledges to rely on.

MADE TO HANDLE TOUGH CONDITIONS.

Hultafors sledge range includes sledges for wood, stone/rock and metal. Choosing the right sledge with the right head will make your work both safer and more efficient. All our sledge heads are made from high grade steel, correctly tempered in order to achieve the best possible level of strength and durability, which in turn increases user safety.

## SLEDGE STS, FIBREGLASS

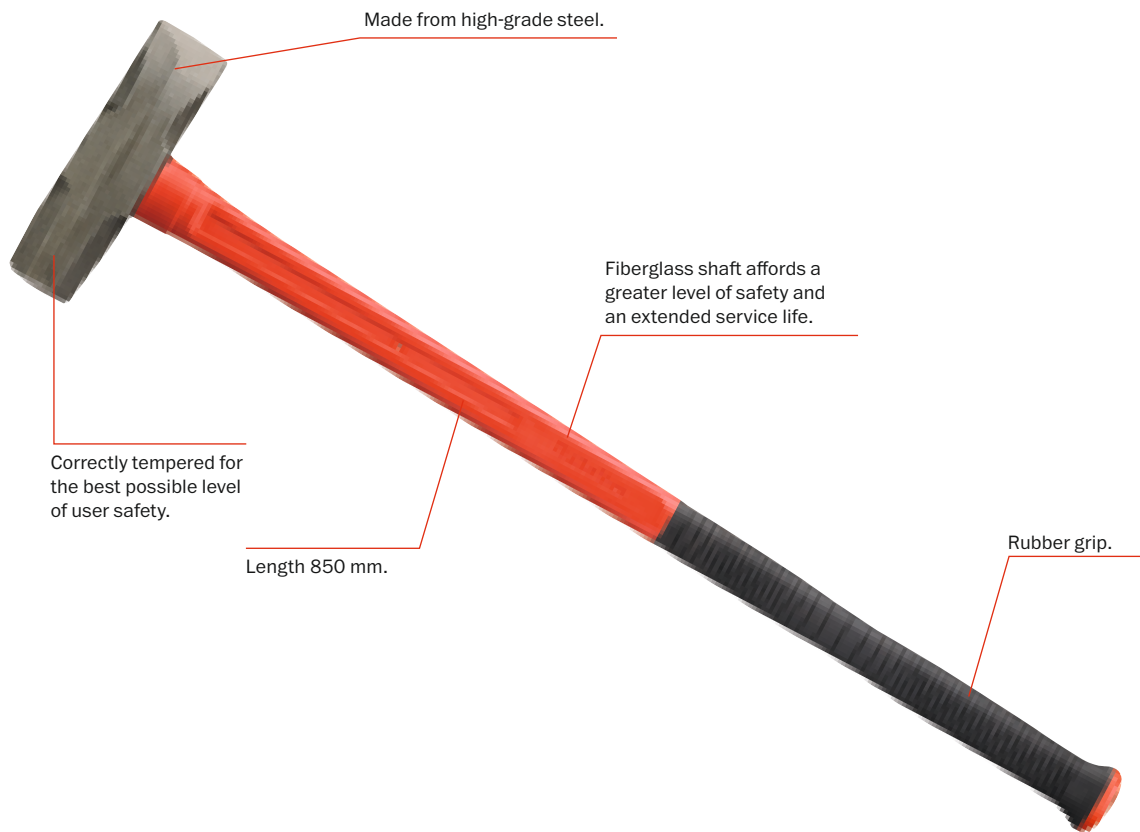

## Safety first.

HOW TO USE A SLEDGE IN A SAFE WAY.

To ensure safe usage it is important that sledges are used in the right way. Most important of all is to never strike a sledge against another piece of tempered steel. If a splinter were to come off as the result of such a strike, it may have the same effect as if a bullet had been fired from a small calibre gun. To protect your vision, you should always wear protective goggles whenever you use your sledge. Also remember not to store your sledge near any heat sources as there is a risk that the wood may shrink, causing the head to loosen from the handle.

## Long-lasting materials.

CHOOSE BETWEEN WOOD OR FIBREGLASS.

All Hultafors sledges are made to last. Our shafts are made from either fiberglass or wood.

The shafts made of fiberglass are ergonomically shaped and covered with rubber, offering a greater level of safety and an extended service life. The wooden shafts are made of hickory – a strong and flexible wood, and are available as a spare. That means that as long as the head is in good condition you can replace the shaft when the old one is worn out, extending the life span of the sledge.

## Sledge Double-faced KS

Sledge made from blasted and clear-lacquered ironwork, with tempered square striking faces at both ends. The shaft is 900 mm long and is made from hickory.

- Made from high-grade steel, correctly tempered for the best possible level of user safety.
- The wooden shaft is available as a spare.
- NOTE! Always wear protective goggles!



Stockcode	Qty/pack	Weight	Handle	Handle length
825001 DOUBLE FACE SLEDGE KS 4000	1 pcs	4000 g	Hickory	900 mm
825002 DOUBLE FACE SLEDGE KS 5000	1 pcs	5000 g	Hickory	900 mm
825003 DOUBLE FACE SLEDGE KS 6000	1 pcs	6000 g	Hickory	900 mm

## Sledge Double-faced KS, Fibreglass

Sledge made from blasted and clear-lacquered ironwork, with tempered square striking faces at both ends. Has an 850 mm long fibreglass shaft with a rubber grip.

- Made from high-grade steel, correctly tempered for the best possible level of user safety.
- Fibreglass shaft affords a greater level of safety and an extended service life.
- NOTE! Always wear protective goggles!



Stockcode	Qty/pack	Weight	Handle	Handle length
825041 DOUBLE FACE SLEDGE GF KS 4000 G	1 pcs	4000 g	G	850 mm
825042 DOUBLE FACE SLEDGE GF KS 5000 G	1 pcs	5000 g	G	850 mm
825043 DOUBLE FACE SLEDGE GF KS 6000 G	1 pcs	6000 g	G	850 mm

## Sledgehammer Double-faced MH

Sledgehammer made from black painted ironwork, with tempered square striking faces at both ends. Hickory shaft.

- Made from high-grade steel, correctly tempered for the best possible level of user safety.
- The wooden shaft is available as a spare.
- NOTE! Always wear protective goggles!



Stockcode	Qty/pack	Weight	Handle	Handle length
843303 DOUBLE FACE SLEDGE MH 3000	1 pcs	3000 g	Hickory	750 mm
843304 DOUBLE FACE SLEDGE MH 4000	1 pcs	4000 g	Hickory	750 mm
843305 DOUBLE FACE SLEDGE MH 5000	1 pcs	5000 g	Hickory	800 mm
843306 DOUBLE FACE SLEDGE MH 6000	1 pcs	6000 g	Hickory	800 mm

## Sledge Double-faced HHK

Sledgehammer with black painted ironwork, tempered hexagon striking face on both sides. Wooden handle.

- NOTE! Always wear protective goggles!



Stockcode	Qty/pack	Weight	Total weight	Handle	Handle length
867001 BLACKSMITHS SLEDGE HOBBY HHK 4	1 pcs	4000 g	4000 g	Hickory	750 mm

## Sledge STS

Stone sledge made from blasted and clear-lacquered ironwork, with a tempered square striking face at one end and a straight pein at the other. The shaft is 900 mm long and is made from hickory.

- Made from high-grade steel, correctly tempered for the best possible level of user safety.
- The wooden shaft is available as a spare.
- NOTE! Always wear protective goggles!



Stockcode	Qty/pack	Weight	Handle	Handle length
825010 STONE SLEDGE STS 3000	1 pcs	3000 g	Hickory	900 mm
825011 STONE SLEDGE STS 4000	1 pcs	4000 g	Hickory	900 mm
825012 STONE SLEDGE STS 5000	1 pcs	5000 g	Hickory	900 mm

## Sledge STS, Fibreglass

Sledge made from blasted and clear-lacquered ironwork, with tempered square striking faces at one end and a straight pein at the other. Has an 850 mm long fibreglass shaft with a rubber grip.

- Made from high-grade steel, correctly tempered for the best possible level of user safety.
- Fibreglass shaft affords a greater level of safety and an extended service life.
- NOTE! Always wear protective goggles!



Stockcode	Qty/pack	Weight	Handle	Handle length
825050 STONE SLEDGE GF-HANDLE STS 3000 G	1 pcs	3000 g	G	850 mm
825051 STONE SLEDGE GF-HANDLE STS 4000 G	1 pcs	4000 g	G	850 mm
825052 STONE SLEDGE GF-HANDLE STS 5000 G	1 pcs	5000 g	G	850 mm

## Copper Hammer CU



Hammer with copper head and fibreglass shaft. Copper hammers are spark-free and gentle on workpieces.

- Soft copper head is gentle on workpieces.
- For work in spark-free environments.
- Fibreglass shaft affords a greater level of safety and an extended service life.

Stockcode	Qty/pack	Total weight	Handle	Handle length
823031 COPPER HAMMER CU 300	2 pcs	400 g	G	260 mm
823032 COPPER HAMMER CU 1000	2 pcs	1300 g	G	340 mm
823034 COPPER HAMMER CU 2000	2 pcs	2400 g	G	340 mm

## Copper Sledge CU



Sledge with copper head and fibreglass shaft. These sledges are spark-free and gentle on workpieces.

- Soft copper head is gentle on workpieces.
- For work in spark-free environments.
- Fibreglass shaft affords a greater level of safety and an extended service life.

Stockcode	Qty/pack	Weight	Handle	Handle length
823035 COPPER HAMMER CU 3000	1 pcs	3000 g	G	850 mm
823036 COPPER HAMMER CU 4000	1 pcs	4000 g	G	850 mm
823037 COPPER HAMMER CU 5000	1 pcs	5000 g	G	850 mm



## Dead Blow Hammer DB



Hammer head covered with Urethane and a dead blow function using steel balls to cushion the shock and reduce recoil. Soft faces that is gentle on the work piece and non-sparking due to no exposed metal. Ergonomic handle in fibreglass with grip in Santoprene rubber.

- Soft face, doesn't damage surfaces or equipment.
- Dead blow function uses steel balls to cushion the shock and reduce recoil.
- Ergonomic handle in fibreglass with grip in Santoprene.
- Non-sparking, no exposed metal.
- Flat area on head allows upright storage.

Stockcode	Width	Length	Height	Qty/pack	Total weight	Handle	Handle length	Ø
823411 DEAD BLOW HAMMER DB 600	96 mm	295 mm	50 mm	2 pcs	570 g	Rubber grip	240 mm	43 mm
823412 DEAD BLOW HAMMER DB 1200	128 mm	353 mm	64 mm	2 pcs	1160 g	Rubber grip	282 mm	50 mm
823413 DEAD BLOW HAMMER DB 1600	150 mm	424 mm	74 mm	1 pcs	1650 g	Rubber grip	342 mm	60 mm
823414 DEAD BLOW HAMMER DB 5000	232 mm	975 mm	104 mm	1 pcs	5700 g	Rubber grip	838 mm	88 mm



## Hammer shaft



Stockcode	Wedge	Qty/pack	Handle	Fits to
827001 SPARE HANDLES HS 290-12x9	-	5 pcs	Hickory	AB 150. XK 150.
827002 SPARE HANDLES HS 310-15x10	-	5 pcs	Hickory	AB 200, 300. XK 200, 300. GMH 150.
827004 SPARE HANDLES HS 330-17x11	SK 9	5 pcs	Hickory	AB 400, 600. XK 400, 500.
827206 SPARE HANDLES HS 375-21x14	SK 11	5 pcs	Hickory	Z 800, 900, 1000.
827208 SPARE HANDLES HS 410-25x18	SK 12	5 pcs	Hickory	Z 1200, 1500, 2000.
827222 SPARE HANDLES MHS 305-22x17	SK 12	5 pcs	Hickory	ME 1000, 1200, 1500.
827231 SPARE HANDLES LHS 350-22x12	SK 12	5 pcs	Hickory	KP 650, 750.
827085 SPARE HANDLE BHS 280-20x12	SK 9	5 pcs	Hickory	B 200.
827086 SPARE HANDLE BHS 300-22x13	SK 9	5 pcs	Hickory	B 300, 400.
827261 SPARE HANDLES MHS 270-D24	SK 12	5 pcs	Hickory	M 500, 600.
827070 SPARE HANDLE BHS 295-19x11	SK 9	5 pcs	Hickory	SH 200.
827071 SPARE HANDLE BHS 315-22x13	SK 9	5 pcs	Hickory	SH 250, 400.
842073 SPARE HANDLES SHS 380-32x19	SK 12	5 pcs	Hickory	SMH 1000, 1500.
842074 SPARE HANDLES SHS 400-36x21	SK 12	5 pcs	Hickory	SMH 2000.
842064 SPARE HANDLES BHS 350-33x23	SK 12	5 pcs	Hickory	Universal handle
842091 SPARE HANDLE MHS 280-31x21	SK 12	5 pcs	Hickory	MH 1000, 1250, 1500.
842092 SPARE HANDLE MHS 300-37x21	SK 12	5 pcs	Hickory	MH 2000.

## Sledge shaft straight with Steel Wedge



Stockcode	Wedge	Qty/pack	Handle	Handle length	Fits to
842050 SPARE HANDLES SSR 900-41x32	SK 16	5 pcs	Hickory	900 mm 36"	825001, 825002, 825003, 825010, 825011, 825012
842080 SPARE HANDLES SSR 750-42x24	SK 16	5 pcs	Hickory	750 mm/30"	843204, 843103, 843104, 843303, 843304
842053 SPARE HANDLES SSR 900-45x35	-, SK 16	5 pcs	Hickory	900 mm 36"	Universal handle
842081 SPARE HANDLES SSR 800-47x27	SK 17	5 pcs	Hickory	800 mm 32"	843105, 843106, 843305, 843306
842054 SPARE HANDLES SSR 900-50x36	SK 17	5 pcs	Hickory	900 mm 36"	Universal handle



Hultafors



# Forged with tradition.

AXES THAT LAST FOR GENERATIONS.

Our range of axes include both models used for traditional woodwork as well as outdoor models for the enthusiasts. What they have in common is their history. Hultafors axes have been crafted in the traditional way since 1697, being hand forged at Hults Bruk in Östergötland, Sweden. This handcraft in combination with the forging art results in a reliable high density product with a long service life that can be used for several generations. That is why we provide a lifetime warranty for all our Premium axes.

## STÅLBERG CARPENTER AXE

Made from carefully selected American hickory and treated with linseed oil.

Named after one of the most experienced smiths at Hults Bruk; Ernst Ståhlberg.

A notch near the shaft allows you to hold a hand directly above the edge while cutting.

As long as the head is in good condition you can re-use your tool by fitting a new shaft when the old one is worn out.

The steel is struck 40-60 times increasing the density and durability of the head.

Made from Swedish recycled steel.

Scandinavian grind which is easy to sharpen due to the large surface.

Each head is unique as all our axes are forged by hand

## Welcome to the outdoors.

BRINGING HISTORY INTO THE FUTURE.

At Hults Bruk in Östergötland, Sweden, there are smiths who carry out work that not many others are able to do. In fact, there are very few producers in the world employing smiths with the skills this craft requires. With our Premium range we are bringing over 300 years of craftsmanship into the future. To celebrate our history, the products have been named after a famous blacksmith or a local area around the forge.

## Lifetime warranty.

ALL OUR PREMIUM AXES COME WITH A LIFETIME WARRANTY.

We have a long tradition of axe manufacturing. In fact our craft has been practiced for over 300 years and the head-forging process has been refined for as many years. That is why we include a lifetime warranty with each Premium axe head. The certificate has to be registered online and is valid during 50 years, from the date of purchase.

LEARN MORE ABOUT  
AXE CARE AT PAGE 198



## Hultån Hatchet

Our classic trekking hatchet is the perfect outdoor companion, whether you are hiking in the wild or just need to work on the camp fire. The hatchet comes in handy for almost any task in the forest, but first and foremost for camp site work, such as collecting and processing fire wood and building shelter. Because of its versatility and light weight, Hultån has become a best seller. The hatchet is hand forged and made from Swedish quality steel in the forge at Hults Bruk. The forging tradition goes as far back as 1697, and the steel head is struck 40-60 times to increase density and durability to the head. The hatchet is named after Hultån, the stream where the water for the water wheels was once taken. Take care of your hatchet and it will stay a faithful companion for many years to come. Thanks to the quality and craftsmanship of this axe, we offer you a full lifetime warranty on the axe head.

- Wooden handle from American hickory, treated with linseed oil
- Convex grind edge
- The edge is sharpened, polished and ready to use
- Leather axe sheath included

Stockcode	Head weight	Qty/pack	Total weight	Handle	Handle length
841701 HATCHET HB HULTÅN 0,5	500 g	1 pcs	805 g	Hickory	375 mm/15"



## Ågelsjön Mini Hatchet

This is our smallest hatchet, suitable for hiking in the mountains or in the woods. The hatchet is flexible and easy to use, and it fits perfectly for diverse tasks near the camp site, such as processing fire wood and shelter building. With its short handle and light weight, it is easy to pack in your back pack or attach to your belt. This hatchet has become a favourite among those who enjoy spending time around the camp fire. The hatchet is hand forged and made from Swedish quality steel in the forge at Hults Bruk. The forging tradition goes as far back as 1697, and the steel head is struck 40-60 times to increase density and durability to the head. The axe is named after the nearby lake Ågelsjön, where the water needed to run the waterwheel for the forge was once taken. Take care of your hatchet and it will stay a faithful companion for many years to come. Thanks to the quality and craftsmanship of this axe, we offer you a full lifetime warranty on the axe head.

- Wooden handle from American hickory, treated with linseed oil
- Convex grind edge
- The edge is sharpened, polished and ready to use
- Leather axe sheath included

Stockcode	Head weight	Qty/pack	Total weight	Handle	Handle length
841760 HATCHET MINI HB ÅGELSJÖN 0,5	500 g	1 pcs	775 g	Hickory	235 mm/9"



## Ekelund Hunting Axe

With its ground neck and medium-weight head, our classic hunting is ideal for easier forestry work as well as for skinning game with great precision. This makes it your perfect hunting partner. It is also an ideal gift for any hunting enthusiast. The axe is hand forged and made from Swedish quality steel in the forge at Hults Bruk. The forging tradition goes as far back as 1697, and the steel head is struck 40-60 times to increase density and durability to the head. The name of this axe comes from Gunnar Ekelund, the squire who initiated axe production at a larger scale in Hults Bruk in 1870 - 1875. Take care of your axe and it will stay a faithful companion for many years to come. Thanks to the quality and craftsmanship of this axe, we offer you a full lifetime warranty on the axe head.

- Wooden handle from American hickory, treated with linseed oil
- Convex grind edge
- The edge is sharpened, polished and ready to use
- Leather axe sheath included

Stockcode	Head weight	Qty/pack	Total weight	Handle	Handle length
841710 HUNTING AXE HB EKELUND 0,85	850 g	1 pcs	1210 g	Hickory	500 mm/20"





## Qvarfot Felling Axe

This is an axe well suited to assist you in small scale forestry. The long shaft adds force to the striking action and the axe is also useful for splitting, bucking and processing wood. The axe is hand forged and made from Swedish quality steel in the forge at Hults Bruk. The forging tradition goes as far back as 1697, and the steel head is struck 40-60 times to increase density and durability to the head. This axe is named after one of the families who served as blacksmiths at Hults Bruk for generations, the Qvarfot's. Take care of your axe and it will stay a faithful companion for many years to come. Thanks to the quality and craftsmanship of this axe, we offer you a full lifetime warranty on the axe head.

- Wooden handle from American hickory, treated with linseed oil
- Convex grind edge
- The edge is sharpened, polished and ready to use
- Leather axe sheath included

Stockcode	Head weight	Qty/pack	Total weight	Handle	Handle length
841720 FELLING AXE HB QVARFOT 0,85	850 g	1 pcs	1260 g	Hickory	650 mm/26"



## Stålberg Carpenter Axe

With its straight handle and long, narrow and straight edge, our carpenter axe provides you with the precision any skilled craftsman demands. The finger notch in the axe head allows a grip where your hand is placed, almost straight above the center of the cutting edge, for increased precision. The axe is hand forged and made from Swedish quality steel in the forge at Hults Bruk. The forging tradition goes as far back as 1697, and the steel head is struck 40-60 times to increase density and durability to the head. This axe is named after one of Hults Bruk's most experienced blacksmiths from the first half of the 20th century, Ernst Stålberg. Take care of your axe and it will stay a faithful companion for many years to come. Thanks to the quality and craftsmanship of this axe, we offer you a full lifetime warranty on the axe head.

- Wooden handle from American hickory, treated with linseed oil
- Straighter edge with Scandinavian grind
- The edge is sharpened, polished and ready to use
- Leather axe sheath included

Stockcode	Head weight	Qty/pack	Total weight	Handle	Handle length
841730 CARPENTERS AXE HB STÅLBERG 0,8	850 g	1 pcs	1225 g	Hickory	500 mm/20"



## Wetterhall Throwing Axe

This kind of double bit axe was originally used by lumberjacks, who benefitted from the possibility of always having a sharp axe around. While using one edge for rough work, they could be more careful with the other. Today it is primarily employed in throwing competitions among enthusiasts. The axe is hand forged and made from Swedish quality steel in the forge at Hults Bruk. The forging tradition goes as far back as 1697, and the steel head is struck 40-60 times to increase density and durability to the head. This axe has been named after Bo Wetterhall, the man who served longer than anyone at Hults Bruk. Take care of your axe and it will stay a faithful companion for many years to come. Thanks to the quality and craftsmanship of this axe, we offer you a full lifetime warranty on the axe head.

- Wooden handle from American hickory, treated with linseed oil
- The edge is sharpened, polished and ready to use
- Leather axe sheath included

Stockcode	Head weight	Qty/pack	Total weight	Handle	Handle length
841750 THROWING AXE HB WETTERHALL 1,6	1600 g	1 pcs	2280 g	Hickory	760 mm/30"



## Hult Splitting Axe

This is a solid splitting axe, intended for heavier duties such as splitting logs and wood. The shape of the head, in combination slightly convex grinding, splits the wood. The axe has a long and straight handle made from American hickory, to gain maximal speed and control when splitting logs. The axe is hand forged and made from Swedish quality steel in the forge at Hults Bruk. The forging tradition goes as far back as 1697, and the steel head is struck 40-60 times to increase density and durability to the head. The name of this axe has its origin in Hult, the area where Hults Bruk was founded. Like most old Swedish geographical names, it describes the surrounding landscape of the place. Take care of your axe and it will stay a faithful companion for many years to come. Thanks to the quality and craftsmanship of this axe, we offer you a full lifetime warranty on the axe head.

- Wooden handle from American hickory, treated with linseed oil
- Slightly convex grinding
- The edge is sharpened, polished and ready to use
- Leather axe sheath included

Stockcode	Head weight	Qty/pack	Total weight	Handle	Handle length
841740 SPLITTING AXE HB HULT 1,5	1500 g	1 pcs	2020 g	Hickory	750 mm/30"



## Åby Forest Axe

Our forest axe is a beautiful hybrid with many types of use. Åby has a straighter edge and grinding, and a good finger notch below the head for increased precision. The long, thin ergonomic handle minimizes the weight, at the same time giving you great force when striking. This axe is perfect for shelter building, processing firewood, and carving as well as precision work. In short, it is your perfect forest companion. The axe is hand forged and made from Swedish quality steel in the forge at Hults Bruk. The forging tradition goes as far back as 1697, and the steel head is struck 40-60 times to increase density and durability to the head. This axe is named after Åby, the nearest village to Hults Bruk, where many of the workers lived in the middle of the 20th century. Take care of your axe and it will stay a faithful companion for many years to come. Thanks to the quality and craftsmanship of this axe, we offer you a full lifetime warranty on the axe head.

- Wooden handle from American hickory, treated with linseed oil
- Straighter edge with Scandinavian grind
- The edge is sharpened, polished and ready to use
- Leather axe sheath included

Stockcode	Head weight	Qty/pack	Total weight	Handle	Handle length
841770 FOREST AXE HB ÅBY 0,7	700 g	1 pcs	1015 g	Hickory	600 mm/24"

## Grinding stone



With our grinding stone you can easily and securely grind your axe wherever you are. The grinding stone is of good size and designed to give a steady grip, protecting fingers and hands from cutting injuries. The elegant case in genuine leather protects your grinding stone, rendering it a long life. The rough side has a grain size of 180, and the fine side a grain size of 600. This is a good combination to regain sharpness to your axe. To make your work easier, we would recommend you to grind with water.

- Perfect for axes
- Coarse grit 180
- Fine grit 600
- 75mm diameter
- Total weight: 220 g

Stockcode	Width	Qty/pack
840792 GRINDING STONE AXE GS 600/180	25 mm	1 pcs



## Trekkers Little Helper "Forsberg"

The Forsberg is a versatile and useful companion for anyone who appreciates being in the wild. It is the perfect protection for your thigh and knee when working with knife or axe close to your body. It can also be used as a protected place to start a fire, then easily move the fire to the fireplace. The impregnated leather also makes it a perfect seat pad. With Trekker's Little Helper you get multiple functions in one, all depending on your needs. The Forsberg is the perfect gift for big and small bushmen!

- Genuine leather
- Impregnated on both sides, and perfect as a seat pad
- Perfect to help you start and move a fire
- Protects yourself when carving and processing wood
- Holes and leather strap for easier fastening onto your backpack etc.

Stockcode	Width	Length	Qty/pack
840791 TREKKERS LITTLE HELPER FORSBERG 32x22	220 mm	320 mm	1 pcs

## Spare Sheath Premium



Stockcode	Qty/pack	Fits to
840746 SPARE SHEATH HB SSHB-1,5S	1 pcs	841740
840756 SPARE SHEATH HB SSHB-1,6T	1 pcs	841750
840736 SPARE SHEATH HB SSHB-0,8C	1 pcs	841730
840716 SPARE SHEATH HB SSHB-0,85HF	1 pcs	841710, 841720
840776 SPARE SHEATH HB SSHB-0,7F	1 pcs	841770

## Hatchet



A small axe for outdoor use in forests and open land. Made from blasted and clear-lacquered ironwork, it is also suitable for work in the garden. The shaft is curved and made from hickory. Leather axe sheath is included

- The axe is hand-forged and made from Swedish axe steel using traditional methods in use since 1697.
- The steel is stuck several times, increasing its density and thereby the durability of the axe.
- Has a clear tempered zone within which the axe can be sharpened whilst not detracting from the strength of the edge.
- The shaft is made from hickory and treated with linseed oil.
- Leather axe sheath included.

Stockcode	Head weight	Qty/pack	Handle	Handle length
840025 HATCHET H 006 SV	600 g	4 pcs	Hickory	375 mm/15"
840066 HATCHET H 008 SV	800 g	4 pcs	Hickory	440 mm/17,5"
840086 HATCHET H 009 SV	900 g	4 pcs	Hickory	500 mm/20"

## Spare Sheath



Stockcode	Qty/pack	Fits to
840640 SPARE SHEATH EG 95	1 pcs	840066, 840086
840642 SPARE SHEATH EG 80	1 pcs	840025

## Carpenter's Axe SY RA



Blasted and clear-lacquered ironwork with a notch in the head near the shaft, allowing you to hold a hand directly above the edge while cutting. The shaft is straight and made from hickory.

- The axe is hand-forged and made from Swedish axe steel using traditional methods in use since 1697.
- The steel is stuck several times, increasing its density and thereby the durability of the axe.
- Has a clear tempered zone within which the axe can be sharpened whilst not detracting from the strength of the edge.
- The shaft is made from hickory and treated with linseed oil.

Stockcode	Head weight	Qty/pack	Handle	Handle length
840303 CARPENTER'S AXE SY 21-0,8 RA	800 g	4 pcs	Hickory	500 mm/20"
840325 CARPENTER'S AXE SY 21-1,0 RA	1000 g	4 pcs	Hickory	500 mm/20"

## Carpenter's Axe SY SV



Blasted and clear-lacquered ironwork with a notch in the head near the shaft, allowing you to hold a hand directly above the edge while cutting. The shaft is curved and made from hickory.

- The axe is hand-forged and made from Swedish axe steel using traditional methods in use since 1697.
- The steel is stuck several times, increasing its density and thereby the durability of the axe.
- Has a clear tempered zone within which the axe can be sharpened whilst not detracting from the strength of the edge.
- The shaft is made from hickory and treated with linseed oil.

Stockcode	Head weight	Qty/pack	Handle	Handle length
840304 CARPENTER'S AXE SY 21-0,8 SV	800 g	4 pcs	Hickory	500 mm/20"
840326 CARPENTER'S AXE SY 21-1,0 SV	1000 g	4 pcs	Hickory	500 mm/20"



## Felling Axe HY 10

An axe suitable for small-scale felling, made from blasted and clear-lacquered ironwork. The shaft is curved and made from hickory.



- The axe is hand-forged and made from Swedish axe steel using traditional methods in use since 1697.
- The steel is stuck several times, increasing its density and thereby the durability of the axe.
- Has a clear tempered zone within which the axe can be sharpened whilst not detracting from the strength of the edge.
- The shaft is made from hickory and treated with linseed oil.

Stockcode	Head weight	Qty/pack	Handle	Handle length
840063 FELLING AXE HY 10-0,8 SV	800 g	4 pcs	Hickory	650 mm/26"
840085 FELLING AXE HY 10-0,9 SV	900 g	4 pcs	Hickory	650 mm/26"
840108 FELLING AXE HY 10-1,0 SV	1000 g	4 pcs	Hickory	700 mm/28"
840144 FELLING AXE HY 10-1,2 SV	1200 g	4 pcs	Hickory	700 mm/28"
840185 FELLING AXE HY 10-1,5 SV	1500 g	4 pcs	Hickory	800 mm 32"

## Felling Axe HY 20

An axe suitable for small-scale felling, made from blasted and clear-lacquered ironwork. The shaft is curved and made from hickory. Particularly suitable for lopping branches or clearing bushes and brushwood.



- The axe is hand-forged and made from Swedish axe steel using traditional methods in use since 1697.
- The steel is stuck several times, increasing its density and thereby the durability of the axe.
- Has a clear tempered zone within which the axe can be sharpened whilst not detracting from the strength of the edge.
- The shaft is made from hickory and treated with linseed oil.

Stockcode	Head weight	Qty/pack	Handle	Handle length
840281 HULTAFORS FELLING AXE HY 20-0,85 SV	850 g	4 pcs	Hickory	650 mm/26"

## Arvika 5 Star

Large felling axe designed for competition and serious chopping. The design of the head is inspired by Australian Racing Pattern Axes, polished and heavy with a convex grind edge. The long and curved handle in American hickory provides maximum speed and force when felling trees. The axe is hand forged and made from Swedish quality steel in the forge at Hults Bruk. Our forging tradition goes as far back as 1697, and the steel head is struck over 60 times to increase density and durability to the head. Take care of your axe and it will stay a faithful companion for many years to come.



- Total weight: 2750 g / 6 lbs
- Weight of head: 2000 g / 4 ½ lbs
- Length of handle: 800 mm / 32"
- The edge needs to be fine sharpened before use
- Wooden handle from American hickory, treated with linseed oil

Stockcode	Head weight	Qty/pack	Total weight	Handle	Handle length
840511 AXE ARVIKA 5 STAR 8F-2,0 800/32"	2000 g	4 pcs	2750 g	Hickory	800 mm 32"

## Splitting Axe KLY SV

Splitting axe made from blasted and clear-lacquered ironwork. The heavier axe is best suited to stronger wood, while the lighter axe is best suited to basic splitting of 'fireplace wood'. The shaft is curved and made from hickory.



- The axe is hand-forged and made from Swedish axe steel using traditional methods in use since 1697.
- The steel is stuck several times, increasing its density and thereby the durability of the axe.
- Has a clear tempered zone within which the axe can be sharpened whilst not detracting from the strength of the edge.
- The shaft is made from hickory and treated with linseed oil.

Stockcode	Head weight	Qty/pack	Weight	Handle	Handle length
840581 SPLITTING AXE KLY 7-0,9 SV	900 g	4 pcs	900 g	Hickory	500 mm/20"
840593 SPLITTING AXE KLY 7-1,5 SV	1500 g	2 pcs	1500 g	Hickory	750 mm/30"

## Splitting Axe KLY RA

Splitting axe made from blasted and clear-lacquered ironwork. Heavier axe ideally suited for splitting heavy wood. The shaft is straight and made from hickory.



- The axe is hand-forged and made from Swedish axe steel using traditional methods in use since 1697.
- The steel is stuck several times, increasing its density and thereby the durability of the axe.
- Has a clear tempered zone within which the axe can be sharpened whilst not detracting from the strength of the edge.
- The shaft is made from hickory and treated with linseed oil.

Stockcode	Head weight	Qty/pack	Handle	Handle length
840592 SPLITTING AXE KLY 7-1,5 RA	1500 g	2 pcs	Hickory	750 mm/30"

## Splitting Axe SLY

Our most powerful and heaviest splitting axe, made from blasted and clear-lacquered ironwork. Has a tempered striking face at the back of its head and can therefore also be used as a sledge. NOTE: never strike the tempered striking face against other tempered objects. The shaft is straight and made from hickory.



- Has a tempered striking face at the back of its head and can therefore also be used as a sledge.
- The axe is hand-forged and made from Swedish axe steel using traditional methods in use since 1697.
- The steel is stuck several times, increasing its density and thereby the durability of the axe.
- Has a clear tempered zone within which the axe can be sharpened whilst not detracting from the strength of the edge.
- The shaft is made from hickory and treated with linseed oil.

Stockcode	Head weight	Qty/pack	Handle	Handle length
840601 SPLITTING AXE SLY 141-2,5 RA	2500 g	2 pcs	Hickory	800 mm 32"



## Wedge

A complementary tool for splitting axes that makes it easier to split particularly thick pieces of wood. Use the tempered striking surface at the back of the sledge axe or a tempered steel sledge when working using a wedge.

- Not tempered, allowing you to use tempered tools in conjunction with the wedge.

Stockcode	Qty/pack	Weight
840620 WEDGE VK 1200 RA	2 pcs	1200 g



## Steel Wedge Round, 2-pack.

Stockcode	Length	Qty/pack	Ø	Fits to
828600 9 MM RING WEDGES 2-PCS SK 9 SB	14.5 mm	10 pcs	9 mm	AB 400, 600. XK 400, 500. SH 200.
828601 11 MM RING WEDGES 2-PCS SK 11 SB	16.5 mm	10 pcs	11 mm	Z 800, 900, 1000. MH 1000.
828602 12 MM RING WEDGES 2-PCS SK 12 SB	17.5 mm	10 pcs	12 mm	Z 1200, 2000. B 600, 800. ME 1000, 1200, 1500. M 600. KP 650, 750.
828603 16 MM RING WEDGES 2-PCS SK 16 SB	22 mm	10 pcs	16 mm	KS 3000, 4000, 5000. STS 3000, 4000, 5000. Z 1500, SMH 3000. MH 3000. Axe 0,6kg-1,2kg.
828604 17 MM RING WEDGES 2-PCS SK 17 SB	23 mm	10 pcs	17 mm	SMH 4000, 5000, 6000. MH 4000, 5000, 6000. Axe 1,5kg-2,5kg.



## Axe handle Premium Curved

Spare handle curved shape, made from american hickory, treated with linseed oil. Increase the life span for your axe by changing the handle when needed.

- Wooden handle from American hickory, treated with linseed oil

Stockcode	Wedge	Qty/pack	Handle	Handle length	Fits to
842701 HANDLE HB AHC 375-43X18 HB	SK 12	1 pcs	Hickory	414 mm/16"	841701
842710 HANDLE HB AHC 500-50x20 HB	SK 16	1 pcs	Hickory	558 mm/22"	840066, 840086, 840581, 840304, 840326, 840710
842720 HANDLE HB AHC 650-50x20 HB	SK 16	1 pcs	Hickory	690 mm/27"	841720
842760 HANDLE HB AHC 235-43X18 HB	SK 12	1 pcs	Hickory	280 mm/11"	841760
842770 HANDLE HB AHC 600-43X18 HB	SK 12	1 pcs	Hickory	630 mm/25"	841770



### Axe Handle Straight

Spare handle straight shape, made from american hickory, treated with linseed oil. Increase the life span for your axe by changing the handle when needed.

- Wooden handle from American hickory, treated with linseed oil

Stockcode	Wedge	Qty/pack	Handle	Handle length	Fits to
842730 HANDLE HB AHS 500-50x20 HB	SK 16	1 pcs	Hickory	533 mm/21"	841730
842750 HANDLE HB AHS 760-60X17 HB	SK 17	1 pcs	Hickory	790 mm/31"	841750
842740 HANDLE HB AHS 750-63X23 HB	SK 17	1 pcs	Hickory	780 mm/31"	841740

### Axe shaft Curved with wooden wedge



Stockcode	Wedge	Qty/pack	Handle	Handle length	Fits to
842000 SPARE HANDLE YSS 375-50x20	SK 16	5 pcs	Hickory	375 mm/15"	840025
842008 SPARE HANDLE YSS 700-50x20	SK 16	5 pcs	Hickory	700 mm/28"	840063, 840085, 840108, 840144
842010 SPARE HANDLE YSS 750-63x23	SK 17	5 pcs	Hickory	750 mm/30"	840581, 840593, 840185
842012 HANDLE ARVIKA YSS 800 63X23	SK 17	5 pcs	Hickory	800 mm 32"	840511

### Axe Shaft Straight With Wooden Wedge



Stockcode	Wedge	Qty/pack	Handle	Handle length	Qty	Fits to
842009 SPARE HANDLE YSR 750-63x23	SK 17	5 pcs	Hickory	750 mm/30"	1 pcs	KLY 7-1,5. HB KLY-1,5.
842011 SPARE HANDLE YSR 800-55x27	SK 17	5 pcs	Hickory	800 mm 32"	2 pcs	SLY 141-2,5.



## Shaft Straight



---

Stockcode	Wedge	Qty/pack	Handle	Handle length
842042 SPARE HANDLE KS 900-72x40	-	5 pcs	Birch	900 mm 36"
842062 SPARE HANDLES HS 900-75x53	-	5 pcs	Birch	900 mm 36"

---



# The sharpest choice.

## SHARP KNIVES FOR VARYING TASKS.

The most important characteristic of the knife is a sharp blade. Our complete range of snap-off knives offers excellent sharpness and precision in the cut, again and again, without interruption. In this way, the work is done efficiently without the tool taking focus from the task. The snap-off knife is the perfect choice for jobs that require extra sharpness, such as cutting into cardboard, wallpaper or carpets.

### SNAP-OFF KNIFE

SFRPB 18A/W – ergonomic snap-off knives with tail fins.

SFRPB 18A

Curved tail fin that efficiently tucks carpet edges or opens cans.

Available with wheel lock or auto lock function.

SFRPB 18W

The knife has room for a magazine with 3 extra blades.

1 mm thick metal blade rail for additional stability.

Steel core for added stability.

Rubberised grip makes it suitable for materials that require more power when cutting.

Used for cutting plasterboard, insulation, wet room boards and wood.

Tapered for better visibility, access and control.

### Selection of blades.

#### PRECISION OR FLEXIBILITY.

In order to meet the craftsman's requirements for perfect cuts, we have produced four different blade qualities. They are adapted for different tasks without sacrificing precision, sharpness and longevity. All-round is a versatile blade with good longevity and Edge is the blade for those who want really nice cuts. If you cut a lot and want extra long life in the blade, Performance is the best choice. Non-segment is the blade that is flexible and bendable without the risk of being broken. All sections of the blade can be used on our snap-off knives, including the last one.

### Slim design or rubberised grip.

#### IT DEPENDS ON THE TASK.

All snap-off knives except SPP 9A are available in two different variants, compact slim design or with rubberised grip. The narrower one takes up less space in the pocket without compromising ergonomics or precision. Rubberised grips are good when more force needs to be applied to the cut, for example when cutting carpets and plasterboard. These knives also have a magazine for three extra blades. All except SPP 9A are available with auto lock or wheel lock function.



### Snap-off knife SFRPB 18A



Ergonomic snap-off knife with a bent tail fin. The knife is suitable for all-round use such as cutting plasterboard, insulation, aqua panel and wood. The design with rubberised grip makes it suitable for materials demanding more power. Tapered knife tip with extended front of blade rail for better stability, access and visibility. The bent tail fin efficiently tucks carpets or opens cans. The knife can hold a dispenser with 3 spare blades and is made of durable PC-plastic (polycarbonate) with a steel core for added stability. 1 mm thick metal blade rail for additional stability.

- Used for cutting plasterboard, insulation, aqua panel and wood
- Auto lock function
- Made of durable PC-plastic with a steel core
- Dispenser with three spare blades
- The bent tail fin efficiently tucks carpets

Stockcode	Total length	Qty/pack	Blade width	Blade length
389340 SNAP-OFF KNIFE SFRPB 18A	193 mm	10 pcs	18mm	100 mm



### Snap-off knife SFRPB 18W



Ergonomic snap-off knife with a bent tail fin. The knife is suitable for all-round use such as cutting plasterboard, insulation, aqua panel and wood. The design with rubberised grip makes it suitable for materials demanding more power. Tapered knife tip with extended front of blade rail for better stability, access and visibility. The bent tail fin efficiently tucks carpets or opens cans. The knife can hold a dispenser with 3 spare blades and is made of durable PC-plastic (polycarbonate) with a steel core for added stability. 1 mm thick metal blade rail for additional stability.

- Used for cutting plasterboard, insulation, aqua panel and wood
- Wheel lock function
- Made of durable PC-plastic with a steel core
- Dispenser with three spare blades
- The bent tail fin efficiently tucks carpets

Stockcode	Qty/pack	Blade width	Blade length
389350 SNAP-OFF KNIFE SFRPB 18W	10 pcs	18mm	100 mm



### Snap-off knife SFPB 18A



Slim snap-off knife with a bent tail fin. The knife is suitable for all-round use such as cutting plastic, paperboard and stripping cables. The slim design makes it easy to keep in the pocket. Tapered knife tip with extended front of blade rail for better stability, access and visibility. The bent tail fin efficiently tucks carpets or opens cans. The knife is made of durable PC-plastic (polycarbonate) with a steel core for added stability. 1 mm thick metal blade rail for additional stability.

- Used for cutting plastic, paperboard, stripping cables and removing silicone residue
- Auto lock function
- Made of durable PC-plastic with a steel core
- Slim and functional design
- The bent tail fin efficiently tucks carpets

Stockcode	Total length	Qty/pack	Blade width	Blade length
389370 SNAP-OFF KNIFE SFPB 18A	193 mm	10 pcs	18mm	100 mm





## Snap-off knife SFPB 18W



Slim snap-off knife with a bent tail fin. The knife is suitable for all-round use such as cutting plastic, paperboard and stripping cables. The slim design makes it easy to keep in the pocket. Tapered knife tip with extended front of blade rail for better stability, access and visibility. The bent tail fin efficiently tucks carpets or opens cans. The knife is made of durable PC-plastic (polycarbonate) with a steel core for added stability. 1 mm thick metal blade rail for additional stability.

- Used for cutting plastic, paperboard, stripping cables and removing silicone residue
- Wheel lock function
- Made of durable PC-plastic with a steel core
- Slim and functional design
- The bent tail fin efficiently tucks carpets

---

Stockcode	Total length	Qty/pack	Blade width	Blade length
389380 SNAP-OFF KNIFE SFPB 18W	193 mm	10 pcs	18mm	100 mm

---

### Snap-Off Knife SPP 9A



The SPP 9A is a robust snap-off knife for precision cuts such as intricate paper cutting or opening boxes. The slim design makes it suitable for all-round use. Tapered for better visibility, access and control. The knife is made of durable PC-plastic (polycarbonate) with a steel core for added stability. Easy to attach to a pocket using the clip which can also be used for safe blade snapping.

- Used to cut paper or open boxes
- Auto lock function that locks the blade in fixed positions
- Removable clip for attaching to a pocket or toolbox
- Symmetric design for right and left-handed usage

Stockcode	Total length	Qty/pack	Blade width	Handle	Blade length
389140 SNAP-OFF KNIFE SPP 9A	147 mm	10 pcs	9mm	Other grip	80 mm

### Snap-Off Knife SPP 18A



The SPP 18A is a robust snap-off knife for all-round use such as cutting plastic, paperboard and stripping cables. The slim design makes it suitable for all-round use. Tapered for better visibility, access and control. The knife is made of durable PC-plastic (polycarbonate) with a steel core for added stability. 1 mm thick metal blade rail for additional stability.

- Used for cutting plastic, paperboard, stripping cables and removing silicone residue
- Auto lock function
- Use the angled tip as a guide for measuring 45 and 90 degrees
- 1 mm thick metal blade rail for additional stability
- Symmetric design for right and left-handed usage

Stockcode	Total length	Qty/pack	Blade width	Handle	Blade length
389150 SNAP-OFF KNIFE SPP 18A	157 mm	10 pcs	18mm	Other grip	100 mm

### Snap-Off Knife SPP 18W



The SPP 18W is a robust snap-off knife for all-round use such as cutting plastic, paperboard and stripping cables. The slim design makes it suitable for all-round use. Tapered for better visibility, access and control. The knife is made of durable PC-plastic (polycarbonate) with a steel core for added stability. 1 mm thick metal blade rail for additional stability.

- Used for cutting plastic, paperboard, stripping cables and removing silicone residue
- Wheel lock function
- Use the angled tip as a guide for measuring 45 and 90 degrees
- 1 mm thick metal blade rail for additional stability
- Symmetric design for right and left-handed usage

Stockcode	Total length	Qty/pack	Blade width	Handle	Blade length
389160 SNAP-OFF KNIFE SPP 18W	157 mm	10 pcs	18mm	Other grip	100 mm

## Snap-Off Knife SFP 18A



The SFP 18A is a robust snap-off knife with a tail fin. The knife is suitable for all-round use such as cutting plastic, paperboard and stripping cables. The slim design makes it suitable for all-round use. Tapered for better visibility, access and control. The tail fin efficiently tucks carpets or opens cans. The knife is made of durable PC-plastic (polycarbonate) with a steel core for added stability. 1 mm thick metal blade rail for additional stability.

- Used for cutting plastic, paperboard, stripping cables and removing silicone residue
- Auto lock function
- The tail fin efficiently tucks carpets or opens cans
- Symmetric design for right and left-handed usage

Stockcode	Total length	Qty/pack	Blade width	Handle	Blade length
389170 SNAP-OFF KNIFE SFP 18A	178 mm	10 pcs	18mm	Other grip	100 mm

## Snap-Off Knife SFP 18W



The SFP 18W is a robust snap-off knife with a tail fin. The knife is suitable for all-round use such as cutting plastic, paperboard and stripping cables. The slim design makes it suitable for all-round use. Tapered for better visibility, access and control. The tail fin efficiently tucks carpets or opens cans. The knife is made of durable PC-plastic (polycarbonate) with a steel core for added stability. 1 mm thick metal blade rail for additional stability.

- Used for cutting plastic, paperboard, stripping cables and removing silicone residue
- Wheel lock function
- The tail fin efficiently tucks carpets or opens cans
- Symmetric design for right and left-handed usage
- Symmetric design for right and left-handed usage. Slim design takes up little space and can be stored in pocket.

Stockcode	Total length	Qty/pack	Blade width	Handle	Blade length
389180 SNAP-OFF KNIFE SFP 18W	178 mm	10 pcs	18mm	Other grip	100 mm

## Snap-Off Knife SRP 18A



The SRP 18A is an ergonomic snap-off knife for all-round use such as cutting plasterboard, insulation, aqua panel and wood. The design with rubberised grip makes it suitable for materials demanding more power. Tapered for better visibility, access and control. The knife is made of durable PC-plastic (polycarbonate) with a steel core for added stability. It comes with 4 blades, 1 in the blade rail and the extra 3 in the dispenser that the knife holds. 1 mm thick metal blade rail for additional stability.

- Used for cutting plasterboard, insulation, aqua panel and wood
- Auto lock function
- Symmetric design for right and left-handed usage
- 1 mm thick metal blade rail for additional stability

Stockcode	Total length	Qty/pack	Blade width	Handle	Blade length
389220 SNAP-OFF KNIFE SRP 18A	156 mm	10 pcs	18mm	Rubber grip	100 mm

### Snap-Off Knife SRP 18W



The SRP 18W is an ergonomic snap-off knife for all-round use such as cutting plasterboard, insulation, aqua panel and wood. The design with rubberised grip makes it suitable for materials demanding more power. Tapered for better visibility, access and control. The knife is made of durable PC-plastic (polycarbonate) with a steel core for added stability. It comes with 4 blades, 1 in the blade rail and the extra 3 in the dispenser that the knife holds. 1 mm thick metal blade rail for additional stability.

- Used for cutting plasterboard, insulation, aqua panel and wood
- Wheel lock function
- 1 mm thick metal blade rail for additional stability
- Symmetric design for right and left-handed usage

Stockcode	Total length	Qty/pack	Blade width	Handle	Blade length
389230 SNAP-OFF KNIFE SRP 18W	156 mm	10 pcs	18mm	Rubber grip	100 mm

### Snap-Off Knife SFRP 18A



The SFRP 18A is an ergonomic snap-off knife with tail fin. The knife is suitable for all-round use such as cutting plasterboard, insulation, aqua panel and wood. The design with rubberised grip makes it suitable for materials demanding more power. Tapered for better visibility, access and control. The tail fin efficiently tucks carpets or opens cans. The knife is made of durable PC-plastic (polycarbonate) with a steel core for added stability. It comes with 4 blades, 1 in the blade rail and the extra 3 in the dispenser that the knife holds. 1 mm thick metal blade rail for additional stability.

- Used for cutting plasterboard, insulation, aqua panel and wood
- Auto lock function
- The tail fin efficiently tucks carpets or opens cans
- Symmetric design for right and left-handed usage
- Use the angled tip as a guide for measuring 45 and 90 degrees.

Stockcode	Total length	Qty/pack	Handle	Blade length
389240 SNAP-OFF KNIFE SFRP 18A	178 mm	10 pcs	Rubber grip	100 mm

### Snap-Off Knife SFRP 18W



The SFRP 18W is an ergonomic snap-off knife with tail fin. The knife is suitable for all-round use such as cutting plasterboard, insulation, aqua panel and wood. The design with rubberised grip makes it suitable for materials demanding more power. Tapered for better visibility, access and control. The tail fin efficiently tucks carpets or opens cans. The knife is made of durable PC-plastic (polycarbonate) with a steel core for added stability. It comes with 4 blades, 1 in the blade rail and the extra 3 in the dispenser that the knife holds. 1 mm thick metal blade rail for additional stability.

- Used for cutting plasterboard, insulation, aqua panel and wood
- wheel lock function
- The tail fin efficiently tucks carpets or opens cans
- Symmetric design for right and left-handed usage
- Use the angled tip as a guide for measuring 45 and 90 degrees.

Stockcode	Total length	Qty/pack	Blade width	Handle	Blade length
389250 SNAP-OFF KNIFE SFRP 18W	178 mm	10 pcs	18mm	Rubber grip	100 mm



### Snap-Off Knife SRP 25A



The SRP 25A is a robust snap-off knife for cutting thick carpets or insulation. The design with rubberised grip makes it suitable for materials demanding more power. Tapered for better visibility, access and control. The knife is made of durable PC-plastic (polycarbonate) with a steel core for added stability. It comes with 4 blades, 1 in the blade rail and the extra 3 in the dispenser that the knife holds. 1 mm thick metal blade rail for additional stability.

- Used for cutting thick carpets or insulation
- Auto lock function
- Made of durable plastic with a steel core
- Symmetric design for right and left-handed usage
- Use the angled tip as a guide for measuring 45 and 90 degrees.

Stockcode	Total length	Qty/pack	Blade width	Handle	Blade length
389260 SNAP-OFF KNIFE SRP 25A	186 mm	6 pcs	25mm	Rubber grip	125 mm

### Snap-Off Knife SRP 25W



The SRP 25W is a robust snap-off knife for cutting thick carpets or insulation. The design with rubberised grip makes it suitable for materials demanding more power. Tapered for better visibility, access and control. The knife is made of durable PC-plastic (polycarbonate) with a steel core for added stability. It comes with 4 blades, 1 in the blade rail and the extra 3 in the dispenser that the knife holds. 1 mm thick metal blade rail for additional stability.

- Used for cutting thick carpets or insulation
- Wheel lock function
- Made of durable plastic with a steel core
- Symmetric design for right and left-handed usage
- Use the angled tip as a guide for measuring 45 and 90 degrees.

Stockcode	Total length	Qty/pack	Handle	Blade length
389270 SNAP-OFF KNIFE SRP 25W	186 mm	6 pcs	Rubber grip	125 mm

### Snap-Off Knife SPP 25A



The SPP 25A is a robust snap-off knife for cutting thick carpets or insulation. The slim design makes it suitable for all-round use. Tapered for better visibility, access and control. The knife is made of durable PC-plastic (polycarbonate) with steel core for added stability. 1 mm thick metal blade rail for additional stability.

- Used for cutting thick carpets or insulation
- Auto lock function
- Made of durable PC-plastic (polycarbonate) with a steel core
- Symmetric design for right and left-handed usage

Stockcode	Total length	Qty/pack	Blade width	Handle	Blade length
389280 SNAP-OFF KNIFE SPP 25A	186 mm	6 pcs	25mm	Other grip	125 mm

## Snap-Off Knife SPP 25W



The SPP 25W is a robust snap-off knife for cutting thick carpets or insulation. The slim design makes it suitable for all-round use. Tapered for better visibility, access and control. The knife is made of durable PC-plastic (polycarbonate) with a steel core for added stability. 1 mm thick metal blade rail for additional stability.

- Used for cutting thick carpets or insulation
- Wheel lock function
- Made of durable PC-plastic (polycarbonate) with a steel core
- Symmetric design for right and left-handed usage

Stockcode	Total length	Qty/pack	Blade width	Handle	Blade length
389290 SNAP-OFF KNIFE SPP 25W	186 mm	6 pcs	25mm	Other grip	125 mm

## Snap-Off Blade Allround



A reliable blade for everyday cutting with excellent sharpness and long life. Developed for all-round usage such as cutting plastic and paperboard, stripping cables and opening boxes. 9 mm blade comes in a pack of 10. 18/25 mm blades come in a practical storage box with 4 dispensers holding 3 spare blades each. The box can be used for snapping blades and safely storing worn-out blades. Recycle worn-out blades as metal scrap.

- Used for cutting plastic, paperboard, stripping cables and opening boxes
- 9 mm blade comes in a pack of 10. 18/25 mm blades come in 4 dispensers holding 3 spare blades each
- Graded to show how many fresh edges there are left
- 8-12 sections per blade, the last blade can also be used
- Available in three widths; 9, 18 and 25 mm

Stockcode	Qty/Pack (pcs)	Qty/pack	Blade width	Blade length	Blade length
389530 SNAP OFF BLADES SBA9-10	10 x 10	10 pcs	9mm	80 mm	80 mm
389630 SNAP OFF BLADES SBA18-4X3	4 x 3	10 pcs	18mm	100 mm	100 mm
389650 SNAP OFF BLADES SBA25-4X3	4 x 3	10 pcs	25mm	125 mm	125 mm

## Snap-off blade Non-segment



A flexible blade for precision work close to the workpiece. Used for removing residues of glue and silicone. Fits snap-off knives that use 18/25 mm wide blades. Recycle worn-out blades as metal scrap.

- Used for removing residues of glue and silicone.
- The blade can be mounted for right or left-handed usage
- Fits snap-off knives that use 18/25 mm wide blades

Stockcode	Qty/Pack (pcs)	Qty/pack	Blade width	Blade length	Blade length
389740 SNAP OFF BLADES SBN18-4X3	4 x 3	10 pcs	18mm	100 mm	100 mm
389770 SNAP OFF BLADES SBN25-4x3	4 x 3	10 pcs	25mm	125 mm	125 mm

## Snap-Off Blade Edge

A blade with extra sharpness for tasks demanding precision. Developed for precision cuts and when cutting plasterboard. 9 mm blade comes in a pack of 10. 18/25 mm blades come in a practical storage box with 4 dispensers holding 3 spare blades each. The box can be used for snapping blades and safely storing worn-out blades. Recycle worn-out blades as metal scrap.



- Developed for precision cuts and when cutting plasterboard
- 9 mm blade comes in a pack of 10. 18/25 mm blades come in 4 dispensers holding 3 spare blades each
- Graded to show how many fresh edges there are left
- Available in three widths; 9, 18 and 25 mm

Stockcode	Qty/Pack (pcs)	Qty/pack	Blade width	Blade length	Blade length
389890 SNAP OFF BLADES SBE9-10	10 x 10	10 pcs	9mm	80 mm	80 mm
389830 SNAPP OF BLADES SBE18-4X3	4 x 3	10 pcs	18mm	100 mm	100 mm
389860 SNAP OFF BLADES SBE25-4X3	4 x 3	10 pcs	25mm	125 mm	125 mm

## Snap-Off Blade Performance

A blade with sharp long-life performance for tougher cuts. Developed for cutting insulation, plasterboard and carpets. Comes in a practical storage box with 4 dispensers holding 3 spare blades each. For 18/25 mm blades the box can be used for snapping blades and safely storing worn-out blades. Recycle worn-out blades as metal scrap.

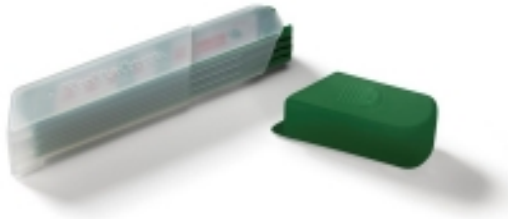

- Developed for cutting insulation, plasterboard and carpets
- Comes in a practical storage box with 4 dispensers holding 3 spare blades each
- Graded to show how many fresh edges there are left
- 8 sections per blade, the last blade can also be used
- Available in two widths; 18 and 25 mm

Stockcode	Qty/Pack (pcs)	Qty/pack	Blade width	Blade length	Blade length
389920 SNAP OFF BLADES SBP18-4X3	4 x 3	10 pcs	18mm	100 mm	100 mm
389940 SNAP OFF BLADES SBP25-4X3	4 x 3	10 pcs	25mm	125 mm	125 mm



## Snap-Off Knife BKZ 18Q

Robust and reliable snap-off knife, ergonomically designed for maximum safety and comfort. Intelligently designed button makes it easy to feed out and lock the blade with a single hand whilst allowing the blade to be safely fixed in position. Supplied with 1 blade.



- Ergonomic design with pronounced finger grip and narrowing tip that affords excellent grip when measuring and cutting plasterboard in a single stroke.
- Extra long and stable blade support prevents blades from snapping off during work, increasing safety.
- The knife has few moving parts and is easy to open for cleaning and replacing blades.
- One click per blade section – the last blade can also be used.

Stockcode	Length	Qty/pack	Blade width	Blade length
389300 SNAP-OFF KNIFE BKZ 18Q	180 mm	6 pcs	18mm	100 mm

## Snap-Off Knife BKP

Practical snap-off knife made from durable PP plastic and designed for quick and simple blade replacement without using tools. Supplied with 1 blade.



- Built-in snap-off blade tool at the back end of the knife for safe blade snapping.
- Quick and easy blade changes without tools.
- The blade locks in fixed positions as it is fed out.
- Available in two sizes – 9 mm and 18 mm..

Stockcode	Total length	Qty/pack	Blade width	Blade length
389310 SNAP-OFF KNIFE BKP 9A	128 mm	10 pcs	9mm	85 mm
389320 SNAP-OFF KNIFE BKP 18A	170 mm	10 pcs	18mm	102 mm



## Saw Knife BK-Z SB

The BK-Z handle combined with the saw blade SB-18 provides this flexible saw. The saw blade is made according to Japanese specifications, it cuts on the backward stroke, meaning that it can be thin and produce a fine, clean sectional cut. The BK-Z handle is ergonomically designed for maximum safety and comfort.



- Smart designed button makes it easy to feed out and lock the blade with a single hand whilst allowing the blade to be safely fixed in position.
- Few parts and easy to open for cleaning and replacing blades.
- The blade is made of SK5 carbon steel, the teeth are hardened to 60-62 HRC.
- The blade is 0.5 mm thick and have 7 teeth per cm.

Stockcode	Length	Qty/pack	Blade width knives
389210 SNAP-OFF KNIFE, Saw blade BK-Z SB	180 mm	10 pcs	18 mm

18 mm

## Saw Blade Snap-Off Knife

x 3

Made according to Japanese specifications, this is a saw blade that cuts on the backward stroke, meaning that it can be thin and produce a fine, clean sectional cut. The saw blade is ideal for your 18 mm snap-off knife.



- Made from SK5 carbon steel.
- The teeth are hardened to 60-62 HRC.
- 0.5 mm thick.
- 7 teeth per cm.
- Fits an 18 mm snap-off knife.

Stockcode	Length	Qty/Pack (pcs)	Qty/pack	Blade width	Fits to
389720 SPARE SAW BLADE SB 18-3	105 mm	10 x 3	10 pcs	18mm	BK-Z



**x 1**

## Glass Scraper

Knife with retractable blade used to easily remove paint and glue from glass and other sensitive surfaces. Supplied with 1 blade.

- Retractable blade for safe storage.
- Quick and easy blade changing.

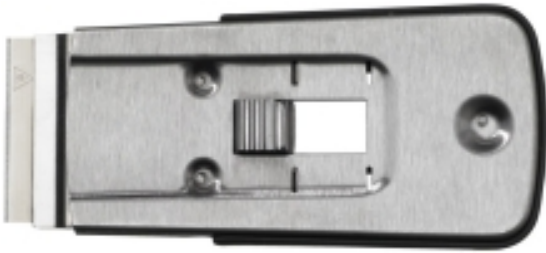

Stockcode	Length	Qty/pack	Blade width
389810 GLASS SCRAPER GS	98 mm	10 pcs	19mm

**19 x 39 mm**

## Spare Blade Glass Scraper

- Made from SK5 carbon steel, hardened to 60-62 HRC.

**x 10**



Stockcode	Length	Qty/Pack (pcs)	Qty/pack	Blade width	Fits to
389820 SPARE BLADE RB GS-10	39 mm	10 x 10	10 pcs	19mm	GS



# Craftsman's knives.

TAILORED TO YOUR REALITY.

When we were developing our craftsman's knives, we got help from the real experts – professional craftsmen. We studied what they did, listened to what they wanted and tried to identify their needs. We made prototypes that were tested by them out in the field, made changes and tested them again. The final result was a unique range of knives tailored specifically to how craftsmen actually work.

## CRAFTSMAN'S KNIFE HVK

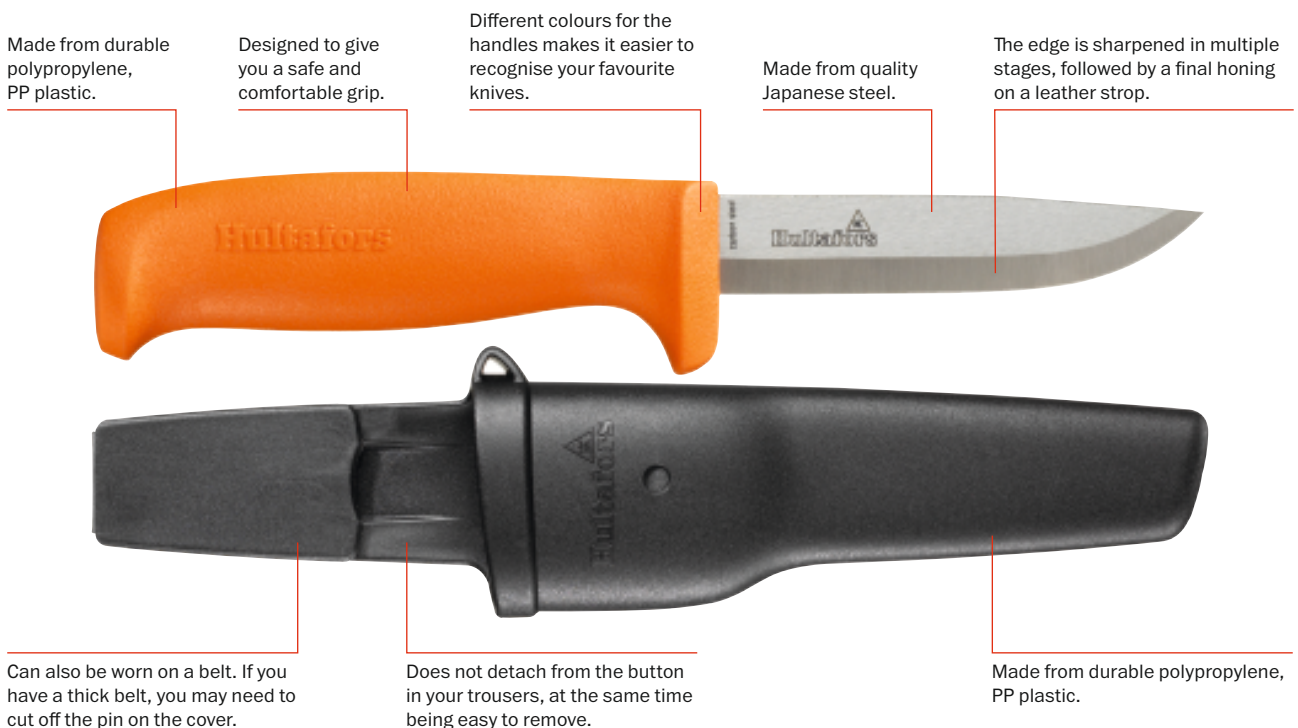

## A knife for you.

UNIQUE RANGE OF KNIVES.

### HEAVY-DUTY AND CHISEL KNIVES

These are powerful and durable knives that can be used for most jobs that require prizing, breaking, chiselling and hacking various different materials.

### PAINTER'S KNIFE

The painter's knife is a triple-function tool. First and foremost, it is a knife, but it is also a screwdriver and a can opener.

### PLUMBER'S KNIFE

As plumbers frequently need to remove burrs from pipes, the plumber's knife features an integrated file on one side of the blade.

### HOLSTER

The holster is attached to a button on your trousers using a unique function that ensures that the holster doesn't come loose whilst still making it easy to remove. Insert the button into the hole, pull the holster down and snap the cover firmly in position. To remove the holster, just undo the cover.

### DOUBLE HOLSTER

If you're used to carrying two knives at the same time, you may benefit from using a double holster. It allows you to easily carry the knife set-up that best suits your requirements.



### Craftsman's Knife HVK

Knife developed and adapted to meet the needs of craftsmen, with a blade made from Japanese knife steel. It features a unique function for attaching the holster around a button on your work clothes so that it does not come loose whilst still being easy to remove. The blade is made from 2.5 mm carbon steel that has been hardened to 58–60 HRC.

- The cutting edge has been sharpened in several stages, with a final honing on a leather strop.
- Both the handle and holster are made from super-durable PP plastic.
- The holster can be attached to both a belt and a button on your work clothes. If your belt is thick, cut away the small pin on the cover.
- Craftsman's knife HVK-PH is supplied with a cardboard case instead of a holster.

Stockcode	Total length	Qty/pack	Blade length
380010 CRAFTSMAN'S KNIFE HVK	208 mm	10 pcs	93 mm
385010 CRAFTSMAN'S KNIFE HVK-PH	208 mm	10 pcs	93 mm
386030 CRAFTSMAN'S KNIFE HVK-28	208 mm	28 pcs	93 mm
386020 CRAFTSMAN'S KNIFE HVK-100	208 mm	100 pcs	93 mm



### Craftsman's Knife HVK GH

Craftsman's knife with friction grip. Developed and adapted to the needs of craftsmen. It features a unique function for attaching the holster around a button on your work clothes so that it does not come loose whilst still being easy to remove. The blade is made from 2.5 mm carbon steel that has been hardened to 58–60 HRC.

- The cutting edge has been sharpened in several stages, with a final honing on a leather strop.
- The handle is made from super-durable PP plastic and fitted with a Santoprene friction grip.
- Fits in the same holster as the HVK model and its double holster.

Stockcode	Total length	Qty/pack	Blade length
380210 CRAFTSMAN'S KNIFE HVK GH	208 mm	10 pcs	93 mm



### Craftsman's Knife RFR

Knife developed and adapted to meet the needs of craftsmen, with a blade made from stainless German knife steel. It features a unique function for attaching the holster around a button on your work clothes so that it does not come loose whilst still being easy to remove. The blade is made from 2.5 mm stainless steel that has been hardened to 57–59 HRC.

- The cutting edge has been sharpened in several stages, with a final honing on a leather strop.
- Both the handle and holster are made from super-durable PP plastic.
- The holster can be attached to both a belt and a button on your work clothes. If your belt is thick, cut away the small pin on the cover.
- Craftsman's knife RFR-PH is supplied with a cardboard case instead of a holster. RFR fits in the same holster as HVK.

Stockcode	Total length	Qty/pack	Blade length	Blade length
380060 CRAFTSMAN'S KNIFE RFR	208 mm	10 pcs	93 mm	93 mm
386070 CRAFTSMAN'S KNIFE RFR-28	208 mm	28 pcs	93 mm	93 mm





### Craftsman's Knife RFR GH

Craftsman's knife with friction grip. Developed and adapted to the needs of craftsmen. It features a unique function for attaching the holster around a button on your work clothes so that it does not come loose whilst still being easy to remove. The blade is made from 2.5 mm German stainless steel that has been hardened to 57–59 HRC.

- The cutting edge has been sharpened in several stages, with a final honing on a leather strop.
- The handle is made from super-durable PP plastic and fitted with a Santoprene friction grip.
- Fits in the same holster as the HVK model and its double holster.

Stockcode	Total length	Qty/pack	Blade length
380260 CRAFTSMAN'S KNIFE RFR GH	208 mm	10 pcs	93 mm



### Heavy Duty Knife GK

A powerful and durable ground knife suitable for tough tasks such as prizing, breaking and hacking. It features a unique function for attaching the holster around a button on your work clothes so that it does not come loose whilst still being easy to remove. The blade is made from Japanese knife steel, 3 mm carbon steel that has been hardened to 58–60 HRC.

- The cutting edge has been sharpened with a double edge angle and a final honing on a leather strop.
- Both the handle and holster are made from super-durable PP plastic.
- The holster can be attached to both a belt and a button on your work clothes. If your belt is thick, cut away the small pin on the cover.
- Because the heavy duty knife is a more powerful tool, it has a larger holster than other knives in the craftsmen range.
- GK-PH is supplied with a cardboard case instead of a holster.

Stockcode	Total length	Qty/pack	Blade length
380020 HEAVY DUTY KNIFE GK	222 mm	10 pcs	94 mm



### Chisel Knife STK

Robust knife with V-ground chisel function. It features a unique function for attaching the holster around a button on your work clothes so that it does not come loose whilst still being easy to remove. The blade is made from Japanese knife steel, 3 mm carbon steel that has been hardened to 58-60 HRC.

- The cutting edge has been sharpened with a double edge angle and a final honing on a leather strop.
- Both the handle and holster are made from super-durable PP plastic.
- The holster can be attached to both a belt and a button on your work clothes. If your belt is thick, cut away the small pin on the cover.

Stockcode	Total length	Qty/pack	Blade length
380070 CHISEL KNIFE STK	201 mm	10 pcs	72 mm









### Safety Knife SK

A knife designed with a dull point, developed and adapted to minimise sticking injuries. It features a unique function for attaching the holster around a button on your work clothes so that it does not come loose whilst still being easy to remove. The blade is made from Japanese knife steel, 2.5 mm carbon steel that has been hardened to 58–60 HRC.

- The cutting edge has been sharpened in several stages, with a final honing on a leather strop.
- Both the handle and holster are made from super-durable PP plastic.
- The holster can be attached to both a belt and a button on your work clothes. If your belt is thick, cut away the small pin on the cover.
- Safety knife SK fits in the same holster as HVK.

Stockcode	Total length	Qty/pack	Blade length
380080 SAFETY KNIFE SK	203 mm	10 pcs	88 mm



### Safety Knife SKR

A knife designed with a dull point, developed and adapted to minimise sticking injuries. It features a unique function for attaching the holster around a button on your work clothes so that it does not come loose whilst still being easy to remove. The blade is made from German knife steel, 2.5 mm stainless steel that has been hardened to 57–59 HRC.

- The cutting edge has been sharpened in several stages, with a final honing on a leather strop.
- Both the handle and holster are made from super-durable PP plastic.
- The holster can be attached to both a belt and a button on your work clothes. If your belt is thick, cut away the small pin on the cover.
- Safety knife SKR fits in the same holster as HVK.

Stockcode	Total length	Qty/pack	Blade length
380090 SAFETY KNIFE STAINLESS ST SKR	203 mm	10 pcs	88 mm



### Electrician's Knife ELK

The sharpening of the blade edges and the design of the handle have been optimized for cable stripping. It features a unique function for attaching the holster around a button on your work clothes so that it does not come loose whilst still being easy to remove. The blade is made from Japanese knife steel, 1.5 mm carbon steel that has been hardened to 58–60 HRC.

- The two edges have been sharpened to be particularly effective when stripping cables.
- Both the handle and holster are made from super-durable PP plastic.
- The holster can be attached to both a belt and a button on your work clothes. If your belt is thick, cut away the small pin on the cover.
- ELK-L has a green handle with edges sharpened for left-handed use.

Stockcode	Total length	Qty/pack	Right handed / Left handed	Blade length
380030 ELECTRICIAN'S KNIFE ELK	158 mm	10 pcs	Right handed	33 mm
383030 ELECTRICIAN'S KNIFE ELK-L	158 mm	10 pcs	Left handed	33 mm



### Electrical Fitter's Knife EFK

The thin blade, the sharpening of the blade edge and the design of the handle has been optimized for cable stripping. It features a unique function for attaching the holster around a button on your work clothes so that it does not come loose whilst still being easy to remove. The blade is made from Japanese knife steel, 1.5 mm carbon steel that has been hardened to 58–60 HRC.

- The thin blade has been sharpened to be particularly effective when stripping cables.
- Both the handle and holster are made from super-durable PP plastic.
- The holster can be attached to both a belt and a button on your work clothes. If your belt is thick, cut away the small pin on the cover.
- Electrical Fitters knife EFK fits in the same holster as ELK.

Stockcode	Total length	Qty/pack	Blade length
380140 ELECTRICAL FITTER'S KNIFE EFK	160 mm	10 pcs	35 mm



### Painter's Knife MK

Knife for painters, designed for use as both a can opener and a slot screwdriver. It features a unique function for attaching the holster around a button on your work clothes so that it does not come loose whilst still being easy to remove. The blade is made from Japanese knife steel, 2.5 mm carbon steel that has been hardened to 58–60 HRC.

- The cutting edge has been sharpened in several stages, with a final honing on a leather strop.
- Both the handle and holster are made from super-durable PP plastic.
- The holster can be attached to both a belt and a button on your work clothes. If your belt is thick, cut away the small pin on the cover.
- Painter's knife MK fits in the same holster as HVK.

Stockcode	Total length	Qty/pack	Blade length
380040 PAINTER'S KNIFE MK	208 mm	10 pcs	93 mm



### Plumber's Knife VVS

Plumber's knife featuring a file that can be used to remove burrs. It features a unique function for attaching the holster around a button on your work clothes so that it does not come loose whilst still being easy to remove. The blade is made from German knife steel, 2.5 mm stainless steel that has been hardened to 57–59 HRC.

- The cutting edge has been sharpened in several stages, with a final honing on a leather strop.
- Both the handle and holster are made from super-durable PP plastic.
- The holster can be attached to both a belt and a button on your work clothes. If your belt is thick, cut away the small pin on the cover.
- The plumber's knife VVS fits in the same holster as HVK.

Stockcode	Total length	Qty/pack	Blade length
380050 PLUMBER'S KNIFE VVS	208 mm	10 pcs	93 mm



CARBON STEEL

## Insulation Knife



A Insulation knife with a 50 mm wide, flexible blade and scale. Its serrated blade makes it easy to cut through all types of insulation wool. Grip-friendly handle made from impact-resistant PP plastic.

- The blade is made from 50 mm wide carbon steel.
- A serrated blade makes it easy to cut through all types of insulation wool.
- Both the handle and holster and made from super-durable PP plastic.

Stockcode	Total length	Qty/pack	Blade length
389010 INSULATION KNIFE FGK	465 mm	5 pcs	316 mm

CARBON STEEL

## Precision Knife PK GH



Craftsman's knife with friction grip adapted to work where more precision is required such as removing burrs on plastic pipes, carving or places with limited access. It features a unique function for attaching the holster around a button on your work clothes so that it does not come loose whilst still being easy to remove. The blade is made from Japanese knife steel, 2.0 mm carbon steel that has been hardened to 58–60 HRC.

- The cutting edge has been sharpened in several stages, with a final honing on a leather strop.
- The handle is made from super-durable PP plastic and fitted with a Santoprene friction grip.
- The holster can be attached to both a belt and a button on your work clothes. If your belt is thick, cut away the small pin on the cover.
- Precision knife PK GH fits in the same holster as HVK.

Stockcode	Total length	Qty/pack	Blade length
380220 PRECISION KNIFE PK GH	195 mm	10 pcs	75 mm

STAINLESS STEEL

## Rope Knife RKR GH



Craftsman's knife with friction grip and serrated blade that is optimized for cutting through hard or tough surfaces as well as ropes and strapping bands especially where tension to the material is applied. It features a unique function for attaching the holster around a button on your work clothes so that it does not come loose whilst still being easy to remove. The blade is made from 2.0 mm German stainless steel that has been hardened to 57–59 HRC.

- The cutting edge has been sharpened in several stages and 60mm of the blade is serrated to increase cutting power.
- The handle is made from super-durable PP plastic and fitted with a Santoprene friction grip.
- The holster can be attached to both a belt and a button on your work clothes. If your belt is thick, cut away the small pin on the cover.
- Rope knife RKR GH fits in the same holster as HVK.

Stockcode	Total length	Qty/pack	Blade length
380230 ROPE KNIFE RKR GH	209 mm	10 pcs	93 mm



## Rescue Knife OKR GH



Craftsman's knife with friction grip and serrated blade that is optimized for cutting through hard or tough surfaces as well as ropes and strapping band especially where tension to the material is applied, designed with a dull point to minimise sharps injuries. It features a unique function for attaching the holster around a button on your work clothes so that it does not come loose whilst still being easy to remove. The blade is made from 2.0 mm German stainless steel that has been hardened to 57–59 HRC.

- The cutting edge has been sharpened in several stages, 60mm of the blade are serrated to increase cutting power and the tip is blunt.
- The handle is made from super-durable PP plastic and fitted with a Santoprene friction grip.
- The holster can be attached to both a belt and a button on your work clothes. If your belt is thick, cut away the small pin on the cover.
- Rescue knife OKR GH fits in the same holster as HVK.

Stockcode	Total length	Qty/pack	Blade length
380240 RESCUE KNIFE OKR GH	206 mm	10 pcs	90 mm



## Outdoor Knife OK1



A powerful and durable outdoor knife with a larger handle suitable for tough tasks in the field. The hardwearing textile belt loop allows up to 80mm wide belts and is equipped with a pocket for a fire starter. The blade has a scandi grind and is made from Japanese knife steel, 3.0 mm carbon steel that has been hardened to 58–60 HRC and has a rust protective electrophoretic deposition coating to withstand corrosion. The grinded spine of the blade is designed for starting a fire with a fire starter.

- The cutting edge has a scandi grind for superior sharpness and is easy to resharpen. A protective electrophoretic deposition coating (EPD) for best rust protection.
- The extra large handle made from super-durable PP plastic and a long tang makes the knife very durable and made to withstand rough usage.
- The textile beltloop allows up to 80mm wide belts and is equipped with a pocket for a fire starter. It is also detachable if you want to attach the holster to the button on your work clothes.
- Grinded spine for use of a fire starter and the scale engraved on blade is optimized for outdoor usage.

Stockcode	Total length	Qty/Pack (pcs)	Qty/pack	Blade length
380110 OUTDOOR KNIFE OK1	225 mm	10 x 3	10 pcs	93 mm



## Outdoor Knife OK4



A durable outdoor knife with friction grip suitable for tough tasks in the field. The hardwearing textile belt loop allows up to 80mm wide belts and is equipped with a pocket for a fire starter. The blade has a scandi grind and is made from Japanese knife steel, 3.0 mm carbon steel that has been hardened to 58–60 HRC and has a rust protective electrophoretic deposition coating to withstand corrosion. The grinded spine of the blade is designed for starting a fire with a fire starter.

- The cutting edge has a scandi grind for superior sharpness and is easy to resharpen. A protective electrophoretic deposition coating (EPD) for best rust protection.
- The handle is made from super-durable PP plastic and fitted with a Santoprene friction grip. A long tang makes the knife very durable.
- The textile belt loop allows up to 80mm wide belts and is equipped with a pocket for a fire starter. It is also detachable if you want to attach the holster to the button on your work clothes.
- Grinded spine for use of a fire starter and the scale engraved on blade is optimized for outdoor usage.

Stockcode	Total length	Qty/pack	Blade length
380270 OUTDOOR KNIFE OK4	209 mm	10 pcs	93 mm

## Fire Steel FS

A long and extra thick fire steel for better function and ergonomics resulting in better efficiency. 100 mm in length and a diameter of 10 mm for a fire steel easy to use in any weather. The sparks generated reach approximately 3000°C. To be used against the spine of Hultafors Outdoor Knives (OK1 and OK4), whose holsters come with fire steel holders.



- The fire steel is easy to hold and the strap provides extra grip.
- The elastic strap makes it easy to secure in the Hultafors fire steel holder.
- Almost impossible to wear out. Good for thousands of strikes.
- Both ends of the fire steel can be struck - more sparks for the money.

---

Stockcode	Total length	Qty/pack
380280 FIRE STEEL FS	100 mm	10 pcs

---







# Advanced knives.

## PLAIN AND SIMPLE.

A really good knife should fit perfectly in your hand and be easy to use. At the same time, it should be safe, reliable and have all the important functions. To make our utility knives as user-friendly as possible, we have eliminated all unnecessary components and minimised the number of moving parts. This not only extends the service life of the knife, as there are fewer parts that can break, it also makes it easier to keep the knives clean.

### URA

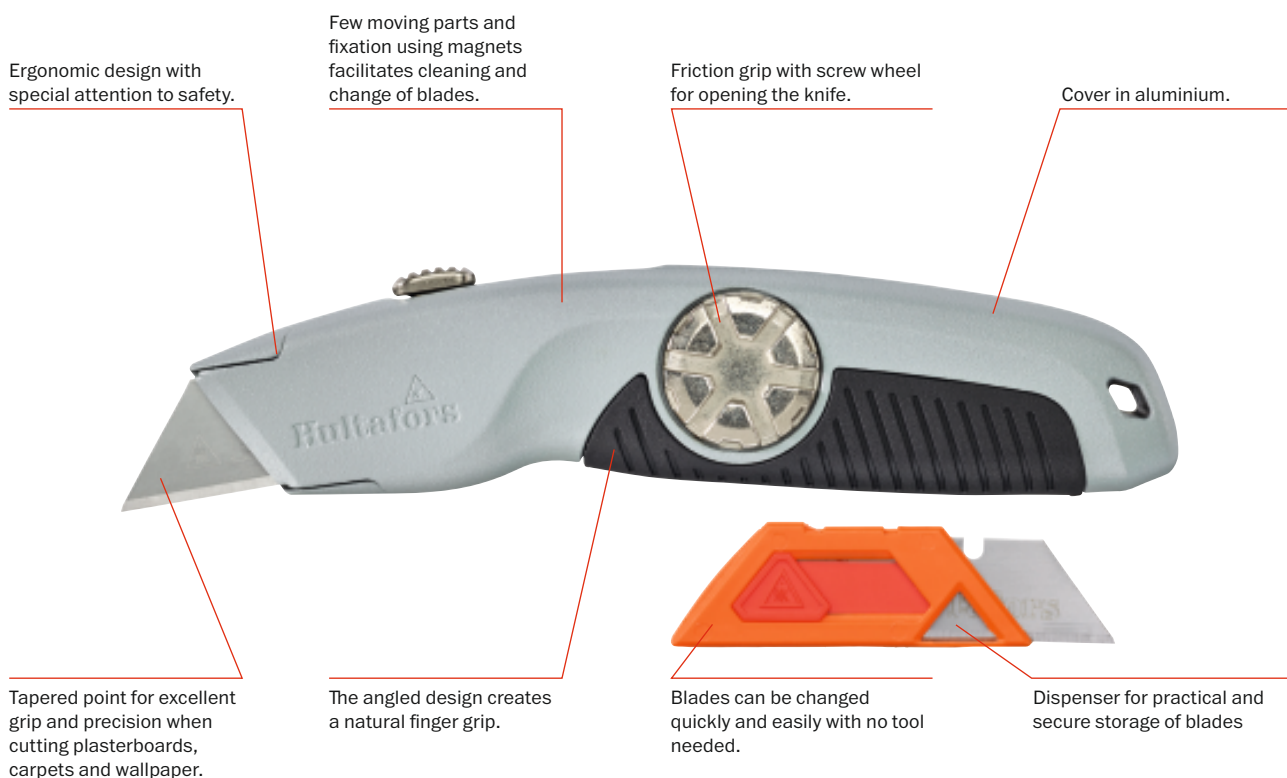

## Specialised blades.

### BLADES WITH A PURPOSE.

We offer a wide range of blades engineered for specific purposes. We offer six specialized blades; the sharp Allround blade, a reliable choice for everyday cutting. The Performance blade adding extra long-life. Edge, bringing extra sharpness. Hook is perfect for floor layers cutting carpets or for cutting roofing felt. Safety comes with a blunt tip. Finally the Stamina blade, made from a secret bi-metal composition designed to push the limits when it comes to sharpness and long service life – an optimal combination of performance and minimizing the carbon footprint.

## Changing the blade.

### STORING BOTH NEW AND WORN OUT BLADES.

On the inside of the handle on our utility knives we have placed a practical spring-loaded dispenser that holds five to ten spare blades. The dispenser can also store worn-out blades so you never have to think about where to place them. The blades can be changed quickly and easily with no extra tools needed.

## Utility Knife URA

Light and efficient utility knife with a great grip, ergonomically designed for best possible safety, comfort and control. A practical screw wheel allows for easy change of blades with no tool needed. Comes with 10 allround blades in a practical dispenser stored inside the knife.



- Ergonomic, angled design with a natural finger grip and a tapered point for an excellent grip when cutting plasterboards.
- Casing in aluminium and friction grip with screw wheel for opening the knife with no tool required.
- Inside the handle a practical springloaded dispenser holds ten spare blades.
- Few moving parts and fixation using magnets facilitates cleaning and change of blades.

Stockcode	Total length	Qty/pack	Blade length
388020 UTILITY KNIFE URA	160 mm	6 pcs	61 mm

## Utility Knife USRA

Light and comfortable safety utility knife with ergonomic design for great grip, control and safety. The blade is pulled back automatically when not under pressure. Blades can be changed quickly and easily with no tool required. Comes with 10 spare blades in a practical, springloaded dispenser which can also store old blades.



- Automatic withdrawal of the blade when not under pressure. For the prevention of stick injuries.
- Ergonomic, angled design with a natural finger grip and a tapered point for an excellent grip when cutting plasterboards.
- Cover in aluminium and friction grip with screw wheel for opening the knife with no tool needed.
- Inside the handle a practical springloaded dispenser holds ten spare safety blades.

Stockcode	Total length	Qty/pack	Blade length
388030 UTILITY KNIFE USRA	160 mm	6 pcs	59 mm

## Utility knife URZ

Sturdy and well-balanced utility knife with ergonomic design for best possible safety, comfort and control. The practical screw wheel allow for easy blade change with no tool required. Comes with ten spare allround blades in a practical dispenser stored inside the knife.



- Ergonomic, angled design with a natural finger grip and a tapered point for an excellent grip when cutting plasterboards.
- Robust casing in zinc with screw wheel for opening the knife with no tool needed.
- Inside the handle a practical springloaded dispenser holds ten spare blades.
- Few moving parts and fixation using magnets facilitates cleaning and change of blades.

Stockcode	Total length	Qty/pack	Blade length
388050 UTILITY KNIFE URZ	160 mm	6 pcs	61 mm

## Utility blade Allround UBA

A great blade with excellent sharpness and long life. Developed for all-round use wherever there is a need for cutting with precision and control. Comes as 10 blades packed in a practical springloaded dispenser for easy blade change. The dispenser fits inside the handle of Hultafors utility knives. Used blades can be stored in the back of the dispenser to keep the workplace safe. Also available in a big size dispenser of 100 blades. 388550 and 388650 will eventually (depending on stock level) replace 388520 and 388620 sometime during 2017.



- Optimized for universal use to match the needs of professional craftsmen
- Made from SK5 carbon steel and hardened to 58-60 HRC.
- 10 blades inside. Just push to dispense a new blade.
- Storage space for used blades to improve safety in the workplace.

Stockcode	Qty/Pack (pcs)	Blade width	Blade length
388550 UTILITY BLADES UBA-10	10 x 10	19mm	61 mm
388560 UTILITY BLADES UBA-100	4 x 100	19mm	61 mm

## Utility blade Hook UBH

A sharp blade with a hook at the tip, developed for floorlaying and similar work, making it easy to cut carpets with ease and control. It is made from hardened carbon steel for long-life sharpness. Comes as 10 blades packed in a practical spring-loaded dispenser for easy blade change. The dispenser fits inside the handle of Hultafors utility knives. Used blades can be stored in the back of the dispenser to keep the workplace safe. Also available as a big size dispenser of 100 blades.



- Hook-shaped blade developed especially for carpet-layers.
- Made from SK5 carbon steel and hardened to 58-60 HRC.
- 10 blades inside. Just push to dispense a new blade.
- Storage space for used blades to improve safety in the workplace.

Stockcode	Qty/Pack (pcs)	Blade width	Blade length
388650 UTILITY BLADES UBH-10	10 x 10	19mm	48 mm
388640 UTILITY BLADES UBH-100	4 x 100	19mm	48 mm

## Utility Blade Edge UBE

A blade with extraordinary sharpness developed for tasks where the demand for precision is higher than usual. Edge is made from hardened SK2 carbon steel. Sharper than our Allround blade though not as robust. Comes as 10 blades packed in a practical spring-loaded dispenser for easy blade change. The dispenser fits inside the handle of Hultafors utility knives. Used blades can be stored on the back of the dispenser to keep the workplace safe.



- Extraordinary sharpness when regular sharpness is not enough.
- Made from SK2 carbon steel and hardened to 58-60 HRC.
- 10 blades inside. Just push to dispense a new blade.
- Storage space for used blades to improve safety at the workplace.

Stockcode	Qty/Pack (pcs)	Blade width	Blade length
388720 UTILITY BLADES UBE-10	10 x 10	19mm	61 mm





**Hilti**

警告



## Utility blade Performance UBP

A blade with extraordinary long-life performance. Made from extra hardened carbon steel for a greater sharpness and extended lifetime compared to the competition. A great choice when big plasterboard jobs awaits. Our Performance blades comes as 10 blades packed in a practical spring-loaded dispenser for easy blade change. The dispenser fits inside the handle of Hultafors utility knives. Used blades can be stored in the back of the dispenser to keep the workplace safe.



- A hard and sharp blade with extra long life
- Made from German L22 carbon steel and hardened to 61 HRC.
- 10 blades inside. Just push to dispense a new blade.
- Storage space for used blades to improve safety in the workplace.

Stockcode	Qty/Pack (pcs)	Blade width	Blade length
388920 UTILITY BLADES UBP-10	10 x 10	19mm	61 mm

## Utility blade Stamina UBX

Extremely durable bi-metal blade developed to offer sharpness and long-life like no other blade. Comes as 5 blades packed in a practical springloaded dispenser for easy blade change. The dispenser fits inside the handle of Hultafors utility knives. Used blades can be stored in the back of the dispenser to keep the workplace safe.



- Extreme sharpness, long-life and durability.
- Made from Bi-Metal and hardened to 61 HRC.
- 5 blades inside. Just push to dispense a new blade.
- Storage space for used blades to improve safety in the workplace.

Stockcode	Qty/Pack (pcs)	Blade width	Blade length
388320 UTILITY BLADES UBX-5	10 x 5	19mm	61 mm

## Utility blade Safety UBS

This blade has a blunt point to minimize the risk for stick injuries, yet still offers full long-life sharpness for cutting with precision and control. Comes as 10 blades packed in a practical spring-loaded dispenser for easy blade change. The dispenser fits inside the handle of Hultafors utility knives. Used blades can be stored in the back of the dispenser to keep the workplace safe.



- Dull point to prevent sticking injuries
- Made from SK5 carbon steel and hardened to 58-60 HRC.
- 10 blades inside. Just push to dispense a new blade.
- Storage space for used blades to improve safety in the workplace.

Stockcode	Qty/Pack (pcs)	Blade width	Blade length
388820 UTILITY BLADES UBS-10	10 x 10	19mm	59 mm



# Double holsters.

QUICK ACCESS TO YOUR FAVOURITES.

By wearing the holster close to hand, the safety-conscious craftsman always has quick access to the knives he or she uses the most, and can thereby work both efficiently and safely. Our double holsters are available in different combinations, depending on the task. The holster is made from impact-resistant PP plastic, joined by rivets and an elastic loop. Once your knives have worn out, keep the holster and use it again with new knives – a great way to minimise the carbon footprint.

## DOUBLE HOLSTER JS+URA

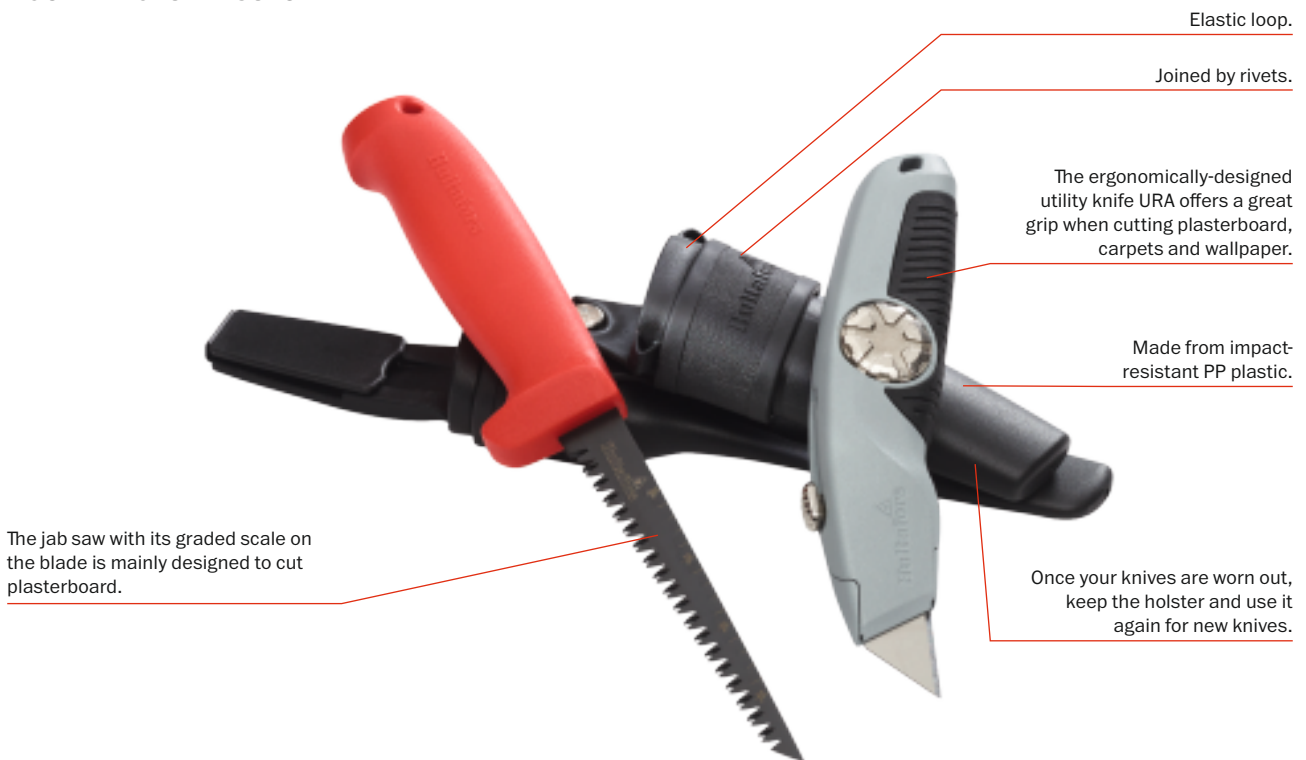

## Find your favourites.

MANY COMBINATIONS.

Our double holsters come in different combinations, all with a purpose. Besides JS+URA we have combinations specially developed for electric work, precision work, tougher tasks and cutting.



## Double holster JS & URA



Double holster JS+URA includes the jab saw JS and the utility knife URA – the perfect combination for anyone cutting plasterboard. A double holster always allows you to have access to the two tools you use the most, allowing your job to be done efficiently. The jab saw with its graded scale on the blade is mainly designed to cut plasterboard and the ergonomically-designed utility knife offers a great grip when cutting plasterboard, carpets and wallpaper. The double holster is made from impact-resistant PP plastic, joined by rivets and an elastic loop. Our double holsters are available in many different combinations.

Stockcode	Total length	Qty/pack	Knife combination
381060 JAB SAW/UTILITY KNIFE JS & URA	263 mm	4 pcs	Jab saw / Utility

## Double holster STK & URA



Double holster STK & URA includes the chisel knife STK and the utility knife URA, ensuring you are well equipped for all tasks. A double holster always allows you to have access to the two knives you use the most, so your job gets done efficiently. The chisel knife is a robust knife with V-shaped ground chisel function. The ergonomically designed utility knife offers great grip when cutting plasterboards, carpets and wallpaper. The double holster is made from impact-resistant PP plastic, joined by rivets and an elastic loop. Our double holsters are available in many different combinations. Once the knives are worn out, keep the holster and re-use it with new knives. A great and easy way to minimize our carbon footprint.

Stockcode	Total length	Qty/pack	Knife combination
381070 CRAFTSMEN/UTILITY KNIFE STK & URA	250 mm	4 pcs	Chisel / Utility

## Double Holster SK & USRA



The Double Safety Combination includes two safety knives; the craftsman's safety knife SK and the safety utility knife USRA. The SK Safety Knife is designed with a dull point, developed and adapted to increase safety and minimize injuries. It's the perfect choice for the craftsman who values safety. The USRA knife is a safety utility knife with automatic withdrawal of the blade to prevent stick injuries, and a tapered point for excellent grip when cutting plasterboards. A double holster always allows you to have access to the two knives you use the most, and your job gets done efficiently. The double holster is made from impact-resistant PP plastic, joined by rivets and an elastic loop. Our double holster is also available in many different combinations. Once your knives are worn out, keep the holster and use it again for new knives. A great way to minimize our carbon footprint!

Stockcode	Total length	Qty/pack	Knife combination
381050 Double Holster SK & USRA	250 mm	4 pcs	Craftsman / Utility



### Double holster HVK & URA



Double holster including the craftsman's knife HVK and the utility knife URA. The craftsman's knife is developed and adapted to meet the different needs of craftsmen, and the ergonomically designed utility knife with its great grip is optimized for efficient cutting of plaster boards, carpets and wallpaper. With these 2 knives close at hand, you can be sure to be well-equipped for all tasks. A double holster always allows you to have access to the two knives you use the most, and your job gets done efficiently. The double holster is made from impact-resistant PP plastic, joined by rivets and an elastic loop. Our double holster is also available in many different combinations. Once your knives are worn out, keep the holster and use it again for new knives. A great way to minimize our carbon footprint!

Stockcode	Total length	Qty/pack	Knife combination
381040 CRAFTSMAN/ UTILITY KNIFE HVK & URA	250 mm	4 pcs	Craftsman / Utility

### Double holster HVK & HVK



Double holster including 2 craftsman's knives HVK. The craftsman's knife is developed and adapted to meet the needs of craftsmen, and the blade is made from 2.5mm carbon steel. With 2 craftsman's knives close at hand, one of them can be used for various tasks, whereas the other one stays sharp for precision work. A double holster always allows you to have access to the two knives you use the most, and your job gets done efficiently. The double holster is made from impact-resistant PP plastic, joined by rivets and an elastic loop. Our double holster is also available in many different combinations. Once your knives are worn out, keep the holster and use it again for new knives. A great way to minimize our carbon footprint!

Stockcode	Total length	Qty/pack	Knife combination
381010 KNIFE DOUBLE HOLSTER HVK & HVK	260 mm	4 pcs	Craftman / Craftman

### Double holster GK & HVK



Double holster including the heavy duty knife GK and the craftsman's knife HVK. The heavy duty knife is a powerful and ground knife suited for tough tasks such as prizing, breaking and hacking. The craftsman's knife is developed and adapted to meet the different needs of craftsmen. With these 2 knives close at hand, you can be sure to be well-equipped for all tasks. A double holster always allows you to have access to the two knives you use the most, and your job gets done efficiently. The double holster is made from impact-resistant PP plastic, joined by rivets and an elastic loop. Our double holster is also available in many different combinations. Once your knives are worn out, keep the holster and use it again for new knives. A great way to minimize our carbon footprint!

Stockcode	Total length	Qty/pack	Knife combination
381020 KNIFE DOUBLE HOLSTER GK & HVK	270 mm	4 pcs	Heavy Duty / Craftman

### Double holster HVK & ELK



Double holster including the craftsman's knife HVK and the electrician's knife ELK. The craftsman's knife is developed and adapted to meet the different needs of craftsmen. The design of the handle and the sharpening of the different blade edges of the electrician's knife, are optimized for cable stripping. With these 2 knives close at hand, you can be sure to be well-equipped prepared for all tasks. A double holster always allows you to have access to the two knives you use the most, and your job gets done efficiently. The double holster is made from impact-resistant PP plastic, joined by rivets and an elastic loop. Our double holster is also available in many different combinations. Once your knives are worn out, keep the holster and use it again for new knives. A great way to minimize our carbon footprint!

Stockcode	Total length	Qty/pack	Knife combination
381030 KNIFE DOUBLE HOLSTER HVK & ELK	210 mm	4 pcs	Craftman / Electrician

### Double holster STK & HVK



Double holster including the chisel knife STK and the craftsman's knife HVK. The chisel knife is a robust knife with V-shaped grinding chisel function, and the craftsman's knife is developed and adapted to meet the different needs of craftsmen. With these 2 knives close at hand, you can be sure to be well equipped for all tasks. A double holster always allows you to have access to the two knives you use the most, and your job gets done efficiently. The double holster is made from impact-resistant PP plastic, joined by rivets and an elastic loop. Our double holster is also available in many different combinations. Once your knives are worn out, keep the holster and use it again for new knives. A great way to minimize our carbon footprint!

Stockcode	Total length	Qty/pack	Knife combination
387010 KNIFE DOUBLE HOLSTER STK & HVK	210 mm	4 pcs	Chisel / Craftman

### Double holster STK & ELK



Double holster including the chisel knife STK and the electrician's knife ELK. The chisel knife is a robust knife with V-shaped grinded chisel function. The sharpening of the blades different edges and the design of the handle of the electrician's knife is optimized for cable stripping. With these 2 knives close at hand, you can be sure to be well-equipped for all tasks. A double holster always allows you to have access to the two knives you use the most, and your job gets done efficiently. The double holster is made from impact-resistant PP plastic, joined by rivets and an elastic loop. Our double holster is also available in many different combinations. Once your knives are worn out, keep the holster and use it again for new knives. A great way to minimize our carbon footprint!

Stockcode	Total length	Qty/pack	Knife combination
387030 KNIFE DOUBLE HOLSTER STK & ELK	220 mm	4 pcs	Chisel / Electrician

## DOUBLE HOLSTER EDC 25 & HVK



Double holster including Chisel EDC 25mm and the Craftsman's knife HVK. The chisel is perfect for all-round use, such as adjusting, fitting, prying and demolishing. The craftsman's knife is developed and adapted to meet the different needs of craftsmen. With these 2 knives close at hand, you can be sure to be well equipped for all tasks. A double holster always allows you to have access to the two knives you use the most, and your job gets done efficiently. The double holster is made from impact-resistant PP plastic, joined by rivets and an elastic loop. Our double holster is also available in many different combinations. Once your knives are worn out, keep the holster and use it again for new knives. A great way to minimize our carbon footprint!

Stockcode	Total length	Qty/pack
391073 DOUBLE HOLSTER EDC 25 & HVK	250 mm	6 pcs





# Award-winning chisels.

SHARP, RELIABLE AND ALWAYS ON HAND.

We decided immediately: our new range of chisels should offer just what professional craftsmen actually need. But we didn't stop there. When we developed our different chisels, we went further than that. The result was not only a series of award-winning chisels that can be likened to handy and durable all-purpose tools, it was also a brand new series of high quality chisels with a unique design and function.

## CHISEL HDC



## EDC CHISELS

When we observed craftsmen at work, it quickly became apparent that they needed a chisel that is easy to carry and can be used for various types of work. This led to Hultafor's EDC chisels – handy chisels with durable blades and sturdy handles that can withstand strong blows from a hammer. The chisels immediately set a new standard and have been awarded both the Red Dot Design Award and the iF Product Design Award.

## HDC CHISELS

In our survey, many craftsmen also called for extremely high quality chisels, which were previously absent from the market. We took them at their word and developed the Hultafor HDC Chisel – a unique chisel with a uniform steel construction, forged in a single piece. A highly robust, sharp and durable chisel for craftsmen who want something extra in terms of strength, function and precision.



## Chisel HDC

Chisels with perfect precision, sharp, heavy duty, and always close at hand. They are ready for tasks requiring extreme strength and precision. A perfect ground blade, bevelled at 25° for the best ratio possible between sharpness and durability. The entire chisel including the handle can be positioned flat against the surface for expanded uses. Smart holster made from durable PP plastic for increased accessibility, the holster can easily be attached to a belt or on a button.

- Forged in one piece with an I-beam going all through for extreme durability and to maximize the force transmission down to the work piece.
- Flat contact surface gives an increased number of applications.
- Santoprene handle, optimized for both power and precision.
- Smart holster for increased availability.
- Replaceable nylon striker available as spare part.

Stockcode	Total length	Qty/pack	Blade width chisels	Spare strikers
390263 CHISEL HDC 20	265 mm	2 pcs	20 mm	390299 .
390273 CHISEL HDC 25	265 mm	2 pcs	25 mm	390299 .
390283 CHISEL HDC 32	265 mm	2 pcs	32 mm	390299 .
390293 CHISEL HDC 40	265 mm	2 pcs	40 mm	390299 .



## Chisel EDC

An everyday chisel, sharp, reliable and always at hand. Ready for tough precision and all-round use, from adjusting and fitting to prying and demolishing. Perfectly sharpened high-quality Japanese steel blade with heavy-duty handle designed for hard hammer blows. Smart holster with a clip for easy access at all times.

- High-quality Japanese steel blade.
- Rust protected by Electrophoretic deposition (EPD).
- Very robust handle.
- Smart holster for protection and easy access.

Stockcode	Total length	Qty/pack	Blade width chisels
390013 CHISEL EDC 6	232 mm	5 pcs	6 mm
390023 CHISEL EDC 10	232 mm	5 pcs	10 mm
390033 CHISEL EDC 12	232 mm	5 pcs	12 mm
390043 CHISEL EDC 16	232 mm	5 pcs	16 mm
390053 CHISEL EDC 18	232 mm	5 pcs	18 mm
390063 CHISEL EDC 20	232 mm	5 pcs	20 mm
390073 CHISEL EDC 25	232 mm	5 pcs	25 mm
390083 CHISEL EDC 32	232 mm	5 pcs	32 mm



## Chisel Set EDC

Set of 5 chisels in various sizes, gathered in a practical canvas bag. An everyday chisel, sharp, reliable and ready for all-around use, such as adjusting and fitting to prying and demolishing. Perfectly sharpened high-quality Japanese steel blade with heavy-duty handle designed for hard hammer blows.

- Stored in a practical canvas casing.
- High-quality Japanese steel blade.
- Rust protected by Electrophoretic deposition (EPD).
- Heavy-duty handle.

Stockcode	Total length	Qty/pack	Blade width
390005 CHISEL SET EDC S5, 6-25	232 mm	1 pcs	6-10-12-16-25



## Outcannel Gouge OGC

A curved chisel, sharpened on the outside, giving a perfect 8mm radius in one stroke. Sharp, reliable and always at hand, perfect for making cable ditches. The gouge features a high-quality Japanese steel blade with a heavy-duty handle designed to withstand repeated hammer blows.

- Perfect for making cable ditches.
- High-quality Japanese steel blade.
- Heavy-duty handle.
- Smart holster for easy access at all time.

Stockcode	Total length	Qty/pack	Radius
390123 OUTCANNEL GOUGE OGC r8	232 mm	5 pcs	8 mm



## Incannel Gouge IGC

A curved chisel, sharpened on the inside, giving a perfect 11mm radius in one stroke. Sharp, reliable and always at hand when installing lock cases and hinges in wooden doors. The gouge features a high-quality Japanese steel blade, rust protected by Electrophoretic deposition (EPD). Heavy-duty handle designed to withstand repeated hammer blows.

- Perfect when installing locks and hinges.
- High-quality Japanese steel blade.
- Heavy-duty handle.
- Smart holster for easy access at all time.

Stockcode	Total length	Qty/pack	Blade width	Radius
390133 INCANNEL GOUGE IGC d22	232 mm	5 pcs	11mm	11 mm



## Chisel Holder CH

Gather your favourite chisel sizes in a unique 3-chisel holder. Makes it easy to keep your chisels together, especially in the tool bag. Made from hardwearing leather. The holder can also be used on a belt or button. (Chisels not included).

- Keep your chisels together.
- Made from hardwearing leather.

Stockcode	Qty/pack
390003 CHISEL HOLDER CH 3	5 pcs







## DOUBLE HOLSTER EDC 25 & HVK



Double holster including Chisel EDC 25mm and the Craftsman's knife HVK. The chisel is perfect for all-round use, such as adjusting, fitting, prying and demolishing. The craftsman's knife is developed and adapted to meet the different needs of craftsmen. With these 2 knives close at hand, you can be sure to be well equipped for all tasks. A double holster always allows you to have access to the two knives you use the most, and your job gets done efficiently. The double holster is made from impact-resistant PP plastic, joined by rivets and an elastic loop. Our double holster is also available in many different combinations. Once your knives are worn out, keep the holster and use it again for new knives. A great way to minimize our carbon footprint!

Stockcode	Total length	Qty/pack
391073 DOUBLE HOLSTER EDC 25 & HVK	250 mm	6 pcs

## Spare Strikers HDC



Stockcode	Total length	Qty/pack	Fits to
390299 SPARE PART HDC SF	200 mm	1 pcs	390263, 390273, 390283, 390293







# Precision in every cut.

A GOOD SAW IS ALL ABOUT EFFICIENCY.

Hultafors offers a complete range of handsaws for any type of challenge and all types of job. Our saws come in different designs; handsaws, bow saws, hack saws and various special saws for cutting most materials, including wood, metal, concrete, and plasterboards. The common denominator for all our saws is precision and control, as we know professional craftsmen expect a great deal from their saws.

## HBX

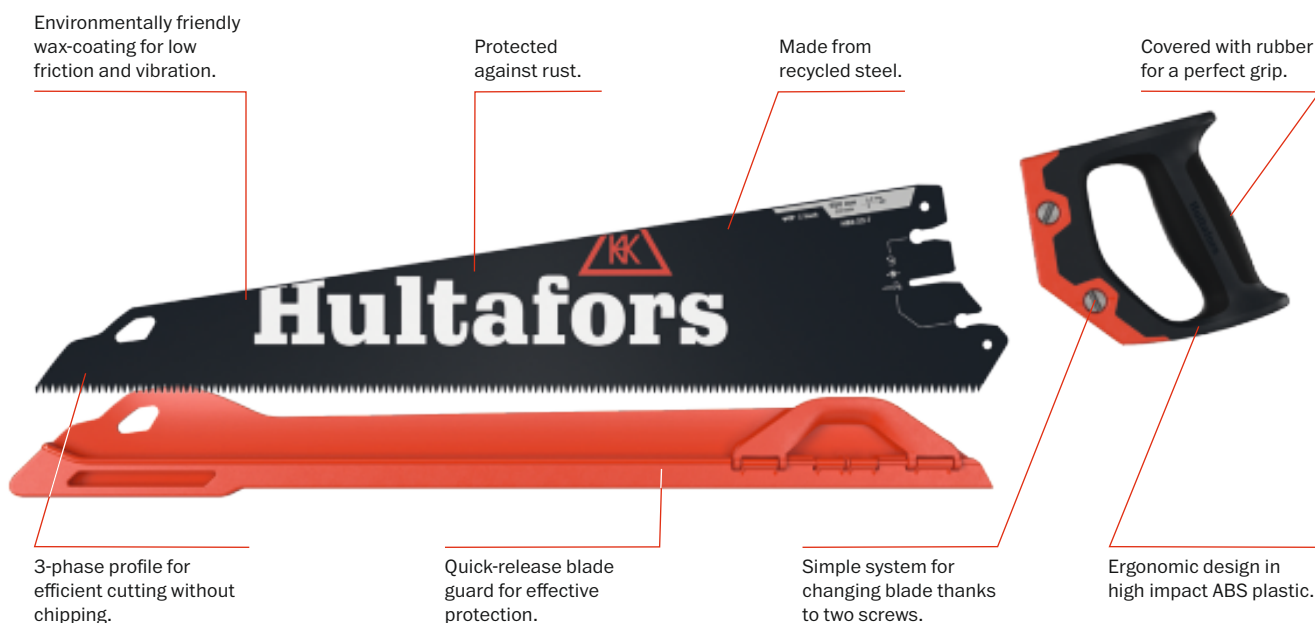

reddot award 2015  
winner

## Choose the right saw.

WHAT IS YOUR CHALLENGE?

### HANSAW

Our handsaws ensure you will get the job done and are a reliable choice for all-round cutting as well as precision work. Our different models are customised depending on how frequently they are used and for what tasks. They are all made in durable material and with the professional user's efficiency in mind.

### BOW SAW

Our range of bow saws includes saws for cutting outdoors as well as on construction sites. The smaller bow saw can also be used with hack saw blades. What they all have in common is the ergonomic design with knuckle protection and efficient blade.

### HACK SAW

Our hack saws are the perfect choice when you need to do precision work. All our hack saws come in handy sizes, from pocket size up to 12 inch. Thanks to high blade tension they all deliver precision cuts, never compromising with efficiency.

### SPECIAL SAWS

Our range of special saws include saws for smaller jobs, like the jab saw and pull saw, as well as for the really tough tasks, such as cutting stone-based material.

## Handsaw HBX



Handsaw developed for the modern craftsmen in close cooperation with professional users. Hultafors unique teeth's with 3-phase grinding combines efficiency and a good bite with nice straight cuts without chipping. The 1mm thick steel blade with a unique eco-friendly wax coating gives less friction and power-consuming side vibrations. The durable three-component handle has a comfortable ergonomic grip and 45 ° and 90 ° angle guide. The handle is mounted to the blade with a stable safety screw which enables changing blade in a simple and reliable way. The narrow blade tip facilitates access in narrow spaces and when to start cutting in the middle of a board.

- Unique teeth's with 3-phase grinding combines efficiency and a long life time.
- Environmentally-friendly wax-based powder coating gives rust protection, less friction and power-consuming side vibrations.
- Reliable, easy and secure system for changing the blade.
- Ergonomic and durable ABS handle.
- A unique and durable blade protection with quick release function.

Stockcode	Qty/pack	Teeth/inch	Blade length	Blade length
590703 HANDSAW HBX HBX-22-7	4 pcs	7	550 mm	22 inch
590704 HANDSAW HBX HBX-22-7	10 pcs	7	550 mm	22 inch
590705 HANDSAW HBX HBX-22-7	24 pcs	7	550 mm	22 inch
590903 HANDSAW HBX HBX-22-9	4 pcs	9	550 mm	22 inch
590904 HANDSAW HBX HBX-22-9	10 pcs	9	550 mm	22 inch
590905 HANDSAW HBX HBX-22-9	24 pcs	9	550 mm	22 inch
591103 HANDSAW HBX HBX-22-11	4 pcs	11	550 mm	22 inch
591104 HANDSAW HBX HBX-22-11	10 pcs	11	550 mm	22 inch
591105 HANDSAW HBX HBX-22-11	24 pcs	11	550 mm	22 inch

## Veneer saw HBX



Professional veneer saw for precision cut and flooring. The blade has a radius shaped tip with teeth in order to make a cut in the center of a board. The blade is lacquered with an environmentally friendly wax based powder coating that provides low friction and good rust protection with a minimal environmental impact. The saw comes with a unique and robust blade cover for easy assembly.

- Ergonomic handle with rubber grip (reusable)
- 1 mm thick blade in C75 quality steel
- Unique 3-phase grinding
- Robust blade protection
- Environmentally friendly wax-based powder coating

Stockcode	Qty/pack	Teeth/inch	Blade length	Blade length
590730 VENEER SAW HBX-14-11-V	2 pcs	11	350 mm	14 inch

## Tenon saw HBX



Professional Tenon saw for precision work as well as cutting with miter tools. The saw blade is reinforced with a "back" for increased stiffness of the saw blade. The sawblade has a tapered shape towards the tip in order to minimize the risk of overcutting the workpiece. The blade is lacquered with an environmentally friendly wax based powder coating that provides low friction and good rust protection with a minimal environmental impact. The saw comes with a unique and robust blade cover.

- Ergonomic handle with rubber grip (reusable)
- 1 mm thick blade in C75 quality steel
- Unique 3-phase grinding
- Robust blade protection
- Environmentally friendly wax-based powder coating

Stockcode	Qty/pack	Teeth/inch	Blade length	Blade length
590740 TENON SAW HBX-14-11-T	2 pcs	11	350 mm	14 inch



## Toolbox saw HBX

Professional Short saw for increased mobility and flexibility. The blade is lacquered with an environmentally friendly wax based powder coating that provides low friction and good rust protection with a minimal environmental impact. The teeth of the saw blade are hardened to give a long life and fine cuts, therefore this product fits perfectly for precision work. The saw comes with a unique and robust blade cover for easy assembly.



- Ergonomic handle with rubber grip (reusable)
- 1 mm thick blade in C75 quality steel
- Unique 3-phase grinding
- Robust blade protection
- Environmentally friendly wax-based powder coating

Stockcode	Qty/pack	Teeth/inch	Blade length	Blade length
590750 TOOLBOX SAW HBX-14-11-S	2 pcs	11	350 mm	14 inch

## Handsaw HBS

A standard saw for universal use with a fiberglass reinforced handle, rubber grip and 45° and 90° angle guide. The handle is mounted with screws for increased durability. The saw blade is made of 1mm thick steel which gives extra stability, precision and low vibrations. Hardened teeth with standard 2-phase grinding for efficiency and a long life time. The narrow blade tip facilitates access in narrow spaces and when to start cutting in the middle of a board.



- Blade of 1mm thick steel provides extra stability, precision and low vibration.
- Fiberglass reinforced handle with rubber grip.
- Basic but durable blade protection included.
- Handsaw HBS is available in a 10-pack or 45-pack display box.

Stockcode	Qty/pack	Blade length	Blade length	Teeth/inch	Blade length	Blade length
590724 HANDSAW HBS HBS-22-7	10 pcs	550 mm	22 inch	7	550 mm	22 inch
590725 HANDSAW HBS HBS-22-7	45 pcs	550 mm	22 inch	7	550 mm	22 inch

## Handsaw HBB

A standard saw for universal use with a high impact handle made of ABS plastic and 45° and 90° angle guide. The handle is ultrasonic welded and the saw blade is made of 0.8mm thick steel. Hardened teeth with standard 2-phase grinding for efficiency and a long life time. The narrow blade tip facilitates access in narrow spaces and when to start cutting in the middle of a board.



- Blade of 0.8mm thick steel.
- Handle made of high impact ABS plastic.
- Basic but durable blade protection included.

Stockcode	Qty/pack	Blade length	Blade length	Teeth/inch	Blade length	Blade length
591223 HANDSAW HBB HBB-22-7	6 pcs	550 mm	22 inch	7	550 mm	22 inch
591224 Segaccio HBB	10 pcs	550 mm	22 inch	7	550 mm	22 inch



## Veneer saw HBB

A Standard Veneer saw that doesn't compromise with quality. The saw has a 0,8 mm thick C75 steel blade for stability and precision. The blade has a radius shaped tip with teeth in order to make a cut in the center of a board. The 2-phase grinding provides a precise and efficient performance in many different materials. The teeth of the saw blade are hardened to give a long life span and the blade has a clear lacquer to provide rust protection. The handle is ergonomically designed in robust ABS plastic for good grip with power and precision. The saw comes with a blade cover that is easy to dismantle and re-assemble when the saw has been used.



- Ergonomic handle
- 0,8 mm thick blade in C75 quality steel
- 2-phase grinding
- Radius shaped tip with teeth

Stockcode	Qty/pack	Teeth/inch	Blade length	Blade length
591230 VENEER SAW HBB-12-12-V	2 pcs	12	300 mm	12 inch

## Tenon saw HBB

A Standard Tenon saw that doesn't compromise with quality. The saw has a 0,8 mm thick C75 steel blade for stability and precision. The saw blade is reinforced with an "back" of aluminum for increased stiffness of the saw blade and to give straight, fine cuts. The sawblade has a tapered shape towards the tip in order to minimize the risk of overcutting the workpiece when making a precise cut. The 2-phase grinding provides a precise and efficient performance in many different materials. The teeth of the saw blade are hardened to give a long life span and the blade has a clear lacquer to provide rust protection. The handle is ergonomically designed in robust ABS plastic for good grip with power and precision. The saw comes with a blade cover that is easy to assemble and dismantle when the saw has been used.



- Ergonomic handle
- 0,8 mm thick blade in C75 quality steel
- 2-phase grinding
- Aluminium reinforced profile

Stockcode	Qty/pack	Teeth/inch	Blade length	Blade length
591240 TENON SAW HBB-12-12-T	2 pcs	12	300 mm	12 inch

## Toolbox saw HBB

A Standard short saw that doesn't compromise with quality. The saw has a 0,8 mm thick C75 steel blade for stability and precision. The 2-phase grinding provides a precise and efficient performance in many different materials. The teeth of the saw blade are hardened to give a long life span and the blade has a clear lacquer to provide rust protection. The handle is ergonomically designed in robust ABS plastic for good grip with power and precision. The saw comes with a blade cover that is easy to assemble and dismantle when the saw has been used.



- Ergonomic handle
- 0,8 mm thick blade in C75 quality steel
- 2-phase grinding

Stockcode	Qty/pack	Teeth/inch	Blade length	Blade length
591250 TOOLBOX SAW HBB-14-12-S	2 pcs	11	350 mm	14 inch

## Hacksaw HMX



A professional hacksaw with a stiff & compact cast aluminum frame for low weight, maximum performance and very high blade tension. The handle is ergonomically shaped with a rubber grip for both hands to maximize the user friendliness. The blade can be tilted for cutting close to a flat surface without loss of performance and precision. The blade tensioner is spring-loaded to support when changing blades and the ergonomically shape helps when creating the very high blade tension. The hacksaw is delivered with Hultafors BI-metal blade (24 TPI) for maximum precision and performance

- Compact cast aluminium frame
- Very high blade tension
- Ergonomic handle with rubber grip
- Spring-loaded blade tensioner

Stockcode	Qty/pack	Teeth/inch	Blade length	Blade length
591300 HACK SAW HMX-12	2 pcs	24	300 mm	12 inch

## Hacksaw HMS



A standard hacksaw with a steel frame for precision, performance and high blade tension. The Ergonomically shaped handle is made from cast aluminum and complemented with a grip friendly plastic support at the front of the frame to maximize the user friendliness. The blade can be tilted for cutting close to a flat surface without loss of performance and precision. The blade tensioner is spring-loaded to support when changing blades and the ergonomically shape helps when creating the high blade tension. The hacksaw is delivered with Hultafors BI-metal blade (24 TPI) for maximum precision and performance.

- Steel frame
- Very high blade tension
- Ergonomic handle with aluminum grip
- Spring-loaded blade tensioner

Stockcode	Qty/pack	Teeth/inch	Blade length	Blade length
591310 HACK SAW HMS-12	2 pcs	24	300 mm	12 inch

## Hacksaw HMM



Compact hacksaw with a frame made of steel profile. An ergonomic handle made in aluminum to provide good support for the hand. Knurled tension to adjust blade tension. The hacksaw is delivered with Hultafors 6" hacksaw blade (32 TPI) for precision and performance.

- Steel frame
- Ergonomic handle in aluminium
- Compact size

Stockcode	Qty/pack	Teeth/inch	Blade length	Blade length
591320 HACK SAW HMM-6	4 pcs	32	150 mm	6 inch



## Hacksaw HMW

A small and versatile hacksaw in pocket size made from steel. The hacksaw is delivered with Hultafors 6" hacksaw blade (32 TPI) for precision and performance.

- Wire frame
- Pocket size



Stockcode	Qty/pack	Teeth/inch	Blade length	Blade length
591330 HACK SAW HMW-6	6 pcs	32	150 mm	6 inch

## Bow saw BSL

Professional bowsaw with an ergonomic handle and knuckle protection to provide a safe and efficient usage. The handle made from PP and rubber provides a very good grip in all different conditions (dry or wet). The metal frame is made in high quality steel with a robust paint to protect from rust. The saw is developed for high durability in order to be used both in the nature and on construction sites. The sawblade is made from high quality steel, C75 and the teeth are hardened and shall not be sharpened with a file. The saw is equipped with a multipurpose saw blade for best performance in both dry and fresh wood. The saw has a more triangular shaped frame in order to provide an improved access in narrow spaces.

- Handle in PP and rubber
- Sawblade in C75-steel
- Hardened teeth
- Triangular designed for optimal access in narrow spaces



Stockcode	Qty/pack	Blade length	Blade length
590801 BOW SAW BSL-21	1 pcs	533 mm	21 inch
590811 BOW SAW BSL-24	1 pcs	610 mm	24 inch
590821 BOW SAW BSL-30	1 pcs	762 mm	30 inch
590831 BOW SAW BSL-12	1 pcs	300 mm	12 inch

## Pull saw

A traditional Ryoba saw with a wooden handle for the authentic feeling. The saw has a 0,5 mm thick blade made from SK5 steel manufactured in Japan. The thin blade provides high flexibility and precision for perfect cuts when making furniture's etc. The blade on a Ryoba has two different grindings in order to perform both when cutting along and across the fibers in the wood, Rip-cut & Cross-cut. The grinding for pulling the saw makes it possible to create precision cuts with a very thin blade together with a minimal force. The teeth is hardened for maximum life span and sharpness. The blade is antirust treated, do not forget to clean the blade and protect it with some oil to maintain the protection over time.

- 0,5 mm thin blade in SK5-steel
- 2 different grindings - Rip + Cross cut
- Hardened teeth
- Anti-rust treated blade
- Traditional wooden handle



Stockcode	Qty/pack	Blade length	Blade length
591270 PULL SAW PSX	2 pcs	240 mm	9.5 inch

## Jab saw

A jab saw mainly designed to make cuts in plasterboards but also to be used as a small versatile saw in the garden or forest. The blade is made in 1,6 mm high quality SK5 steel for increased stability and precision. The blade is 3-phase grinded to secure high efficiency without making damage to surrounding materials. The blade is antirust treated, do not forget to clean the blade and protect it with some oil to maintain the protection over time. The saw is equipped with an ergonomic handle made from a robust PP material and a hole to make it possible to attach a securing device when used at heights. The saw is delivered with a robust holster for safe usage and increased mobility.



- 1,6 mm thick SK5-steel
- 3-phase grinding
- Ergonomic handle in robust PP
- Hole in handle to attach security device
- Graded scale on the blade

Stockcode	Qty/pack	Teeth/inch	Blade length	Blade length
591260 JAB SAW JS	8 pcs	8	130 mm	5 inch

## Concrete saw

A saw for cutting porous stone based material. The blade is made of 1,6 mm C75 steel for stiffness and 34 carbide teeth for efficiency and a long life span. The saw has a wooden handle that is easy to clean.



- 1,6 mm thick C75-steel
- 34 carbide teeth
- Easy-to-clean wooden handle
- Black coated blade

Stockcode	Qty/pack	Teeth/inch	Blade length	Blade length
590760 CONCRETE SAW HC-28-34-C	2 pcs	1.5	700 mm	28 inch

## Sawblade HBX

The HBX sawblade is available with three tooth sizes: 7, 9, 11 teeth/inch, for various applications. Hultafors unique teeth's with 3-phase grinding combines efficiency and a good bite with nice straight cuts without chipping. The 1mm thick steel blade with a unique eco-friendly wax coating gives less friction and power-consuming side vibrations.



- Unique teeth's with 3-phase grinding combines efficiency and a long life time.
- The 1mm thick steel blade gives less friction and power-consuming side vibrations.
- Environmentally-friendly wax-based powder coating for rust protection and less friction.

Stockcode	Qty/pack	Teeth/inch	Blade length	Blade length
590713 SAWBLADE BX BX-22-7	4 pcs	7	550 mm	22 inch
590913 SAWBLADE BX BX-22-9	4 pcs	9	550 mm	22 inch
591113 SAWBLADE BX BX-22-11	4 pcs	11	550 mm	22 inch

## Hacksaw Spare blade

12" Spare Blade for Hacksaw with 18/24 TPI for cutting metal bars, profile and tubes  
 Made in Bi-metal for high performance and durability. 6" Spare blade for Hacksaw  
 with 32 TPI for sheet metal and small bars profiles and tubes. Made in SK5 steel.

- Bi-metal/SK5
- TPI 18/24/32
- 12"/12"/6"



Stockcode	Intended for	Qty/Pack (pcs)	Teeth/inch	Blade length	Blade length
591340 HACK SAW BLADE HM-12-18x2	591300, 591310	20 x 2	18	300 mm	12 inch
591350 HACK SAW BLADE HM-12-24x2	591300, 591310	20 x 2	24	300 mm	12 inch
591360 HACK SAW BLADE HM-6-32x5	591320, 591330	10 x 5	32	150 mm	6 inch

## Bow saw blade BS

Spare sawblade is made from high quality steel, C75 and the teeth are hardened and shall not be sharpened with a file. The saw blade is made for multipurpose for best performance in both dry and fresh wood. The blade is anti rust protected and delivered in sleeves of 1 pieces in each sleeve.

- C75 Steel
- Multipurpose usage
- 12"/21"/24"/30"



Stockcode	Intended for	Qty/pack	Blade length	Blade length
591001 BOW SAW BLADE BS-12	590831	1 pcs	300 mm	12 inch
591021 BOW SAW BLADE BS-21	590801	1 pcs	533 mm	21 inch
591041 BOW SAW BLADE BS-24-D	590811	1 pcs	610 mm	24 inch
591061 BOW SAW BLADE BS-30	590821	1 pcs	762 mm	30 inch



881051

**Hultafors**



# Compact power.

ERGONOMIC AND EASY TO USE.

Professional craftsmen know what a difference it makes to really be able to trust their tools. This is especially the case for clamps, which are often used to hold or stabilise a work project quickly. Hultafors' quick clamps and screw clamps are ergonomic, durable and easy to use – ensuring a long-lasting reliable clamping force.

## QCX QUICK CLAMP

Compact and user-friendly quick clamp with a one-hand grip.



## Two types of clamps.

FOR RELIABLE SUPPORT WHEN NEEDED.

### QCX/QC QUICK CLAMPS

Quick and handy or extreme clamping force? If you ask professional craftsmen about quick clamps, they usually answer that the clamps must be quick to put into place and have enough clamping force to do the job well. That is why we have prioritised a neat, compact and ergonomic design using durable materials. This ensures that Hultafors' Quick Clamps are easy to use and effective with enough clamping force to work securely.

### CF/CFP/CM SCREW CLAMPS

Sturdy, neat and good grip for easy use with substantial clamping force. Hultafors' screw clamps have been developed to simplify the work of professional craftsmen. The powerful CM model is made from impact resistant malleable castings. The rail is grooved on both sides to minimise the risk of the leg sliding when the clamp is being attached. The CFP screw clamp with its chrome coated die-cast rail has a pivoting handle to provide greater force when tightening and loosening.



## Quick Clamp QC

Compact and user-friendly quick clamp with a one-hand grip and a clamping force of up to 90 kg. Steel rail forged in one piece, with a slim front jaw for increased access in narrow spaces. Pressure plates with tracked rubber pads to protect the surface and provide an increased clamping force. Hardened rod and bricks for durable and high performance. Reversible head enabling both internal and external attachment. Housing made of fiberglass-reinforced nylon.

- Slim front jaw for increased access in narrow spaces
- Quick and easy clamping operations
- Reversible head enabling both internal and external attachment
- Clamping force of up to 90 kg
- End protection with a hole for hanging

Stockcode	Qty/pack	Weight	Clamping cap.	Throat depth	Rail dim.
520153 QUICK CLAMP QC 15	2 pcs	600 g	150 mm	75 mm	20 x 6 mm
520303 QUICK CLAMP QC 30	2 pcs	710 g	300 mm	75 mm	20 x 6 mm
520453 QUICK CLAMP QC 45	2 pcs	850 g	450 mm	75 mm	20 x 6 mm
520603 QUICK CLAMP QC 60	2 pcs	980 g	600 mm	75 mm	20 x 6 mm



## Quick Clamp QCX

Compact and user-friendly quick clamp with a one-hand grip, a clamping force of up to 120 kg and a throat depth 20 mm wider than the QC model. Steel rail forged in one piece, with a slim front jaw for increased access in narrow spaces. Pressure plates with tracked rubber pads to protect the surface and provide an increased clamping force. Hardened rod and bricks for durable and high performance. Reversible head enabling both internal and external attachment. Housing made of fiberglass-reinforced nylon.

- Slim front jaw for increased access in narrow spaces
- Quick and easy clamping operations
- Reversible head enabling both internal and external attachment
- Clamping force of up to 120 kg
- End protection with a hole for hanging

Stockcode	Qty/pack	Weight	Clamping cap.	Throat depth	Rail dim.
521153 QUICK CLAMP QCX 15	2 pcs	650 g	150 mm	95 mm	20 x 6 mm
521303 QUICK CLAMP QCX 30	2 pcs	800 g	300 mm	95 mm	20 x 6 mm
521453 QUICK CLAMP QCX 45	2 pcs	920 g	450 mm	95 mm	20 x 6 mm
521603 QUICK CLAMP QCX 60	2 pcs	1050 g	600 mm	95 mm	20 x 6 mm

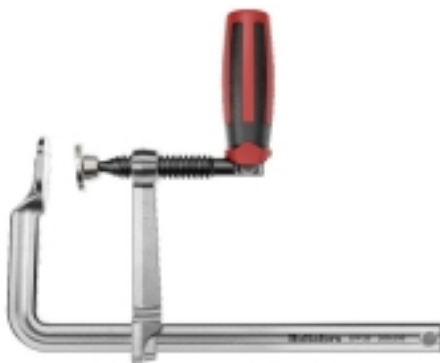

## Screw Clamp CFP, pivoted handle

Steel rail forged in one piece, profiled, nickel and chrome plated. Pivoting handle for increased clamping pressure. Slim front anvil for increased access in narrow places. Strong flat threaded, black phosphate screw with tilted pressure plate.

- Pivoting handle for increased clamping pressure.
- Slim front anvil for increased access in narrow places.
- Tilted pressure plate.
- Clamping force up to 700kg.

Stockcode	Qty/pack	Weight	Clamping cap.	Throat depth	Rail dim.
522203 FORGED SCREW CLAMP PIVO CFP 20	2 pcs	1050 g	200 mm	100 mm	19,5 x 9,5 mm
522253 FORGED SCREW CLAMP PIVO CFP 25	2 pcs	1400 g	250 mm	120 mm	22 x 10,5 mm
522303 FORGED SCREW CLAMP PIVO CFP 30	2 pcs	1950 g	300 mm	140 mm	25 x 12 mm
522403 FORGED SCREW CLAMP PIVO CFP 40	2 pcs	2600 g	400 mm	175 mm	27 x 13 mm

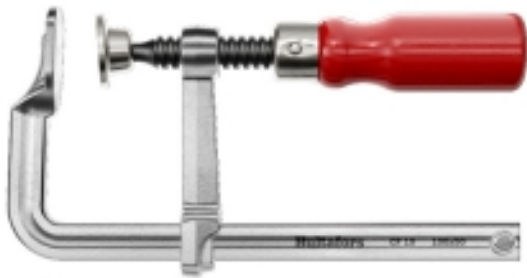

## Screw Clamp CF

Steel rail forged in one piece, profiled, nickel and chrome plated with wooden handle. Slim front anvil for increased access in narrow places. Strong flat threaded, black dyeing screw with tilted pressure plate.

- Slim front anvil for increased access in narrow places.
- Tilted pressure plate.
- Clamping force up to 670kg.

Stockcode	Qty/pack	Weight	Clamping cap.	Throat depth	Rail dim.
523103 FORGED SCREW CLAMP CF 10	2 pcs	200 g	100 mm	50 mm	11,5 x 5,7 mm
523123 FORGED SCREW CLAMP CF 12	2 pcs	300 g	120 mm	60 mm	13,5 x 6,5 mm
523163 FORGED SCREW CLAMP CF 16	2 pcs	500 g	160 mm	80 mm	16 x 7,5 mm
523203 FORGED SCREW CLAMP CF 20	2 pcs	900 g	200 mm	100 mm	19,5 x 9,5 mm
523253 FORGED SCREW CLAMP CF 25	2 pcs	1300 g	250 mm	120 mm	22 x 10,5 mm
523303 FORGED SCREW CLAMP CF 30	2 pcs	1900 g	300 mm	140 mm	25 x 12 mm
523403 FORGED SCREW CLAMP CF 40	2 pcs	1500 g	400 mm	120 mm	22 x 10,5 mm
523503 FORGED SCREW CLAMP CF 50	2 pcs	1700 g	500 mm	120 mm	22 x 10,5 mm



## Screw Clamp CM

A strong clamp with jaws of impact resistant malleable castings and a wooden handle. Profiled rail of nickel and chrome plated steel with grooves on both sides to prevent the slider from slipping at fixation. Strong flat threaded, black dyeing screw with tilted pressure plate and plastic protective caps.

- Profiled and ribbed steel rail.
- Anvil with plastic protection caps.
- Tilted pressure plate.
- Jaw with support foot.
- Clamping force up to 500 kg.

Stockcode	Qty/pack	Weight	Clamping cap.	Throat depth	Rail dim.
524123 MOLDED SCREW CLAMP CM 12-6	2 pcs	450 g	120 mm	60 mm	20 x 5 mm
524163 MOLDED SCREW CLAMP CM 16-8	2 pcs	750 g	160 mm	80 mm	25 x 6 mm
524203 MOLDED SCREW CLAMP CM 20-10	2 pcs	1150 g	200 mm	100 mm	27 x 7 mm
524253 MOLDED SCREW CLAMP CM 25-8	2 pcs	850 g	250 mm	80 mm	25 x 6 mm
524263 MOLDED SCREW CLAMP CM 25-12	2 pcs	1500 g	250 mm	120 mm	29 x 9 mm
524303 MOLDED SCREW CLAMP CM 30-12	2 pcs	1600 g	300 mm	120 mm	29 x 9 mm
524313 MOLDED SCREW CLAMP CM 30-14	2 pcs	2050 g	300 mm	140 mm	32 x 10 mm
524403 MOLDED SCREW CLAMP CM 40-14	2 pcs	2250 g	400 mm	140 mm	32 x 10 mm
524413 MOLDED SCREW CLAMP CM 40-17	2 pcs	2350 g	400 mm	175 mm	32 x 10 mm
524503 MOLDED SCREW CLAMP CM 50-12	2 pcs	1950 g	500 mm	120 mm	29 x 9 mm



## Ratchet Clamp RC

One-hand clamp with ratchet function allows different clamping forces. Fiberglass reinforced nylon with 2-component handles and plastic pressure plates.

- Swivel pressure plates.
- Ratchet function.
- Friction grip.

Stockcode	Qty/pack	Weight	Clamping cap.	Throat depth
525383 RATCHET CLAMP RC 38	2 pcs	80 g	38 mm	32 mm
525583 RATCHET CLAMP RC 58	2 pcs	200 g	58 mm	55 mm







# Demolish with quality.

## WIDE RANGE OF WRECKING BARS.

When working on ripping out windows or room furnishings, it is important that you choose a tool that is as easy to handle as possible. In such instances, a wrecking bar is exactly what you need. We produce a range of different bars, including levers, crowbars/wrecking bars and pry bars, in several different designs and materials. You will always be able to find one that satisfies your requirements.

### WRECKING BAR STEEL ADJUSTABLE 209 SB

Adjustable claw in nine steps for best working position.

Thanks to its gear ring, it can handle the same stresses as a standard wrecking bar.

Made of high quality steel.

Optimised for pulling out nails.

Wide, ground contact surfaces and thin ends make it easy to use and reduce the risk of leaving marks.

Secure strap function.

Ergonomic rubber-clad handle.

The curved section at the handle makes space for the hand and minimizes the risk of crushing damage.



reddot design award  
best of the best 2012

## Steel or aluminium.

### WILL OF STEEL OR FLEXIBLE AS ALUMINIUM.

Steel is almost three times as heavy as aluminium, but it is also three times as strong. When doing work where weight and power is critical to achieving a good result, steel is the obvious choice. Aluminium is easier to work with and gentler on the materials you work with. It doesn't rust, is more resistant to cold and is much more flexible. An aluminium tool can be "bent" about three times as much as a steel tool without being deformed making it ideal for fitting and adjusting within the engineering industry.

## Ergonomical tips.

### BE KIND TO YOUR BODY.

To help you steer clear of any injuries, we've come up with a few tips. Always work with a straight back, but try to avoid working with straight arms. You should also avoid working with bent wrists. The best thing to do is to try and change your work posture as often as you can. Also try to avoid getting into too many situations that involve jerking and wrenching. It's also good to know that aluminium is considerably gentler on your body, particularly when working at shoulder height or above.

LEARN MORE ABOUT  
WRECKING BARS AT PAGE 200

## Wrecking Bar Steel Adjustable 209 SB



Wrecking bar manufactured in high quality steel with ergonomic rubber-clad handle. Articulated claw, adjustable to nine different positions. Wide, ground contact surfaces and thin ends make it easy to use and reduce the risk of leaving marks. The claw is optimised for pulling out nails. The curved section at the chisel makes space for the hand and minimizes the risk of crushing damage.

- Adjustable claw in nine steps for best working position.
- Wide, ground contact surfaces and thin ends make it easy to use in narrow spaces and reduce the risk of leaving marks.
- Optimised claw for pulling out nails.
- Secure strap function.

Stockcode	Length	Qty/pack	Weight	Adjustable
824115 Wrecking Bar Steel Adj. 209 SB/25"	640 mm	2 pcs	1730 g	Yes

## Wrecking Bar Steel 109



Wrecking bar made from hardened, high-alloy boron steel. Wide, ground contact surfaces and thin ends make it easy to use in narrow spaces and reduce the risk of leaving marks.

- Made from hardened, high-alloy boron steel.
- Wide, ground contact surfaces and thin ends make it easy to use in narrow spaces and reduce the risk of leaving marks.
- The claw is optimised for pulling out nails.

Stockcode	Length	Qty/pack	Weight	Adjustable
824009 STEEL WRECKING BAR 109/12"	300 mm	2 pcs	450 g	No
824010 STEEL WRECKING BAR 109/20"	500 mm	2 pcs	1100 g	No
824011 STEEL WRECKING BAR 109/25"	625 mm	2 pcs	1450 g	No
824012 STEEL WRECKING BAR 109/28"	710 mm	2 pcs	1950 g	No
824013 STEEL WRECKING BAR 109/36"	900 mm	2 pcs	2850 g	No

## Wrecking bar steel 109/25" TD



Wrecking bar made from hardened, high quality steel. Wide, ground contact surfaces and thin ends make it easy to use in narrow spaces and reduce the risk of leaving marks. It has three different functions that are optimised for pulling out nails.

- The claw and chisel are optimised for pulling out nails.
- Made from hardened, high quality steel.
- Wide, ground contact surfaces and thin ends make it easy to use in narrow spaces and reduce the risk of leaving marks.

Stockcode	Length	Qty/pack	Weight	Adjustable
824021 WRECKING BAR STEEL 109 109/25"TD	640 mm	2 pcs	1480 g	No

## Wrecking Bar Steel 107

Steel wrecking bar made to a slightly simpler design.



Stockcode	Length	Qty/pack	Weight	Adjustable
824005 STEEL CROWBAR 107/16"	400 mm	2 pcs	750 g	No
824001 STEEL CROWBAR 107/21"	525 mm	2 pcs	900 g	No
824002 STEEL CROWBAR 107/24"	600 mm	2 pcs	1550 g	No
824003 STEEL CROWBAR 107/27"	675 mm	2 pcs	1750 g	No
824004 STEEL CROWBAR 107/30"	750 mm	2 pcs	2000 g	No

## Wrecking Bar Steel 108

A small, versatile steel wrecking bar that can be used for pulling out nails and for breaking, scraping and lifting.



- Has three different functions for pulling out nails.
- Can be used for breaking, scraping and lifting.

Stockcode	Length	Qty/pack	Weight	Adjustable
827013 STEEL CROWBAR 108/15"	380 mm	2 pcs	650 g	No
827043 STEEL CROWBAR 108/21"	530 mm	2 pcs	860 g	No

## Wrecking Bar Steel 108 MINI

A small, useful steel 7.5" wrecking bar that can be used to pull small nails, remove wood strips or to open cans.



- Has three different functions for pulling out nails.
- Thin contact surfaces make it easy to use in narrow spaces.

Stockcode	Length	Qty/pack	Weight	Adjustable
827023 STEEL CROWBAR 108 Mini	190 mm	5 pcs	77 g	No

## Wrecking Bar Steel 101

A small wrecking bar with a claw at one end and a straight chisel at the other. Used as an all-round tool in car workshops and for assembly work in the mechanical industry.

- Has underside support to provide extra strength.



---

Stockcode	Length	Qty/pack	Weight	Adjustable
824000 STEEL CROWBAR 101 B	330 mm	2 pcs	550 g	No

---



## Bending Bar Aluminum H 700

Aluminum bending bar. Used as a practical tool within industry. Originally developed to remove ice from wheels and to test the brakes on train carriages.

- Aluminum is lighter and easier to work with.
- Gentler to the material you work with.
- An aluminum tool does not rust and can better withstand cold conditions.



Stockcode	Length	Qty/pack	Weight
841021 ALUMINIUM ALLOY BAR H 700	680 mm	2 pcs	700 g

## Bending Bar Aluminum H 700 B

Aluminum bending bar with bent tip. Originally produced to test wheel bearings on cars, but also used by locksmiths to adjust door fittings.

- Aluminum is lighter and easier to work with.
- Gentler to the material you work with.
- An aluminum tool does not rust and can better withstand cold conditions.



Stockcode	Length	Qty/pack	Weight
841022 ALUMINIUM ALLOY BAR H 700 B	680 mm	2 pcs	700 g

## Bending Bar Aluminium F 430

Aluminium bending bar with cone shaped tip. Used to fit flanges together with bolt holes and to gently bend copper pipes. A very widely used tool for fitting body parts for cars.

- Aluminium is lighter and easier to work with.
- Gentler to the material you work with.
- An aluminium tool does not rust and can better withstand cold conditions.



Stockcode	Length	Qty/pack	Weight
841010 ALUMINIUM PRY BAR F 430	430 mm	2 pcs	400 g

## Bending Bar Aluminum F 820

Aluminum bending bar with cone shaped tip. Used to fit flanges together with bolt holes and to gently bend copper pipes. A very widely used tool for fitting body parts.

- Aluminum is lighter and easier to work with.
- Gentler to the material you work with.
- An aluminum tool does not rust and can better withstand cold conditions.



Stockcode	Length	Qty/pack	Weight
841011 ALUMINIUM ALLOY BAR F 820	820 mm	2 pcs	1700 g

## Bending Bar Aluminum H 480 B

Aluminum bending bar with bent tip. This is a shorter version of the H700 pry bar, which can fit in a toolbox. Usually used in car workshops to adjust wheel alignment.

- Aluminum is lighter and easier to work with.
- Gentler to the material you work with.
- An aluminum tool does not rust and can better withstand cold conditions.



Stockcode	Length	Qty/pack	Weight
841020 ALUMINIUM ALLOY BAR H 480 B	480 mm	2 pcs	500 g

## Pinch Bar Steel 207



Pinch bar made from 6-square high quality steel. A wide and thin chisel make it easy to use in narrow spaces. The long and cone shaped tip is used for e.g. the mating of flange with bolt holes. The cone tip facilitates the installation of O-rings.

- A wide and thin chisel to increase accessibility.
- Long and evenly grinded cone shaped tip.
- Unpainted cone and chisel to avoid discoloration.

Stockcode	Length	Qty/pack	Weight
824031 PINCH BAR STEEL 207/400	400 mm	2 pcs	580 g
824032 PINCH BAR STEEL 207/500	500 mm	2 pcs	760 g
824033 PINCH BAR STEEL 207/600	600 mm	2 pcs	926 g

## Pry Bar Steel SP



Steel pry bar that can handle high loads and work on stony and hard ground.

- The bar is made from high-grade steel to ensure the best possible level of user safety.
- Model SP 7 PIK is 1500 mm and spike sharpened.

Stockcode	Total length	Length	Qty/pack	Weight
826003 IRON BAR SP 5	1200 mm	1200 mm	1 pcs	5000 g
826004 IRON BAR SP 6	1350 mm	1350 mm	1 pcs	6000 g
826005 IRON BAR SP 7	1500 mm	1500 mm	1 pcs	7000 g
826006 IRON BAR SP 8	1640 mm	1650 mm	1 pcs	8000 g
826055 IRON BAR SP 7 PIK	1550 mm	1500 mm	1 pcs	7000 g

## Pry Bar Steel BLS



Steel pry bar with a steel ball welded onto the handle.

- Made from high-grade steel to ensure the best possible level of user safety.

Stockcode	Total length	Length	Qty/pack	Weight
843020 STEEL PRY BAR BLS 1150	1144 mm	1150 mm	1 pcs	6000 g

## Pry Bar Steel HHS

Steel pry bar for work on stony and hard ground.



Stockcode	Length	Qty/pack	Weight
865501 IRON BAR HOBBY HHSP 1500	1500 mm	1 pcs	6800 g

## Pry Bar Aluminum

Aluminum weighs only 1/3 as much as steel, which means that tools made from it are lighter and easier to work with. Used for applications such as prizing items onto truck platforms and ripping up formwork.



- Aluminum pry bars are lighter and easier to work with, especially when working at shoulder height.
- Gentler to the material you work with.
- An aluminum tool does not rust, has better resistance to cold and is also more flexible than steel tools.
- It can be bent about three times as much as a steel tool without being deformed.

Stockcode	Total length	Length	Qty/pack	Weight
841000 ALUMINIUM PRY BAR B 1200	1200 mm	1200 mm	1 pcs	2100 g
841002 ALUMINIUM PRY BAR B 1500	1500 mm	1500 mm	1 pcs	2800 g

## Pry Bar Aluminum, With Steel Point

Aluminum pry bar is lighter and easier to work with, especially when working at shoulder height. The steel point is required if the bar is to be used to strike and cut.



- The steel point is used to strike and cut.
- An aluminum tool does not rust, has better resistance to cold and is also more flexible than steel tools.
- It can be bent about three times as much as a steel tool without being deformed.

Stockcode	Length	Qty/pack	Weight
841001 ALUMINIUM PRY BAR B 1200 S	1200 mm	1 pcs	2700 g
841003 ALUMINIUM PRY BAR B 1500 S	1500 mm	1 pcs	3600 g
841006 STEEL POINT SPARE PART B STEEL POINT	230 mm	1 pcs	1100 g



## Pry Bar Aluminum, with Steel Point

An aluminum pry bar that also can endure breaking work. The steel point makes it able to withstand high breaking loads.

- Manufactured in "Aerospace aluminum" for high strength and less flexing.
- Aluminum pry bars are lighter and easier to work with, especially when working at shoulder height.
- An aluminum tool does not rust, and has better resistance to cold temperatures.
- It can be bent about three times as much as a steel tool without being deformed.
- The tip is made of hardened steel 'SB-27' and it will therefore last for a long time.



Stockcode	Length	Qty/pack	Weight
841014 ALUMINIUM PRY BAR A 1500 SR	1500 mm	1 pcs	3200 g

## Pry Bar Aluminium, with Pinch Point

Able to withstand high breaking loads. The bent point prevents you trapping your fingers close to the floor. Can be used when tear down moulds.

- Manufactured in "Aerospace aluminium" for high strength and less flexing.
- Aluminium pry bars are lighter and easier to work with, especially when working at shoulder height.
- An aluminium tool does not rust, and has a better resistance to cold.
- It can be bent about three times as much as a steel tool without being deformed.
- The tip is made of hardened steel 'SB-27' and will therefore last for a long time.



Stockcode	Length	Qty/pack	Weight
841024 Aluminium alloy bar A 1500 SB	1500 mm	1 pcs	3200 g



**Hultafors**

# A smarter way to carry.

FOR AN EASIER WORKDAY.

The classic toolbox is often left behind in the craftsman's van or trailer. Instead many craftsmen put the few tools they expect to use in a regular bucket – a simple and practical solution yet with many limitations, not least when it comes to ergonomics.

Hultafors Tool Bucket is as simple as it is clever. With its smart details, ergonomic shape and comfortable handle you get a tool carrier that saves both your body and your wallet. For an easier workday and a professional appearance.

## TOOL BUCKET



## Ergonomical design.

SAVING YOUR BODY.

The rear side of the tool bucket is shaped in order to improve the ergonomics when carrying it. The back is rounded so you can carry it close to the body without bouncing against it on every step. The handle is comfortable and could be placed in an upright position in order to simplify the next lift of the tool bucket. As a bonus the tool bucket is stackable and equipped with a measuring scale on the inside.







## Tool Bucket

Ergonomic tool bucket made of robust PP-plastic material for versatile use such as carrying tools or necessities. The rear side is shaped in order to improve the ergonomics when carrying the product. The handle is comfortable and could be placed in an upright position in order to simplify the next lift of the tool bucket. The tool bucket is stackable and equipped with a measuring scale on the inside.

- Robust handle for comfortable carrying. Handle can be put in standing position when put down.
- Holes for attaching a shoulder strap.
- Measuring scale on the inside.
- Can take a burden of 100 kilograms.
- Made of durable PP-plastic



Stockcode	Volume	Weight	Qty/pack
590101 TOOL BUCKET TB-15	15 L	0.93 kg	1 pcs
590100 TOOL BUCKET TB-15x14 display	15 L	14.5 kg	14 pcs





# Put your company in focus.

Hultafors can offer advertising print on a number of different models of folding rules, pencils and knives. On folding rules, the advertising print can be placed on the section and/or the side. Note that the printed surface may differ from model to model. Folding rules with advertising print are supplied as standard in packs of 10 (plastic foil) without an EAN code on the folding rule.



## COLOURS

- Hultafors can offer printing in the following standard colours as per the Pantone scale "Solid Coated", HKS and RAL.
- Photo print in CMYK.
- Note that minor colour variations may occur.

## PRINT AREA

- The print area is suitable for logotypes, company names, texts and photo prints in 4 colour CMYK.
- Photo print can be ordered on all folding rules.

## EXPLANATIONS PRINT AREA, FOLDING RULES

RE = Print side. The folding rule has a standard scale on the end sections, which only allows for a print area on the side (section printing not available). The print area is suitable for logos, company names or other texts and images.

## FÖ = UPPER FIELD SECTION PRINT + PRINT SIDE.

The upper half of both end sections of the rule are available as a print area. Company name, telephone number, e-mail address or short slogans can be placed here. Can be combined with print along the side of the rule.

## MF = MIDDLE FIELD SECTION PRINT + PRINT SIDE.

Comparable with FÖ (upper field), but the print area is located in the centre of the end sections for unhindered use of the scale on both sides of the rule. Can be combined with print along the side of the rule.

## PROOFING

- Image / photo in the form of logotype or other vectorised image must be enclosed with the proof order as an open EPS file or PDF file.
- Resolution should be greater than 300 dpi for images and photos.
- Hultafors will be happy to provide information on technology, software and equipment. The file must also include information on colours.
- Attached photographs must be in JPG, TIF or PNG format.
- For incomplete files, an additional charge will be made to make the file printable.
- A proof consists of one or more blocks that are numbered. These blocks can be used for subsequent proofing, for example if a block is to be replaced but the others are to remain.
- A block can be used for a subsequent proof order if the product is the same.

### Advertising Print 59-2-10 RE

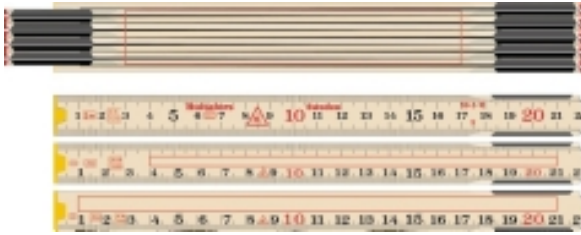

Stockcode	Parts	Hultafors - Colour	Print area	Qty/pack	Length (m)
100009 WOODEN FOLDING RULE 59-2-10 RE	10 pcs	Natural	140x21 mm	10 pcs	2 m
100014 WOODEN FOLDING RULE 59-2-10 MF	10 pcs	Natural	170x4 mm	10 pcs	2 m
100024 WOODEN FOLDING RULE 59-2-10 FÖ	10 pcs	Natural	200x6 mm	10 pcs	2 m

### Advertising Print 59-2-12 RE



Stockcode	Parts	Hultafors - Colour	Print area	Qty/pack	Length (m)
100109 WOODEN FOLDING RULE 59-2-12 RE	12 pcs	Natural	110x27 mm	10 pcs	2 m
100114 WOODEN FOLDING RULE 59-2-12 MF	12 pcs	Natural	147x4 mm	10 pcs	2 m
100124 WOODEN FOLDING RULE 59-2-12 FÖ	12 pcs	Natural	165x6 mm	10 pcs	2 m

### Advertising Print 59-1-6 RE



Stockcode	Parts	Hultafors - Colour	Print area	Qty/pack	Length (m)
100209 WOODEN FOLDING RULE 59-1-6 RE	6 pcs	Natural	110x10 mm	10 pcs	1 m



### Advertising Print 61-2-10 RE

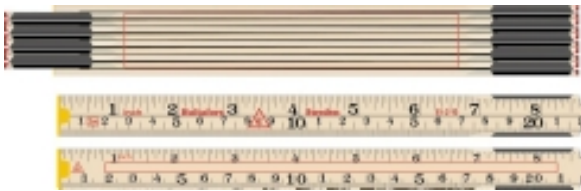

Stockcode	Parts	Hultafors - Colour	Print area	Qty/pack	Length (m)
100509 WOODEN FOLDING RULE 61-2-10 RE	10 pcs	Natural	140x21 mm	10 pcs	2 m
100514 WOODEN FOLDING RULE 61-2-10 MF	10 pcs	Natural	190x6 mm	10 pcs	2 m

### Advertising Print 61-1-6 RE



Stockcode	Parts	Hultafors - Colour	Print area	Qty/pack	Length (m)
100709 WOODEN FOLDING RULE 61-1-6 RE	6 pcs	Natural	110x10 mm	10 pcs	1 m

### Advertising Print 559-2-10 RE



Stockcode	Parts	Hultafors - Colour	Print area	Qty/pack	Length (m)
101809 WOODEN FOLDING RULE 559-2-10 RE	10 pcs	Natural	140x21 mm	10 pcs	2 m



### Advertising Print G59-2-10 RE



Stockcode	Parts	Hultafors - Colour	Print area	Qty/pack	Length (m)
200009 FIBREGLASS FOLDING RULE G59-2-10 GU RE	10 pcs	Yellow	180x24 mm	10 pcs	2 m
200069 FIBREGLASS FOLDING RULE G59-2-10 VI RE	10 pcs	White	180x24 mm	10 pcs	2 m

### Advertising Print G59-2-12 RE



Stockcode	Parts	Hultafors - Colour	Print area	Qty/pack	Length (m)
200109 FIBREGLASS FOLDING RULE G59-2-12 GU RE	12 pcs	Yellow	130x27 mm	10 pcs	2 m

### Advertising Print G59-1-6 RE



Stockcode	Parts	Hultafors - Colour	Print area	Qty/pack	Length (m)
200209 FIBREGLASS FOLDING RULE G59-1-6 GU RE	6 pcs	Yellow	130x10 mm	10 pcs	1 m

### Advertising Print G59-1-10 RE

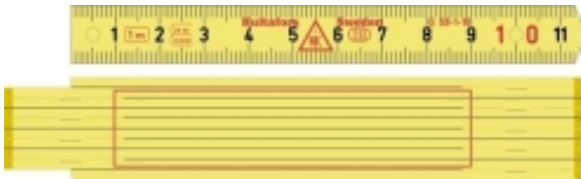

Stockcode	Parts	Hultafors - Colour	Print area	Qty/pack	Length (m)
200309 FIBREGLASS FOLDING RULE G59-1-10 GU RE	10 pcs	Yellow	90x17,5 mm	10 pcs	1 m
200369 FIBREGLASS FOLDING RULE G59-1-10 VI RE	10 pcs	White	90x17,5 mm	10 pcs	1 m

### Advertising Print G61-2-10 RE



Stockcode	Parts	Hultafors - Colour	Print area	Qty/pack	Length (m)
200409 FIBREGLASS FOLDING RULE G61-2-10 GU RE	10 pcs	Yellow	180x24 mm	10 pcs	2 m

### Advertising Print G61-1-6 RE



Stockcode	Parts	Hultafors - Colour	Print area	Qty/pack	Length (m)
200509 FIBREGLASS FOLDING RULE G61-1-6 GU RE	6 pcs	Yellow	130x10 mm	10 pcs	1 m



## Advertising Print Pencils

Print area 80x8 mm. Positioned 75 mm from the end of the pencil. Minimum quantity 600.



Stockcode	Print area	Length	Qty/pack	Hardness
650209 CARPENTER'S PENCIL SNP 18 RÖD RE	80x8 mm	180 mm	200 pcs	HB
650709 CARPENTERS PENCIL SNP 18 SVART RE	80x8 mm	180 mm	200 pcs	HB
650409 CARPENTER'S PENCIL SNP 24 BLÅ RE	80x8 mm	240 mm	200 pcs	HB
650309 CARPENTER'S PENCIL BEP 30 GRÖN RE	80x8 mm	300 mm	200 pcs	10 H

## Advertising Print Craftsman's Knife HVK

Put your company name in focus. We offer advertising print on Craftsman's Knife HVK. Print area 1 = 25x10 mm, print area 2 = 62x19 mm. Minimum order quantity 300 pcs.



Stockcode	Print area 2	Print area 1
380019 CRAFTSMAN'S KNIFE HVK RE >300 ST	62x19 mm	25x10 mm

## Advertising Print Craftsman's Knife RFR

Put your company name in focus. We offer advertising print on Craftsman's Knife RFR. Print area 1 = 25x10 mm, print area 2 = 62x19 mm. Minimum order quantity 300 pcs.



Stockcode	Print area 2	Print area 1
380069 CRAFTSMAN'S KNIFE RFR RE >300ST	62x19 mm	25x10 mm

### Advertising Print Safety Knife SK

Put your company name in focus. We offer advertising print on Safety Knife SK. Print area 1 = 25x15 mm, print area 2 = 62x19 mm. Minimum order quantity 300 pcs.



Stockcode	Print area 2	Print area 1
380089 SAFETY KNIFE SK RE >300 ST	62x19 mm	25x15 mm

### Advertising Print Craftsman's Knife HVK GH

Put your company name in focus. We offer advertising print on Craftsman's Knife HVK GH. Print area 1 = 25x15 mm, print area 2 = 62x19 mm. Minimum order quantity 300 pcs.



Stockcode	Print area 2	Print area 1
380099 SAFETY KNIFE SKR RE >300 ST	62x19 mm	25x15 mm

### Advertising Print Painter's Knife MK

Put your company name in focus. We offer advertising print on Painter's Knife MK. Print area 1 = 25x10 mm, print area 2 = 62x19 mm. Minimum order quantity 300 pcs.



Stockcode	Print area 2	Print area 1
380049 PAINTER'S KNIFE MK RE >300 ST	62x19 mm	25x10 mm

### Advertising Print Plumber's Knife VVS

Put your company name in focus. We offer advertising print on Plumber's Knife VVS. Print area 1 = 25x10 mm, print area 2 = 62x19 mm. Minimum order quantity 300 pcs.



Stockcode	Print area 2	Print area 1
380059 PLUMBER'S KNIFE VVS RE >300 ST	62x19 mm	25x10 mm

### Advertising Print Heavy Duty Knife GK

Put your company name in focus. We offer advertising print on Heavy Duty Knife GK. Print area 1 = 30x14 mm, print area 2 = 62x19 mm. Minimum order quantity 300 pcs.



Stockcode	Print area 2	Print area 1
380029 HEAVY DUTY KNIFE GK RE > 300 ST	62x19 mm	30x14 mm

### Advertising Print Electrician's Knife ELK

Put your company name in focus. We offer advertising print on Electrician's Knife ELK. Print area 1 = 25x15 mm, print area 2 = 18x19 mm. Minimum order quantity 300 pcs.



Stockcode	Print area 2	Print area 1
380039 ELECTRICIAN'S KNIFE ELK RE >300 ST	18x19	25x15 mm

### Advertising Print Craftsman's Knife RFR GH

Put your company name in focus. We offer advertising print on Craftsman's Knife RFR GH. Print area 1 = 25x10 mm, print area 2 = 62x19 mm. Minimum order quantity 300 pcs.



Stockcode	Print area 2	Print area 1
380269 CRAFTSMAN'S KNIFE RFR GH RE>300ST	62x19 mm	25x10 mm

### Advertising Print Chisel Knife STK

Put your company name in focus. We offer advertising print on Plumber's Knife VVS. Print area 1 = 30x14 mm, print area 2 = 62x19 mm. Minimum order quantity 300 pcs.



Stockcode	Print area 2	Print area 1
380079 CHISEL KNIFE STK RE > 300 ST	62x19 mm	30x14 mm

### Advertising Print Handsaw HBS

A standard handsaw with fiberglass reinforced handle and a 1mm thick steel blade. Minimum number of handsaws 90 pcs.



Stockcode	Print area	Qty/pack	Teeth/inch	Blade length	Blade length
590729 HANDSAW HBS, ADV HBS-22-7 RE, >90pcs	200x58 mm	10 pcs	7	550 mm	22 inch
590726 HANDSAW HBS, ADV HBS-22-7 RE, >90pcs	200x58 mm	45 pcs	7	550 mm	22 inch



## Advertising Print Handsaw HBB

A standard saw for universal use with a high impact handle made of ABS plastic and 45° and 90° angle guide. The handle is ultrasonic welded and the saw blade is made of 0.8mm thick steel.

- Blade of 0.8mm thick steel.
- Handle made of high impact ABS plastic.
- Basic but durable blade protection included.

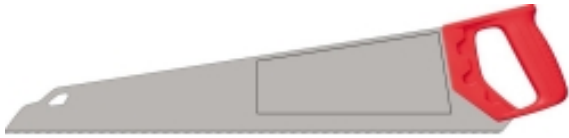

Stockcode	Print area	Qty/pack	Teeth/inch	Blade length	Blade length
591229 Handsaw HBB, ADV Print HBB-22-7 RE	200x58 mm	10 pcs	7	550 mm	22 inch



# Learn more about our tools.

If used correctly your tools will stay faithful to you for many years. On the following pages we share our top tips both of how to use our tools in the best way and how to take care of them. This will not only help you to be more efficient at work – as a bonus it will make your tools last longer. That is, a win-win situation for you as well as the planet.



# Blade types.

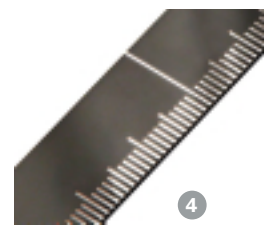
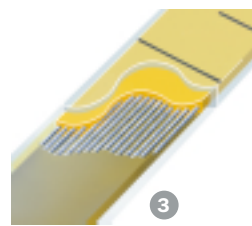
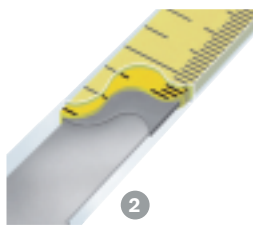

## 1. LACQUERED STEEL TAPE

An impact resistant steel tape covered by an anti-corrosion phosphorous layer that is then painted yellow or white. The scale is protected by a coating of matt polyester lacquer. Can withstand contact with most common solvents, but should not be folded. Also available in stainless steel, making the tape highly resistant to corrosion and wear.

## 2. NYLON COATED STEEL TAPE

A steel tape covered by an anti-corrosion phosphorous layer and then painted yellow. The scale is protected by a nylon coated. Treated with an extra thick nylon membrane to make the tape really durable. Withstands contact with the majority of chemicals, solvents and other liquids. Can also be bent, twisted and crushed without any problem.

## 3. FIBREGLASS TAPE

A tape measure made from fibreglass threads cast in plastic. Can withstand contact with the majority of chemicals, moisture, water and temperature fluctuations. A fibreglass tape can be bent, is lighter and more flexible to work with. The tape is non-conductive and is therefore safe to use when working in close proximity to sources of electricity.

## 4. STAINLESS STEEL TAPE

A premium quality deep etched stainless steel blade. Suitable for use in areas where solvents and chemicals are heavily used. (TR range only).



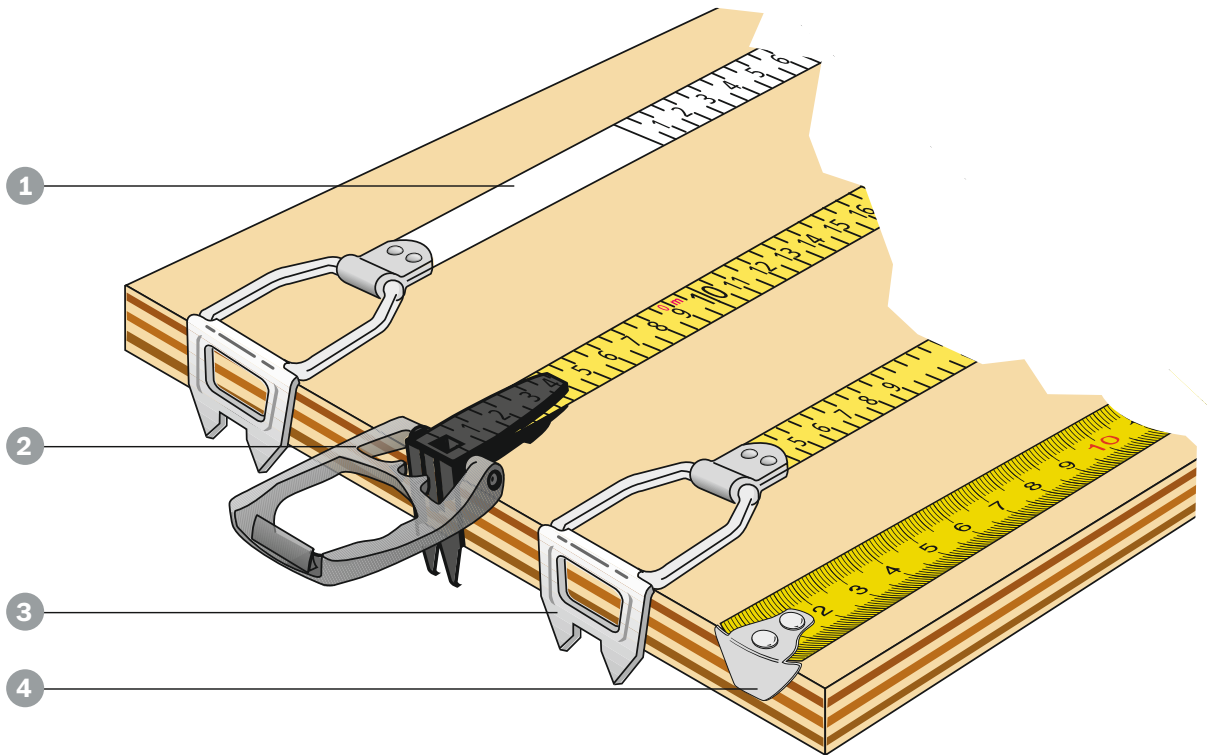

## Long tape measures

### 1. TYPE A START.

The scale starts 100 mm in from the outer edge of the end hook. Used primarily on long tape measures that can measure longer distances and normally require two people to operate. Available on PL, PC and TR tape models.

### 2. TYPE B START.

The scale starts where the hook attaches to the tape. Ideally suited for solo measurement applications. Available on CC, CC F and SY models.

### 3. TYPE C START.

The scale starts at the outer edge of the end hook. Ideally suited for solo measurement applications. Available on model PL, YL and PC tapes.

## Short tape measures

4. The scale starts immediately at the end fitting. Ideally suited for both internal and external measurement. Available on model BT, PR and SL tapes.

# Marking measures TALMETER.

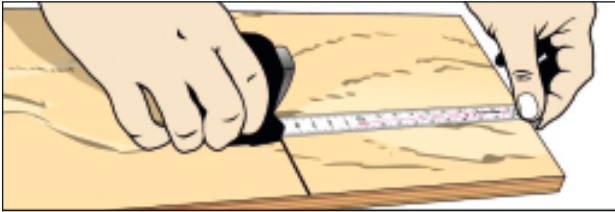

The number of measurement units that the length comprises can be read from reading the indicators against the scale. However, if it is possible to etch the length directly on the workpiece, actually reading the measurement becomes completely unnecessary.

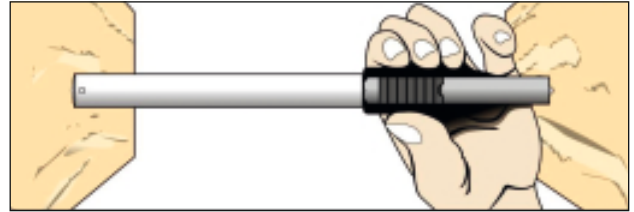

The fold-out extender is designed to make internal measurements just as easy to take as external measurements.



The combined measurement and marking edges allow you to take your measurement and then transfer that measurement to your workpiece.

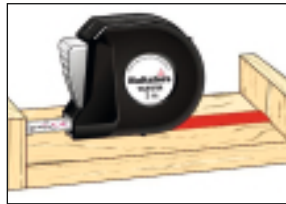

Measure internal lengths just as quickly and simply as external lengths.

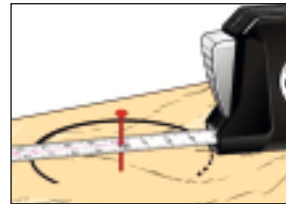

Use as a compass and draw precise arcs with a single hand.

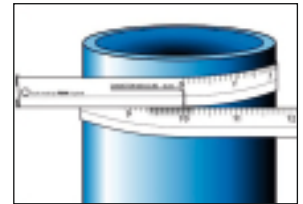

The stiff, yet flexible tape makes it easy to measure diameters and exact circumferences.

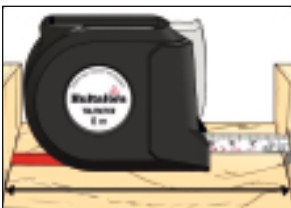

Measure internal lengths just as quickly and simply as external lengths.

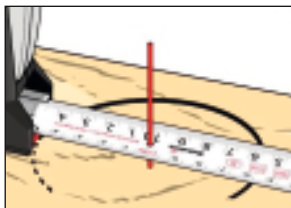

Use as a compass to draw precise arcs with a single hand.



The combined measurement and marking edges allow you to take your measurement and then transfer it to your workpiece using the same measurement edges.



Button with three functions:

1. Autolock position - tape can be adjusted in and out.
2. Release position - tape retracts into the housing and is easy to pull out.
3. Brake position - the tape is locked.



A notch on rear edge of the housing allows the attachment of a safety line.



Unique belt clip with a quick release function that allows the marking measure to be released with one hand.

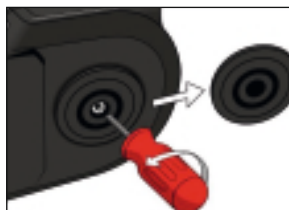

The belt clip attachment is easy to remove.

# Mitre Square.

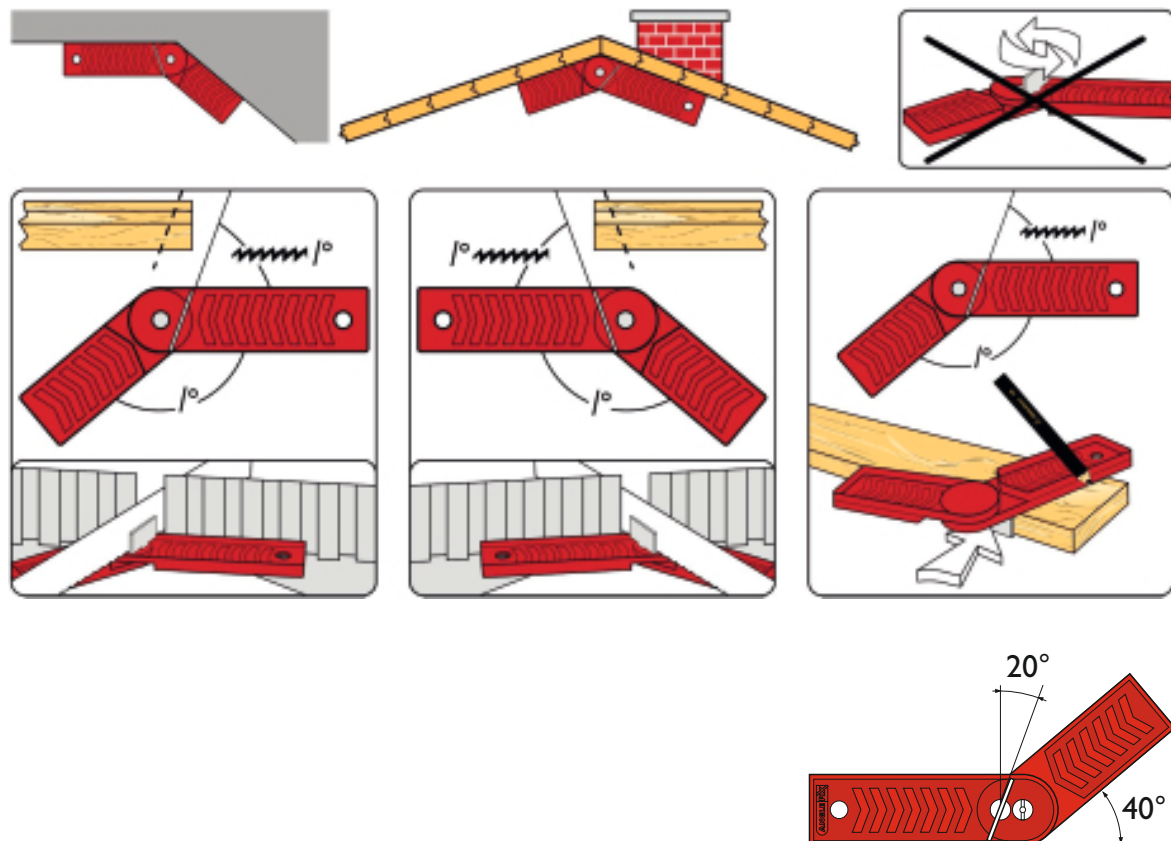

The mitre square helps you to easily identify the angle of an inner corner. Never adjust the square with the indicator flag as it might damage the tool. The mitre square can also be used for identifying the angle of wind disc. You get the angle of the two pieces by reading the indicator flag.

The square is ideal for cutting ceiling mouldings, both profiled and plain, even in sloped ceilings. It can also be used when calculating the angle of skirting boards in a corner. When cutting the material, just place it against the indicator flag. To mark the cutting angle of a piece of wood, turn the square upside down and place the indicator flag against the piece.

# Libella 2000.

## MULTI-FUNCTION SPIRIT LEVEL.

Libella 2000 is a short spirit level cast in aluminium with a smooth-finished contact surface. It is equipped with crush-proof block vials that have magnifying lenses and a luminescent reflector, which facilitates reading in environments that are not optimal. The radius of the vial is 1000 mm, giving a sensitivity of 2 mm/m. Tolerance in normal position is  $\pm 0.25$  mm, upside down  $\pm 0.75$  mm/m. Adding spirit level rails and gradient wedges will increase the number of applications your Libella 2000 can be used for.



1. When fitting door/window frames, Libella 2000 can be used with a spirit level rail.
2. Using a spirit level rail and extensions, the maximum length is increased to 3100 mm.

3. In narrow spaces, use Libella 2000 only.
4. You can check inclines using the gradient wedge.



# Nail puller Atle.

VERSATILE AND EASY-TO-USE.

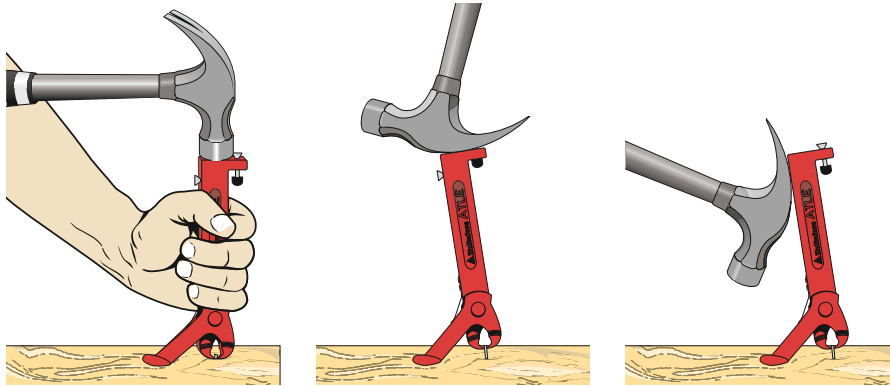

Atle is a versatile and easy-to-use nail puller that helps you pull out nails, even when the head is off or the nail is buried deep in the wood.

Atle is used together with your carpenter's hammer and to pull out the nail you just use the claw of your hammer.

# Holsters.

SAFE ATTACHMENT TO BOTH BELT AND BUTTON.

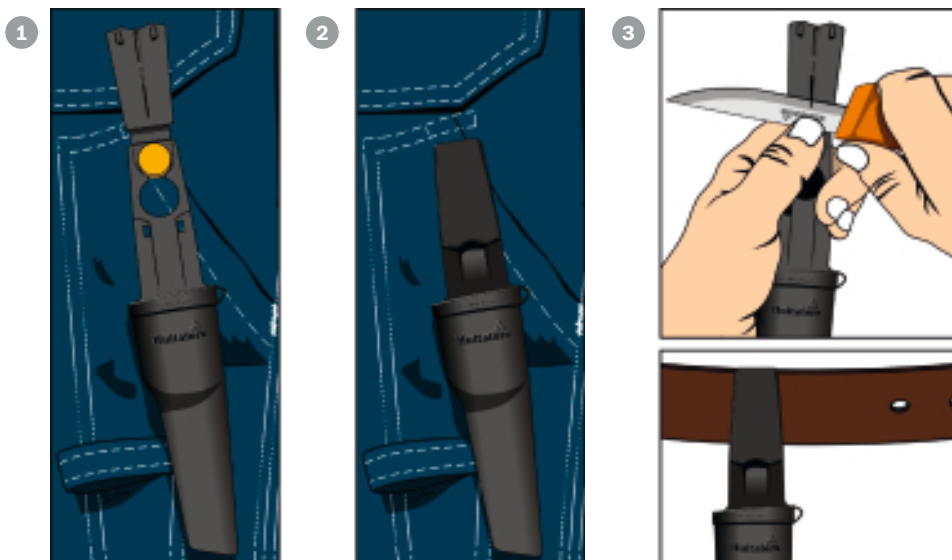

1. You simply attach the holster to a button on your trousers using a unique function that ensures that the holster doesn't come loose whilst still making it easy to remove.

2. Insert the button into the hole, pull the holster down and snap the cover firmly in position. To remove the holster, just undo the cover.

3. The holster can also be worn on a belt. If you have a thick belt, you may need to cut off the pin on the cover.





# Take care of your axe.

## Sharpen, store and use.

### SHARPENING.

Use a convex edge for applications such as delimiting, felling and splitting (1). Use a straight edge for hacking (2). An axe that has been sharpened at an angle is dangerous to use as it can easily slip! (3). A concave edge entails a high risk of the axe splintering (4). You can sharpen your axe edge using sandpaper or a bench grinder. The safest way to sharpen is using a wet grinder, but sometimes it may be necessary to first grind out burrs or other damage using a different method, e.g. a bench grinder.

### NB:

It is very important that you take care when sharpening and ensure that the axe is not affected by heat! If any part of the

axe turns a blue colour, it signals that its tempered zone has disappeared in that part of the axe and it is no longer as resistant to wear.

### STORAGE.

Never store your axe in excessively dry places, e.g. in boiler rooms or leaning against a heater. You then risk the shaft drying out and the axe head coming loose whilst being used.

### USE.

Never strike the neck of the axe with another tool. Never use the axe as a sledge. Only sledge axes can withstand being used as a sledge.

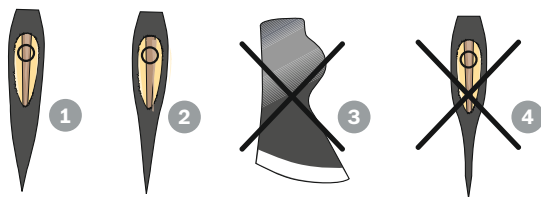

## Re-handle.

If an axe, sledge or hammer breaks, it is almost always the shaft/handle that is the culprit. A poor quality or damaged shaft is a major safety risk. However, if the head is still in good condition, you can re-use your tool by fitting a new shaft. When fitting a new shaft to your tool, it's important to ensure that the shaft is dry. If it's not and dries after the head as been fitted, there is a danger that the head will come loose. This also applies to the wedge if you fit a new shaft using a wooden wedge.

### SHAFT KEY

A = Ash  
S = Steel  
G = Fibreglass  
H = Hickory  
B = Beech

### MODEL DESIGNATION KEY

BHS 295 - 19 x 11  
↓                    ↓                    ↓  
Model   Length   Eye

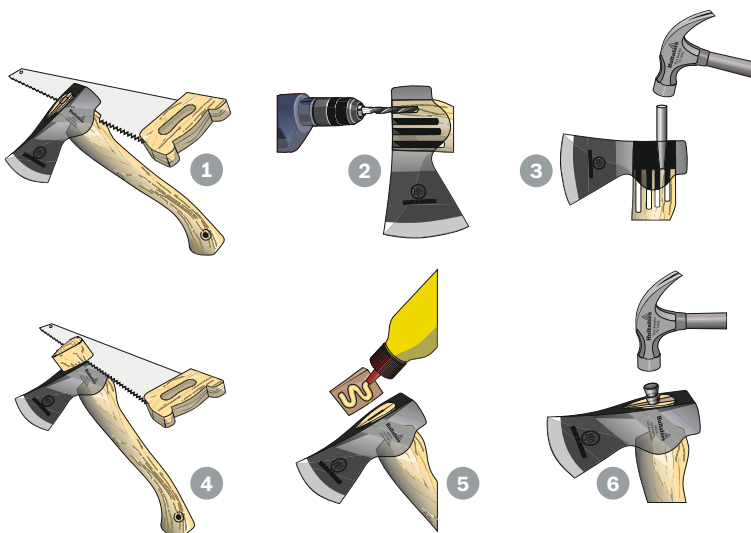

### TO FIT A NEW SHAFT, DO THE FOLLOWING:

1. Cut off the existing shaft just below the head.
2. Drill a number of holes in the eye.
3. Tap out what is left and clean the eye.
4. Press and tap the head onto the new shaft, firmly but carefully. Cut off the protruding part of the shaft.
5. Fit the steel wedge so that the end of the shaft fills the eye. If the steel wedge is not sufficient, you should fit a wooden wedge before the steel wedge. You can make this by cutting a wedge from a dry piece of hard timber. Then split the end of the shaft using a chisel. Apply some wood glue, tap in the wooden wedge and then cut off the excess.
6. Tap the steel wedge out so that it locks the wooden wedge in position. Then apply oil to the end of the shaft to protect it against moisture.





# Adjustable wrecking bar.



The adjustable wrecking bar in aluminium can be set in nine different positions. This gives you an optimal tool for demolishing, bending and adjusting. The wide, ground contact surfaces and thin ends make it easy to use and reduce the risk of leaving marks.

The adjustable wrecking bar is safe to work with and is considerably gentler on your body, particularly when working at shoulder height or above.



# A unique product family

HULTAFORS **GROUP** offers a dynamic range of premium brands to rely on – for distributors and craftsmen alike. Each brand within the Group is united with a common passion: to keep craftsmen at the forefront in terms of functionality, safety, protection and overall productivity.

Hultafors Groups is proud to present eight leading brands that together offer a unique product family for professional craftsmen.

Each brand represents expertise in its particular area and brings unparalleled knowledge and insight into the unique on-the-job challenges encountered by craftsmen. This makes it possible for us to meet, even anticipate, evolving demands by designing innovative state-of-the-art products that make the craftsmen's workday safer, easier and more productive.

Excelling in brand-driven product categories within the industry and construction equipment sectors, we offer customers and users a best-in-class experience. And by using our high-value products as well as benefitting from brands built around their needs, craftsmen can be at the forefront every day and take great pride in their work.



---

## HULTAFORS GROUP

# Hultafors Tools in Europe.

## HEAD OFFICE, SWEDEN

Box 38  
517 21 Bollebygd  
Tel. +46 (0)33 723 74 00  
Fax +46 (0)33 723 74 10  
info@hultaforsgroup.com

## AUSTRIA

Administered from the  
German national office.  
Im Meisenfeld 26  
32602 Vlotho  
Tel. +49 (0)5228 957 0  
Fax +49 (0)5228 957 112

## BELGIUM

Snickers Original NV  
Antwerpsessesteenweg 285  
2800 MECHELEN  
Tel. +32 (0)15 44 65 30  
Fax +32 (0)15 44 65 39

## CROATIA

Morlak d.o.o.  
Lindlarska 19  
21215 Kastel Luksic (Split)  
www.morlak-doo.hr  
Tel. +385 (0)21/228-245  
Fax +385 (0)21/261-210

## CZECH REPUBLIC AND SLOVAKIA

AC-T servis, spol. s r.o.  
Náchodská 61  
193 00 Praha 9  
Czech Republic  
Tel. 00420 281 926 244  
Fax 00420 281 926 244  
info@profi-odevy.cz  
www.profi-odevy.cz

## DENMARK

Hultafors Group Denmark A/S  
Energivej 37  
2750 Ballerup  
Tel. +45 44 86 06 00  
Fax +45 44 86 06 06

## ESTONIA

Tamrex Ohutuse OÜ  
Laki 5  
10621 Tallinn  
www.tamrex.ee  
Tel. +37 2 654 9900  
Fax +37 2 654 9901

## FINLAND

Hultafors Group Finland Oy  
Stella Business Park, talo Terra  
Lars Sonckin kaari 16  
02600 Espoo  
Tel. +358 (0)20 741 0130  
Fax +358 (0)20 741 0148

## FRANCE

Snickers Workwear France SARL  
59 Rue des Petits Champs  
75001 Paris  
Tel. +33 (0)1 53 40 89 90  
Fax +33 (0)1 53 40 89 89

## GERMANY

Hultafors Group Germany GmbH  
Im Meisenfeld 26  
32602 Vlotho  
Tel. +49 (0)5228 957 0  
Fax +49 (0)5228 957 112

## HUNGARY

KLÍMA-EXPRESS KFT  
Kereskedelmi és Szolgáltató Kft.  
H-1104. Budapest  
Bodza u. 2.  
www.munkaruha-munkacipo.hu  
Tel. +36 1 260 3950  
Tel. +36 1 260 4279  
Fax. +36 1 262 0758

## HUNGARY

Safety Systems Hungária Kft.  
SSH-SHOP  
H-1156 Budapest  
Szilas Park 10.  
www.sshshop.hu  
www.svedmunkaruha.hu  
Tel. +36 1 784 7079

## IRELAND

Snickers Workwear Ltd  
Unit B5, Calmount Park  
Ballymount  
DUBLIN 12  
Tel. +353 (0)1 409 8400  
Fax +353 (0)1 409 8499

## ITALY

**HULTAFORS GROUP ITALY SRL**  
Via Negrelli, 13  
39100 BOLZANO (BZ)  
info@hultaforsgroup.it  
Tel. +39 0471 061 666  
Fax. +39 0471 061 669

## LATVIA

SIA Tamrex  
Maskavas iela 328  
LV-1063 Riga  
www.tamrex.lv  
Tel. +371 660 65 265  
Fax +371 660 65 267

## LITHUANIA

UAB Tamrex  
Savanorių pr. 191  
LT-02300 Vilnius  
www.tamrex.lt  
Tel. +370 52671799  
Fax +370 52100040

## THE NETHERLANDS

Hultafors Group Netherlands BV  
Jean Monnetpark 81  
7336 BB APELDOORN  
Tel. +31 (0)55 599 98 60  
info@hultaforsgroup.nl  
www.hultafors.nl

## NORWAY

Hultafors Group Norge AS  
Postboks 108  
0582 OSLO  
Tel. +47 23 06 88 80  
Fax +47 22 16 49 80

## POLAND

Hultafors Group Poland Sp. z o.o.  
ul. Nowogrodzka 50/515  
00-695 Warszawa  
Tel. +48 22 29 51 287  
Fax +48 22 30 01 285

## PORTUGAL

Flexiwear, Lda  
Travessa de São Pedro, lote B  
2660-335 Stº António dos  
Cavaleiros  
www.flexiwear.com.pt  
Tel. +351 211 554 561  
Fax +351 211 305 520

## SLOVENIA

BMC d.o.o.  
Pod javorj 5  
1218 Komenda  
www.delovnaoblacila.si  
Tel. +386 183 13 156  
Fax +386 183 15 630

## SPAIN

AT - Snickers Workwear  
Labradores, 11  
Pol. Ind. Prado Espino  
28660 Boadilla del Monte,  
MADRID  
www.at-snickersworkwear.es  
Tel. +34 91 633 44 50  
Fax +34 91 632 07 15

## SWITZERLAND

Hultafors Group Switzerland AG  
Gaswerkstrasse 32  
CH-4900 Langenthal  
Tel. +41 (0)62 923 62 81  
(German)  
Tel. +41 (0)62 923 62 82  
(French)  
Fax +41 (0)62 923 62 85

## UK

Snickers Workwear Ltd  
Unit N3, Gate 4,  
Meltham Mills Ind Estate, Meltham  
HOLMFIRTH HD9 4DS  
Tel. +44 (0)1484 85 44 88  
Fax +44 (0)1484 85 47 33  
toolsinfo@snickersworkwear.co.uk

## USA

Sport Hansa LLC  
79 Dogwood road,  
Asheville N. Carolina 28806  
UNITED STATES

## OTHER MARKETS

Administered from Sweden  
Box 989  
191 29 SOLLENTUNA  
Tel. +46 (0)8 92 51 00  
Fax +46 (0)8 92 51 98  
info@hultafors.se

  
**Hultafors**

hultafors.com