



CATALOGUE 2022





MADE
FOR METAL.
MADE
FOR YOU.



Are you a professional working in metal, interior work or industrial screwdriving applications? If so, FEIN is the most reliable partner you will find, enabling you to deliver quality work on a daily basis and raise your productivity.

Like you, we are masters of our trade and our family-run business embodies the spirit of invention of our founder. Based on your requirements, we are finding better and better solutions, which combine man, tool and process to produce first-class power tool systems.

Together we are continually working to create added value for you: for over 150 years, we have been driven by delivering success for you in the long term, appreciation of your work and protection of your health – and will continue to do so in the future.

WE SHAPE THE FUTURE. FOR MORE THAN 150 YEARS.



80 % "Made in Germany" with production and development in Schwäbisch Gmünd, Germany.



A global and independent family-run business with German roots.



Ideal problem solvers for metalworking and interior work.

1867
Company founded by Wilhelm Emil Fein

1890

1895
The world's first power tool – the FEIN drill

1910

1925
The 100 000th tool is a FEIN hammer

1932

1933
Jigsaw for faster cutting for the automotive industry

1867 FOUNDED

850 EMPLOYEES
WORLDWIDE

1 COMPANY HEADQUARTERS IN
SCHWÄBISCH GMÜND

4 PRODUCTION SITES
DEU / USA / IND / CHN

700 ACTIVE
INDUSTRIAL PROPERTY RIGHTS

66 SITES
WORLDWIDE

500 PATENTS AND
PATENT APPLICATIONS

80 % "MADE IN GERMANY"
AT COMPANY HEADQUARTERS



Places great value on human interactions and scope for innovative ideas.



Provides numerous services to complement its products.



Suited to the toughest jobs in industry and manual trades.



1967



2009



FEIN

2019

1956



First drill with patented plastic half shell



The plaster cast saw was the first oscillating multi-tool

1985



Invention of the MULTIMASTER

1986



First angle grinder with brake

2013



The first 4-speed cordless drill/driver

2016



The Starlock interface becomes the new standard

2017



Cordless universal magnetic core drill

2018



Dust-resistant cordless angle grinder

YOU CAN RELY ON FEIN SERVICE.

With FEIN you're in good hands after making your purchase. We have designed our power tools for maximum loading and overload – even when used continuously. Should you ever need our help, we provide speedy, professional and dedicated assistance. That's something you can rely on.

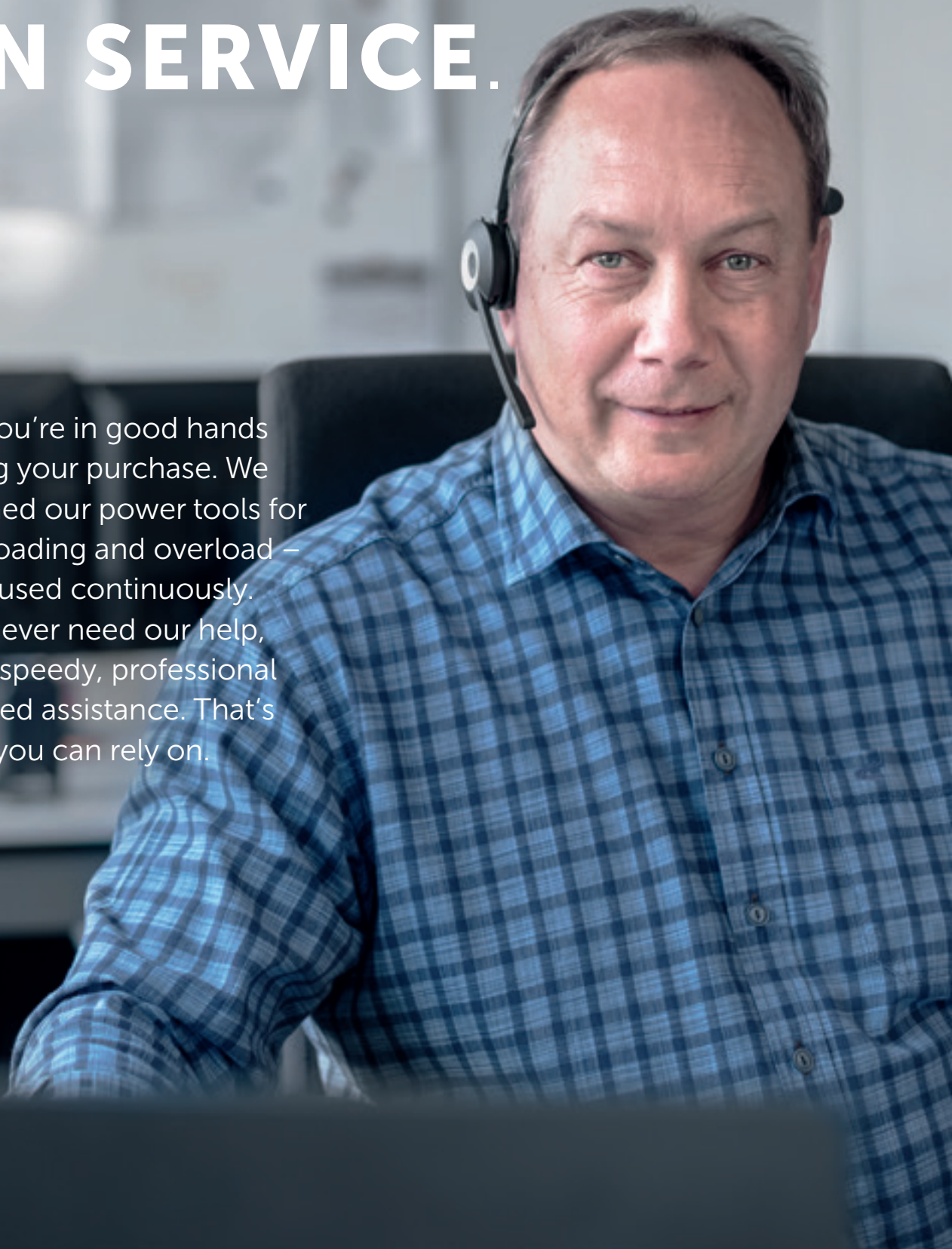

MY.FEIN APP AND ONLINE PORTAL

One log-in – and the FEIN world of service is at your fingertips. With my.FEIN, we make it easy for you to bundle services in one place and ensure that you always have them to hand. Either with the convenience of the app or online at **my.FEIN.com**

3-YEAR FEIN PLUS WARRANTY

Quick registration – extended warranty period: We offer the 3-year FEIN PLUS warranty for all your FEIN power tools. All you need to do is register your new FEIN product at **www.fein.com/warranty** within 3 months of purchase. Here you will find which countries are covered and further information.

FEIN REPAIR SERVICE

No matter whether you contact us regarding repairs, maintenance or warranty claims – we process your orders quickly and efficiently through our FEIN authorised repair centres. They hold the right genuine FEIN spare parts in stock – even for many older tools. So you can get back to work as soon as possible.

FEIN SPARE PART CATALOGUE

You can easily find the right FEIN spare parts for your FEIN power tool online – using the FEIN spare part catalogue with intuitive search function and exploded views of the products.

MORE FEIN SERVICES ONLINE

On our website, you will find lots more information and service offerings:

- + Operating instructions and brochures available to download
- + FAQ
- + Maintenance information

The website also contains details of services available locally to you.

THE FEIN CORDLESS WORLD MADE FOR METAL.

There are lots of cordless platforms. But only one which supplies the power for FEIN tools.

Welcome to the FEIN cordless world. It's packed full of robust technology with one major objective: to make the lives of our customers and users as simple and productive as possible. And to do this in the long-term. Whether grinding, screwdriving, drilling, core drilling, dividing, cutting or oscillating – FEIN offers a powerful and efficient cordless solution for every application. Enter this world today and be impressed for ever. For more information, go to: www.fein.com

FEIN cordless products for metal professionals.



COMPLETE POWER WITHOUT ANY CABLES.

Master the toughest applications free from cables: This is made possible through the perfect combination of motor, battery, gearbox and electronics. The long-life, powerful and precise cordless tools of FEIN quality make any work for professionals in the metalworking sector easier, more efficient and safer.

30 % HIGHER EFFICIENCY

The brushless FEIN PowerDrive motor operates at high speeds and without carbon brushes. So it is particularly efficient and almost free of wear. With 30 % more efficiency than conventional technology, tradesmen can work for twice as long per battery charge. The low power consumption results in an extended battery life.

FULLY ENCAPSULATED FOR COMPLETE DUST PROTECTION

FEIN's closed motor concept is the ideal solution for applications where high levels of dust are produced. A fully encapsulated PowerDrive motor on cordless angle grinders protects against ceramic and mineral swarf and thereby extends the service life. A low weight and innovative cooling ribs for optimum heating underline FEIN's technical supremacy.



LONG SERVICE LIFE

The SafetyCell Technology protects tool and battery from overload, overheating and total discharge. The separate communication cable between both components shuts down the tool if overloaded. When charging, individual cell monitoring prevents the battery from being overcharged.

COMPLETE FLEXIBILITY. GREAT ENDURANCE.



100 % COMPATIBILITY

between FEIN Li-ion battery, tool and charger. The batteries are compact, robust and can handle extreme loads. The charge state is shown directly on the battery. FEIN SafetyCell Technology ensures a long service life.

EVEN MORE FREEDOM

Most 18 V products come with the FEIN MultiVolt interface and can also be operated with 12 V batteries, allowing users to put together any combination of battery and tool they want. Cordless products achieve maximum performance with 18 V. When using batteries with a lower voltage, the performance changes accordingly.

75 % MORE OUTPUT

The FEIN HighPower batteries are powerful and light weight products with cells capable of handling high currents for consistently rapid work progress and high speed stability. The compact power packs deliver 75 % more output than comparable batteries – at a weight of just 750 g. Their internal resistance is 25 % lower so less heat is produced.

Important information: Cordless angle grinders, cordless trimmers and cordless core drills only achieve maximum performance with 18 V / 5.2 Ah FEIN HighPower batteries.

CHARGE AT SPEED AND GENTLY.

Large LED display

with charge indicator
for complete monitoring
of the battery charge state.



USB port

for mobile charging
of additional devices,
for example smart-
phones.

MAXIMUM CHARGE CURRENT UP TO 80 % CAPACITY

The ALG 80 (BC) rapid charger allows FEIN batteries to be charged both quickly and gently with a high charge current of 8 A following the CCCV (Constant Current Constant Voltage) charging method. First, the batteries are charged up to 80 % of capacity at the maximum charge current and then up to 100 % at a constant voltage and lower charge current. This prevents them from being overcharged and thereby preserves the batteries for an even longer service life.

12 and 18 V / 3 Ah

31 min



12 and 18 V / 6 Ah

38 min



18 V / 5.2 Ah

33 min



80 % of maximum capacity

EVEN MORE BENEFITS WITH THE BLUETOOTH® ALG 80 BC CHARGER AND MY.FEIN APP

Using Bluetooth® connectivity, the ALG 80 BC charger can be combined with a smartphone or tablet. If using the my.FEIN app, the charger communicates information about the battery connected to the mobile end device.

my.FEIN app & online portal

ALL OUR SERVICES IN ONE PLACE: **YOUR PLACE.**

One log-in – and the FEIN world of service is at your fingertips.

With my.FEIN, we make it easy for you to bundle services in one place and ensure that you always have them to hand. Either with the convenience of the **app** or online at **my.fein.com**.



In the future, it will be possible for more and more FEIN devices to be networked with my.FEIN. The first such device is the new ALG 80 BC Bluetooth® rapid charger.





FEIN BENEFITS

+ Simple tool management

- + All registered FEIN tools at a glance.
- + Tools are identified using individual inventory numbers.
- + One common customer account for all users in your company.

+ Simple registration process for the 3-year FEIN PLUS warranty

- + Rapid registration using the type plate scanner.
- + Digital storage of sales receipts and warranty certificates.

+ Networking with the ALG 80 BC Bluetooth® rapid charger

- + Read off battery charge cycles to date.
- + View current charge status.
- + Push notification of fully-charged battery.

Download the my.FEIN app now –
it's free of course



Google Play and the Google-Play logo are trademarks of Google LLC.
Apple and the Apple logo are trademarks of Apple Inc.

CLEVERLY COMBINED WITH SELECT

**1. CHOOSE
FEIN SELECT
TOOL**



**2. FLEXIBLY
COMBINE FEIN
BATTERY AND
CHARGER**



Flexibly combine tool, batteries and charger to suit your needs – and only ever buy just what you need.



18 V

**4-speed cordless drill/driver
ASCM 18 QM Select**

No-load speed
400 / 800 / 1,950 / 3,850 rpm
(Page 43)



18 V

**4-speed cordless drill/driver
ASCM 18 QSW Select**

No-load speed
400 / 700 / 1,400 / 2,500 rpm
(Page 43)



18 V

**2-speed cordless drill/driver
ABS 18 Q Select**

No-load speed 450 / 2,000 rpm
(Page 44)



18 V

**2-speed cordless hammer
drill/driver
ASB 18 Q Select**

No-load speed 450 / 2,000 rpm
(Page 44)



18 V

**Cordless rotary hammer drill
ABH 18 Select**

Impact energy 2 J
(Page 31)



18 V

**Cordless impact wrench/driver
ASCD 18-1000 W34 Select**

Maximum torque of 1,050 Nm
(Page 51)



18 V

**Cordless impact wrench/driver
ASCD 18-300 W2 Select**

Maximum torque of 290 Nm
(Page 51)



18 V

**Cordless impact wrench/driver
ASCD 18-200 W4 Select**

Maximum torque of 210 Nm
(Page 51)



18 V	18 V	18 V	18 V
Cordless metal screw gun ASCS 6.3 Select	Cordless autofeed screwdriver ASCT 18 M Select	Cordless drywall screw gun ASCT 18 Select	2-speed cordless drill ABOP 13-2 Select
No-load speed 1,700 rpm (Page 60)	No-load speed 4,000 rpm (Page 63)	No-load speed 4,000 rpm (Page 63)	Hole diameter in steel 13 mm (Page 22)



18 V	18 V	18 V	18 V
Cordless angle drill AWBP 10 Select	Cordless thread drill AGWP 10 Select	Cordless core drill AKBU 35 PMQ Select	Cordless core drill AKBU 35 PMQW Select
Hole diameter in steel 10 mm (Page 32)	Thread in steel up to M10 (Page 34)	Core drill bit max. diameter 35 mm QuickIN (Page 167)	Core drill bit max. diameter 35 mm 3/4" Weldon (Page 167)



18 V	18 V	18 V	18 V
Cordless angle grinder CCG 18-125 BL Select	Cordless angle grinder CCG 18-125 BLPD Select	Cordless angle grinder CCG 18-115 BL Select	Cordless angle grinder CCG 18-115 BLPD Select
Grinding disc diameter of 125 mm Slide switch (Page 69)	Grinding disc diameter of 125 mm "AutoStop" dead man's switch (Page 70)	Grinding disc diameter of 115 mm Slide switch (Page 69)	Grinding disc diameter of 115 mm "AutoStop" dead man's switch (Page 70)



18 V	18 V
Cordless die grinder AGSZ 18-280 BL Select	Cordless die grinder AGSZ 18-280 LBL Select
No-load speed 9,000–28,000 rpm (Page 94)	No-load speed 9,000–28,000 rpm (Page 94)



18 V

**Cordless die grinder
AGSZ 18-90 LBL Select**

No-load speed 2,900–9,000 rpm
(Page 94)



18 V

**Cordless trimmer
AKFH 18-5 Select**

Chamfer length up to 5 mm
(Page 147)



18 V

**Cordless nibbler
ABLK 18 1.6 E Select**

Material thickness up to 1.6 mm
(Page 129)



18 V

**Cordless nibbler
ABLK 18 1.3 CSE Select**

Corrugated sheet metal up to material
thickness of 1.3 mm
(Page 128)



18 V

**Cordless nibbler
ABLK 18 1.3 TE Select**

Trapezoid sheet metal up to material
thickness of 1.3 mm
(Page 128)



18 V

**Cordless sheet metal shears
ABLK 18 1.6 E Select**

Material thickness up to 1.6 mm
(Page 123)



18 V

**Cordless slitting shears
ABS 18 1.6 E Select**

Material thickness up to 1.6 mm
(Page 119)



18 V

**Cordless MULTIMASTER
AMM 700 Max Select**

Amplitude 2 x 2.0°
(Page 225)



18 V

**Cordless MULTIMASTER
AMM 500 Plus Select**

Amplitude 2 x 1.7°
(Page 223)



12 V

**4-speed cordless drill/driver
ASCM 12 Q Select**

No-load speed
400/700/1,400/2,500 rpm
(Page 45)



12 V

**2-speed cordless drill/driver
ABSU 12 Select**

No-load speed 400 / 1300 rpm
(Page 46)



12 V

**2-speed cordless drill/driver
ABSU 12 W4 Select**

No-load speed 400 / 1,300 rpm
(Page 46)



12 V

**Cordless impact wrench/driver
ASCD 12-150 W8 Select**

Maximum torque of 135 Nm
(Page 52)



12 V

**Cordless impact wrench/driver
ASCD 12-150 W4 Select**

Maximum torque of 135 Nm
(Page 52)



12 V

**Cordless impact wrench/driver
ASCD 12-100 W4 Select**

Maximum torque of 100 Nm
(Page 52)



12 V

**Cordless MULTIMASTER
AMM 300 Plus Select**

Amplitude 2 x 1.6°
(Page 222)



18 V	18 V	18 V	18 V
Cordless 18 V / 3 Ah	Cordless 18 V / 6 Ah	HighPower battery 18 V / 5.2 Ah	Rapid charger ALG 80 BC
Weight 0.45 kg (Page 120)	Weight 0.70 kg (Page 120)	Weight 0.75 kg (Page 148)	8 A charge current with Bluetooth® (Page 120)



18 V	18 V	18 V	12 V
Battery starter set 18 V / 3 Ah	Battery starter set 18 V / 6 Ah	HighPower battery starter set 18 V / 5.2 Ah	Cordless 12 V / 3 Ah
2 batteries with ALG 80 BC rapid charger (Page 121)	2 batteries with ALG 80 BC rapid charger (Page 121)	2 HighPower batteries with ALG 80 BC rapid charger (Page 148)	Weight 0.25 kg (Page 239)



12 V	12 V	12 V	12 V
Cordless 12 V / 6 Ah	Rapid charger ALG 80	Battery starter set 12 V / 3 Ah	Battery starter set 12 V / 6 Ah
Weight 0.45 kg (Page 239)	8 A charge current (Page 239)	2 batteries with ALG 80 rapid charger (Page 239)	2 batteries with ALG 80 rapid charger (Page 239)



Accessory	Accessory
Cordless ALED 12-18 V LED lamp	AUSB 12-18 V cordless USB adapter
Brightness of 900 Lux (Page 120)	2 x 1.2 A charge connection (Page 120)

MORE THAN 4 500 ACCESSORIES FOR YOUR TASKS.

For more than 150 years, the range of FEIN accessories has grown to meet your changing requirements – perfectly matched to our tools and your particular applications. From sawing, sanding, dividing and polishing to drilling and screwdriving.



DRILLING **18**

Drills	20	Tappers	34
Rotary hammer drill	31	Magnetic drill jigs	36
Angle drills	32		

FASTENING **40**

Drill/Driver	42	AccuTec baton offset screwdriver	56
Cordless impact wrench/driver	50	Metal screw gun	60
AccuTec screw guns with mid-mounted handle	55	Dry wall screw guns	62

GRINDING **66**

Cordless angle grinder	68	Die Grinders	92
Compact angle grinders	71	HF-angle grinder	100
Long-necked angle grinder	83	High Frequency Straight Grinders	106
Angle Grinders	84	Frequency converter	111

SHEET METAL WORKING **116**

Slitting shears	118	Nibblers	126
Sheet metal shears	122		

SAWING AND CUTTING **136**

Jigsaws	138	Beveller	146
Pipe Saws	141	Pipe milling machine	152
Chop saws	145		

METAL CORE DRILLING **154**

Economical	156	Universal	164
Compact	159	Automatic	174

WET / DRY DUST EXTRACTOR **188**

Wet / dry dust extractor	190
--------------------------	-----

SURFACE PROCESSING **198**

Sanders	200	Polishers	211
---------	-----	-----------	-----

OSCILLATING MULTI-TOOL **218**

MULTIMASTER	220	12-sided fitting accessories	241
Starlock accessories	227	MULTIMASTER Automotive	246

BELT GRINDERS **254**

GRIT GHB hand-guided belt grinder	256	GRIT GI basic belt grinder for industry	262
GRIT GX basic belt grinder for manual trades	259	GRIT GI add-on modules for industry	265
GRIT GX add-on modules for manual trades	261	GRIT GKS compact belt grinder	270

ACCESSORIES **280**

Balancers	282
-----------	-----

ACCESSORIES, NUMERICAL PART

Machines in numerical order	285	Vibration and noise emission values	337
Accessories in numerical order	291		





DRILLING

DRILLS **20**

Perfectly suited to the job. Precise, powerful, easy to use.

ROTARY HAMMER DRILL **31**

Unbeatable in stone, concrete and masonry.
Universal suitability for a very wide range of applications.

ANGLE DRILLS **32**

Makes easy work of drilling round corners.
Compact, versatile and powerful, for difficult
or narrow locations.

TAPPERS **34**

Efficient, precise and reliable. The alternative
to working by hand.

MAGNETIC DRILL JIGS **36**

Horizontal, vertical or overhead working:
easy to use and flexible, on site or in the workshop.



	ABOP 13-2 SELECT	BOP 6	BOP 10	BOP 10-2
	Universal two-speed drill (battery-powered), up to 13 mm with ideal speed range for steel and stainless steel.	Fast-running single-speed drill with good speed stability, up to 6 mm in steel in metal construction.	Compact single-speed drill with speed stability, up to 10 mm in steel for on-site installation work.	Universal two-speed drill, up to 10 mm with ideal speed range for steel and stainless steel.
PAGE	22	23	24	25
Twist drilling	++		++	++
Tapping	++		+	++
Sawing holes in sheet metal				
Countersinking	++		+	++
Reaming				
Reversible rotation	•	•	•	•
Acceleration electronics	•	•	•	•
Torque slipping clutch				
Speed preselection				
Input	W		500	500
Output	W		270	270
Battery voltage	V	18		
Battery compatibility		Li-ion/ HighPower Li-ion		
Battery interface		18 V		
Speed, full load	rpm	0 - 500 / 0 - 1,500	0 - 2,700	0 - 900
Speed, no load	rpm	0 - 580 / 0 - 1,760	0 - 4,000	0 - 1,500
Torque at max. output power	Nm	24 / 8	3,5	9
Stall torque	Nm	39 / 13	9	24
Drill chuck clamping width	mm	1.5 - 13	0.5 - 10	1.5 - 13
Capacity in steel Ø	mm	13	6	10
capacity in Ø stainless steel	mm	13	6	10
Capacity in alu Ø	mm	16	10	15
Capacity in wood Ø	mm	37	20	30
Drilling diameter in steel, hole saws	mm			
Tapping		M 10		M 6
Countersinking max. Ø	mm			
Thread of spindle		1/2"-20 UNF	1/2"-20 UNF	1/2"-20 UNF
Collar Ø	mm	43	43	43
Width across corners	mm	23	23	23
Cable with plug	m		5	5
Weight according to EPTA	kg		1,7	1,8
Weight without storage battery	kg	1,7		2

+ suitability ++ optimal suitability • included ** Torque slipping clutch.

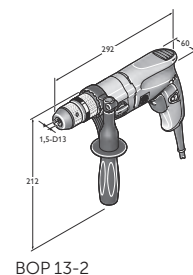
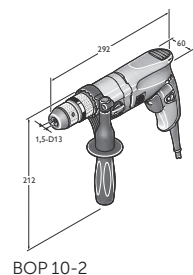
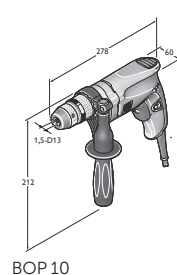
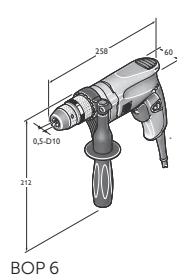
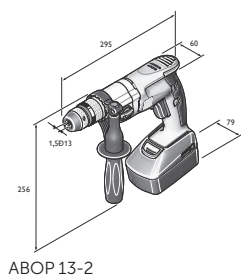



BOP 13-2	BOS 16	BOS 16-2	BOZ 32-4 M
Universal two-speed drill, up to 13 mm with ideal speed range for steel and stainless steel.	Powerful drill with speed setting for flexible use in metal construction.	Powerful two-speed drill with speed setting for flexible use in metal construction.	Universal four-speed drill with forward/reverse running, speed setting, MT3 tool mounting for heavy-duty drilling.
26	27	27	28
++	++	++	++
++	++	++	++
	+	+	+
++	++	++	++
	+	+	++
•	•	•	•
•	•	•	•
	•	•	•
	•	•	•
550	1,200	1,200	1,800
300	680	680	1,100
0 - 440 / 0 - 1,300	0 - 520	0 - 520 / 0 - 1,600	
0 - 680 / 0 - 2,200	0 - 520	0 - 520 / 0 - 1,600	
20 / 7	50	50 / 16	75 / 48 / 34 / 22
50 / 16	50 **	50 / 16 **	75 / 48 / 34 / 22 **
1.5 - 13	3 - 16	3 - 16	
13	16	16	32
13	16	16	20
16	20	20	60
37	50	50	70
	80	80	
M 10	M 12	M 12	M 24
	31	31	50
1/2"-20 UNF	1/2"-20 UNF	1/2"-20 UNF	
43			65
23	27	27	38
5	4	4	3,1
2	3,5	3,7	7,5

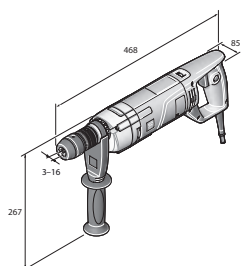

BOS 16

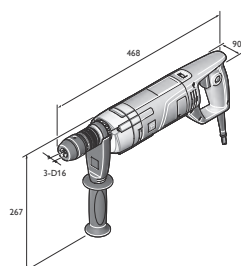

BOS 16-2

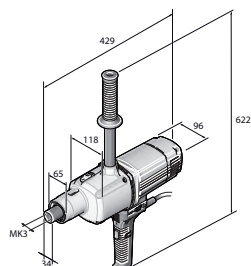

BOZ 32-4 M

ABOP 13-2 SELECT**SUPPLIED**

1 SUPRA SKE single sheath metal quick clamping drill chuck,
1 additional handle, 1 plastic carrying case

For accessories, see page 29

Universal two-speed drill (battery-powered), up to 13 mm with ideal speed range for steel and stainless steel.

Battery voltage	V	18
Battery compatibility		Li-ion/ HighPower Li-ion
Battery interface		18 V
Speed, full load	rpm	0 - 500 / 0 - 1,500
Speed, no load	rpm	0 - 580 / 0 - 1,760
Torque at max. output power	Nm	24 / 8
Stall torque	Nm	39 / 13
Drill chuck clamping width	mm	1.5 - 13
Capacity in steel Ø	mm	13
capacity in Ø stainless steel	mm	13
Capacity in alu Ø	mm	16
Capacity in wood Ø	mm	37
Tapping		M 10
Thread of spindle		1/2"-20 UNF
Collar Ø	mm	43
Width across corners	mm	23
Weight without storage battery	kg	1,7

Part number	7 105 03 62 00 0
EAN	4014586881768

FEIN BENEFITS

- + Mechanical two-speed gearbox for optimum speed adjustment for a wide range of uses.
- + Outstanding quality battery-powered drill with high concentricity for precise drilling results.
- + Brushless FEIN PowerDrive motor, fully encapsulated and dust-protected with 30 % higher efficiency and long service life.
- + Reversible.
- + Metal gear head.
- + High-precision metal drill chuck.
- + High concentricity.
- + Self-tightening drill chuck clamping jaws.
- + Automatic spindle locking and single sheath quick clamping drill chuck.
- + FEIN Sensitive Handle.
- + Variable speed control.
- + 43 mm diameter collar for use in the drill jig.
- + FEIN SafetyCell technology. Protects the battery and tool from overload, overheating and total discharge.

BOP 6**BOP 6 SET**

Fast-running single-speed drill with good speed stability, up to 6 mm in steel in metal construction.

Input	W	500	500
Output	W	270	270
Speed, full load	rpm	0 - 2,700	0 - 2,700
Speed, no load	rpm	0 - 4,000	0 - 4,000
Torque at max. output power	Nm	3,5	3,5
Stall torque	Nm	9	9
Drill chuck clamping width	mm	0.5 - 10	0.5 - 10
Capacity in steel Ø	mm	6	6
capacity in Ø stainless steel	mm	6	6
Capacity in alu Ø	mm	10	10
Capacity in wood Ø	mm	20	20
Thread of spindle		1/2"-20 UNF	1/2"-20 UNF
Collar Ø	mm	43	43
Width across corners	mm	23	23
Cable with plug	m	5	5
Weight according to EPTA	kg	1,7	1,7

FEIN BENEFITS

- + Optimum speed for lower diameters and therefore economic working with efficient use of the machine.
- + FEIN high-power motor with good speed stability for constant drilling progress in almost any application.
- + Metal gear head and distortion-free barrel-type motor housing for superb service life.
- + Reversible.
- + High-precision metal drill chuck.
- + High concentricity.
- + Self-tightening drill chuck clamping jaws.
- + FEIN Sensitive Handle.
- + Variable speed control.
- + 5 metre cable.
- + 43 mm diameter collar for use in the drill jig.

SUPPLIED

1 SUPRA SKE single sheath metal quick clamping drill chuck,
1 additional handle

1 SUPRA SKE single sheath metal quick clamping drill chuck,
1 additional handle, 1 plastic carrying case

Part number	7 205 52 60 00 0	7 205 52 61 00 0
EAN	4014586882413	4014586881973

For accessories, see page 29

BOP 10**BOP 10 SET**

Compact single-speed drill with speed stability, up to 10 mm in steel for on-site installation work.

Input	W	500	500
Output	W	270	270
Speed, full load	rpm	0 - 900	0 - 900
Speed, no load	rpm	0 - 1,500	0 - 1,500
Torque at max. output power	Nm	9	9
Stall torque	Nm	24	24
Drill chuck clamping width	mm	1.5 - 13	1.5 - 13
Capacity in steel Ø	mm	10	10
capacity in Ø stainless steel	mm	10	10
Capacity in alu Ø	mm	15	15
Capacity in wood Ø	mm	30	30
Tapping		M 6	M 6
Thread of spindle		1/2"-20 UNF	1/2"-20 UNF
Collar Ø	mm	43	43
Width across corners	mm	23	23
Cable with plug	m	5	5
Weight according to EPTA	kg	1,8	1,8

FEIN BENEFITS

- + Particularly flat and slim design with excellent width across corners for installation work even in tight spaces and corners.
- + FEIN high-power motor with good speed stability for constant drilling progress in almost any application.
- + Metal gear head and distortion-free barrel-type motor housing for superb service life.
- + Reversible.
- + High-precision metal drill chuck.
- + High concentricity.
- + Self-tightening drill chuck clamping jaws.
- + FEIN Sensitive Handle.
- + Variable speed control.
- + 5 metre cable.
- + 43 mm diameter collar for use in the drill jig.

SUPPLIED

1 SUPRA SKE single sheath metal quick clamping drill chuck,
1 additional handle

1 SUPRA SKE single sheath metal quick clamping drill chuck,
1 additional handle, 1 plastic carrying case

Part number	7 205 53 60 00 0	7 205 53 61 00 0
EAN	4014586882468	4014586881980

For accessories, see page 29

BOP 10-2**BOP 10-2 SET**

Universal two-speed drill, up to 10 mm with ideal speed range for steel and stainless steel.

Input	W	500	500
Output	W	270	270
Speed, full load	rpm	0 - 460 / 0 - 1,350	0 - 460 / 0 - 1,350
Speed, no load	rpm	0 - 700 / 0 - 2,250	0 - 700 / 0 - 2,250
Torque at max. output power	Nm	20 / 7	20 / 7
Stall torque	Nm	50 / 16	50 / 16
Drill chuck clamping width	mm	1.5 - 13	1.5 - 13
Capacity in steel Ø	mm	10	10
capacity in Ø stainless steel	mm	10	10
Capacity in alu Ø	mm	16	16
Capacity in wood Ø	mm	35	35
Tapping		M 10	M 10
Thread of spindle		1/2"-20 UNF	1/2"-20 UNF
Collar Ø	mm	43	43
Width across corners	mm	23	23
Cable with plug	m	5	5
Weight according to EPTA	kg	2	2

FEIN BENEFITS

- + Mechanical two-speed gearbox for optimum speed adjustment for a wide range of uses.
- + FEIN high-power motor with good speed stability for constant drilling progress in almost any application.
- + Metal gear head and distortion-free barrel-type motor housing for superb service life.
- + Reversible.
- + High-precision metal drill chuck.
- + High concentricity.
- + Self-tightening drill chuck clamping jaws.
- + FEIN Sensitive Handle.
- + Variable speed control.
- + 5 metre cable.
- + 43 mm diameter collar for use in the drill jig.

SUPPLIED

1 SUPRA SKE single sheath metal quick clamping drill chuck, 1 additional handle	1 SUPRA SKE single sheath metal quick clamping drill chuck, 1 additional handle, 1 plastic carrying case
------------------------------------------------------------------------------------	-------------------------------------------------------------------------------------------------------------

Part number	7 205 54 60 00 0	7 205 54 61 00 0
EAN	4014586882512	4014586881997

For accessories, see page 29

BOP 13-2**BOP 13-2 SET**

Universal two-speed drill, up to 13 mm with ideal speed range for steel and stainless steel.

Input	W	550	550
Output	W	300	300
Speed, full load	rpm	0 - 440 / 0 - 1,300	0 - 440 / 0 - 1,300
Speed, no load	rpm	0 - 680 / 0 - 2,200	0 - 680 / 0 - 2,200
Torque at max. output power	Nm	20 / 7	20 / 7
Stall torque	Nm	50 / 16	50 / 16
Drill chuck clamping width	mm	1.5 - 13	1.5 - 13
Capacity in steel Ø	mm	13	13
capacity in Ø stainless steel	mm	13	13
Capacity in alu Ø	mm	16	16
Capacity in wood Ø	mm	37	37
Tapping		M 10	M 10
Thread of spindle		1/2"-20 UNF	1/2"-20 UNF
Collar Ø	mm	43	43
Width across corners	mm	23	23
Cable with plug	m	5	5
Weight according to EPTA	kg	2	2

FEIN BENEFITS

- + Mechanical two-speed gearbox for optimum speed adjustment for a wide range of uses.
- + FEIN high-power motor with good speed stability for constant drilling progress in almost any application.
- + Metal gear head and distortion-free barrel-type motor housing for superb service life.
- + Reversible.
- + High-precision metal drill chuck.
- + High concentricity.
- + Self-tightening drill chuck clamping jaws.
- + FEIN Sensitive Handle.
- + Variable speed control.
- + 5 metre cable.
- + 43 mm diameter collar for use in the drill jig.

SUPPLIED

1 SUPRA SKE single sheath metal quick clamping drill chuck,
1 additional handle

1 SUPRA SKE single sheath metal quick clamping drill chuck,
1 additional handle, 1 plastic carrying case

Part number	7 205 55 60 00 0	7 205 55 61 00 0
EAN	4014586882567	4014586882017

For accessories, see page 29

BOS 16

Powerful drill with speed setting for flexible use in metal construction.

BOS 16-2

Powerful two-speed drill with speed setting for flexible use in metal construction.

Input	W	1 200	1 200
Output	W	680	680
Speed, full load	rpm	0 - 520	0 - 520 / 0 - 1,600
Speed, no load	rpm	0 - 520	0 - 520 / 0 - 1,600
Torque at max. output power	Nm	50	50 / 16
Stall torque	Nm	50 **	50 / 16 **
Drill chuck clamping width	mm	3 - 16	3 - 16
Capacity in steel Ø	mm	16	16
capacity in Ø stainless steel	mm	16	16
Capacity in alu Ø	mm	20	20
Capacity in wood Ø	mm	50	50
Drilling diameter in steel, hole saws	mm	80	80
Tapping		M 12	M 12
Countersinking max. Ø	mm	31	31
Thread of spindle		1/2"-20 UNF	1/2"-20 UNF
Width across corners	mm	27	27
Cable with plug	m	4	4
Weight according to EPTA	kg	3,5	3,7

FEIN BENEFITS

- + Optimum speed for large diameters and therefore cost-effective working with efficient use of the tool.
- + FEIN high-power motor with good speed stability for constant drilling progress in almost any application.
- + Metal gear head and distortion-free barrel-type motor housing for superb service life.
- + Forward/reverse running and electronic speed preselection.
- + Speed-controlled tacho electronics.
- + High-precision metal drill chuck.
- + High concentricity.
- + Self-tightening drill chuck clamping jaws.
- + Spade handle for optimum power transfer.
- + Variable speed control.
- ** Torque slipping clutch.

SUPPLIED

1 SUPRA SKE single sheath metal quick clamping drill chuck, 1 additional handle

Part number	7 205 47 60 00 0	7 205 49 60 00 0
EAN	4014586874463	4014586876443

For accessories, see page 29

BOZ 32-4 M**SUPPLIED**

1 additional handle, 1 drift key

For accessories, see page 29

Universal four-speed drill with forward/reverse running, speed setting, MT3 tool mounting for heavy-duty drilling.

Input	W	1 800
Output	W	1 100
Load speed in speed 1	rpm	60 - 140
Load speed in speed 2	rpm	95 - 220
Load speed in speed 3	rpm	135 - 310
Load speed in speed 4	rpm	210 - 480
Torque at max. output power	Nm	75 / 48 / 34 / 22
Idling speed in speed 1	rpm	60 - 140
Idling speed in speed 2	rpm	95 - 220
Idling speed in speed 3	rpm	135 - 310
Idling speed in speed 4	rpm	210 - 480
Stall torque	Nm	75 / 48 / 34 / 22 **
Capacity in steel Ø	mm	32
capacity in Ø stainless steel	mm	20
Capacity in alu Ø	mm	60
Capacity in wood Ø	mm	70
Tapping		M 24
Countersinking max. Ø	mm	50
Collar Ø	mm	65
Width across corners	mm	38
Cable with plug	m	3,1
Weight according to EPTA	kg	7,5

Part number	7 202 51 60 00 0
EAN	4014586889849

FEIN BENEFITS

- + FEIN 1800 W high-power motor and mechanical 4-speed gearbox for high torque in heavy-duty drilling work.
 - + Tool with forward/reverse running and electronic speed reduction for all drilling work, such as twist drilling, tap drilling, countersinking and reaming.
 - + Extremely durable design for tough use thanks to highest quality materials and workmanship.
 - + MT3 tool mounting.
 - + Electronic torque shut-off.
 - + Speed-controlled tacho electronics.
 - + Able to handle extreme loads.
 - + Metal gear head.
 - + Cross handle.
 - + For optimum use on FEIN magnetic drill jigs.
 - + Wide range of accessories.
- ** Torque slipping clutch.

ACCESSORIES FOR (A)BOP 6, (A)BOP 10, (A)BOP 10-2, (A)BOP 13-2



TOOL CASE

With case insert and plastic box
Plastic, inner dimensions: 470 x 275 x 116 mm

Part number
3 39 01 118 48 0



QUICK CHARGER ALG 80 BC

Bluetooth® connectivity for connecting to a mobile end device and for use with the my.FEIN app. Shows the current charge state and the number of charge cycles to date on your smartphone or tablet. Provides notification when the battery is fully charged. Short charge times thanks to high charge current of 8 amps and process-controlled charge management. Large LED display with charge indicator and USB port for mobile charging of small electrical devices. For all FEIN Li-ion batteries. Charge times (80 % of max. capacity): 12 and 18 V / 3 Ah: 31 min., 12 and 18 V / 6 Ah: 38 min., 18 V / 5.2 Ah: 33 min.

Part number
9 26 04 210 01 0



BATTERY PACK

Li-ion battery with charge status indicator and FEIN SafetyCell technology. Protects the battery and tool from overload, overheating and total discharge. Can be used with all FEIN 18 V cordless tools.

Current/Voltages V	Capacity Ah	Weight kg	Part number
18	6	0,7	9 26 04 175 02 0
18	3	0,45	9 26 04 182 02 0



BATTERY STARTER SET

2 x Li-ion batteries with ALG 80 BC rapid charger. Bluetooth® connectivity for connecting to a mobile end device and for use with the my.FEIN app. Shows the current charge state and the number of charge cycles to date on your smartphone or tablet. Provides notification when the battery is fully charged. Short charge times thanks to high charge current of 8 amps and process-controlled charge management. Large LED display with charge indicator and USB port for mobile charging of small electrical devices. For all FEIN Li-ion batteries. Charge times (80 % of max. capacity): 12 and 18 V / 3 Ah: 31 min., 12 and 18 V / 6 Ah: 38 min., 18 V / 5.2 Ah: 33 min.

Current/Voltages V	Capacity Ah	Part number
18	6	9 26 04 323 01 0
18	3	9 26 04 324 01 0



QUICK-ACTION CHUCKS

Single sheath metal SUPRA SKE quick clamping drill chuck with locking force safety device, drill chuck holder 1/2" - 20 UNF

Chuck opening mm	Part number
0.5 - 10	6 32 05 036 01 0



QUICK-ACTION CHUCKS

Single sheath metal SUPRA SKE quick clamping drill chuck with locking force safety device, drill chuck holder 1/2" - 20 UNF

Chuck opening mm	Part number
1.5-13	6 32 05 035 01 0

JAW SPANNER SW17

Part number
6 29 03 002 00 9

SUSPENSION DEVICE

for hooking onto a balancer vertical

Part number
3 02 32 046 00 8



SUSPENSION DEVICE

for hooking onto a balancer horizontal and vertical

Part number
3 21 25 050 00 7



DEPTH STOP

Part number
3 21 27 005 00 6



CUTTING PASTE

Lubricating agents for working on sheet metals.

Part number
3 21 32 020 12 9

ACCESSORIES FOR BOS 16, BOS 16-2



TOOL CASE

Plastic, inner dimensions: 470 x 275 x 116 mm

Part number
3 39 01 118 01 0



PADDLE

Length 600 mm, Ø 110 mm

Part number
6 39 02 002 01 3



QUICK-ACTION CHUCKS

Single sheath metal SUPRA SKE quick clamping drill chuck with locking force safety device, drill chuck holder 1/2" - 20 UNF

Chuck opening mm	Part number
3-16	6 32 05 038 01 0

QUICK-ACTION CHUCKS

Drill chuck holder 1/2" - 20 UNF form R tip

Chuck opening mm	Part number
1-13	6 32 05 033 01 0



KEY-TYPE DRILL CHUCKS

Drill chuck holder 1/2" - 20 UNF

Chuck opening mm	Part number
1-10	6 32 03 034 01 0
1.5-13	6 32 03 041 01 4

ACCESSORIES FOR BOZ 32-4 M, DSKE 672, DDSK 672-1, DDSK 672



QUICK-ACTION CHUCKS

Drill chuck holder B 16
form R tip

Chuck opening mm	Part number
3-16	6 32 04 025 00 3



QUICK-ACTION CHUCKS

Drill chuck holder B 16
R shaped tip with locking force safety device

Chuck opening mm	Part number
1-13	6 32 04 032 00 6



KEY-TYPE DRILL CHUCKS

Drill chuck holder B 16

Chuck opening mm	Part number
1.5-13	6 32 02 030 01 5
3-16	6 32 02 037 01 0



MORSE TAPER ARBORS

for drilling machines with morse taper arbor

Mount	Part number
MT 3/B 16	6 33 01 012 00 5
MT 3/B 22	6 33 01 014 00 7



REDUCING SLEEVES

for M.T. sockets

Part number
6 33 02 003 00 4



DRIFT KEYS

Mount	Length mm	Part number
MT 1/MT 2	140	6 33 05 003 00 3
MT 3/MT 4	190	6 33 05 004 00 1

ACCESSORIES FOR ASQ 672-1



MORSE TAPER ARBORS

For tools with Morse taper.

Mount	Part number
MT 4/B 22	6 33 01 016 00 4



REDUCING SLEEVES

for M.T. sockets

Mount	Part number
MT 4/MT 3	6 33 02 004 00 2

ABH 18 SELECT



SUPPLIED

1 handle, 1 depth stop,
1 plastic carrying case

For accessories, see page 31

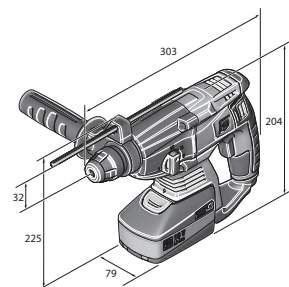

Extremely compact and powerful cordless rotary hammer drill with an impact energy of 2 J for drilling up to 20 mm in concrete.

Battery voltage	V	18
Battery compatibility		Li-ion/ HighPower Li-ion
Battery interface		18 V
Motor		brushless
Speed, no load	rpm	0 - 1,200
Impacts	rpm	0 - 4,400
Impact energy	J	2
Tool Holder		SDS-plus
Hole diameter, concrete	mm	20
Hole diameter, masonry	mm	68
Capacity in steel Ø	mm	13
Capacity in wood Ø	mm	22
Weight without storage battery	kg	2,3

FEIN BENEFITS

- + Rapid work progress thanks to brushless motor with high impact energy.
- + Fatigue-free working thanks to compact design and few vibrations.
- + Protection for the user and tool by means of safety clutch and overload protection.
- + Combination hammer with three functions: hammer drilling, drilling and chiselling.
- + Brushless motor with 30 % higher efficiency and long service life.
- + 100 screw connections (10 x 75 mm in concrete) with one battery charge (6 Ah).
- + Producing 68 mm socket holes with drill bit in masonry.
- + The optional drilling dust nozzle means that little dust is produced.
- + Low-vibration working at just 12 m/s².
- + FEIN SafetyCell technology. Protects the battery and tool from overload, overheating and total discharge.
- + The battery charge can be read off the battery.

Part number	7 140 01 64 00 0
EAN	4014586889214

GENERAL ACCESSORIES



CORDLESS ALED 12-18 V LED LAMP

Compact and durable cordless LED lamp with swivel-mounted lamp head. Compatible with all 12 / 14 / 18 V FEIN Li-ion batteries, including hook for attaching the lamp. Extremely lightweight at 130 g and very bright at 900 Lux. Colour temperature is the equivalent of daylight. The brightness can be set to 2 levels.

Part number

9 26 04 200 02 0



AUSB 12-18 V CORDLESS USB ADAPTER

Compact cordless USB adapter for charging smartphones, tablets etc. without a mains connection. 2 high-speed USB charging ports for rapid charging at 2x 1.2 amps. Suitable for iOS and Android. Compatible with all 12 / 14 / 18 V FEIN Li-ion batteries.

Part number

9 26 04 201 02 0



QUICK CHARGER ALG 80 BC

Bluetooth® connectivity for connecting to a mobile end device and for use with the my.FEIN app. Shows the current charge state and the number of charge cycles to date on your smartphone or tablet. Provides notification when the battery is fully charged. Short charge times thanks to high charge current of 8 amps and process-controlled charge management. Large LED display with charge indicator and USB port for mobile charging of small electrical devices. For all FEIN Li-ion batteries. Charge times (80 % of max. capacity): 12 and 18 V / 3 Ah: 31 min., 12 and 18 V / 6 Ah: 38 min., 18 V / 5.2 Ah: 33 min.

Part number

9 26 04 210 01 0



DRILLING DUST NOZZLE

Drilling dust nozzle for wet/dry dust extractor. For drilling in all standard wall and ceiling surfaces and producing little dust. For suction hose with 35 mm diameter.

Part number

9 26 02 101 01 0

18 V BATTERY



BATTERY PACK

Li-ion battery with charge status indicator and FEIN SafetyCell technology. Protects the battery and tool from overload, overheating and total discharge. Can be used with all FEIN 18 V cordless tools.

Current/Voltages	Capacity	Weight	Part number
V	Ah	kg	
18	6	0,7	9 26 04 175 02 0
18	3	0,45	9 26 04 182 02 0



BATTERY STARTER SET

2 x Li-ion batteries with ALG 80 BC rapid charger. Bluetooth® connectivity for connecting to a mobile end device and for use with the my.FEIN app. Shows the current charge state and the number of charge cycles to date on your smartphone or tablet. Provides notification when the battery is fully charged. Short charge times thanks to high charge current of 8 amps and process-controlled charge management. Large LED display with charge indicator and USB port for mobile charging of small electrical devices. For all FEIN Li-ion batteries. Charge times (80 % of max. capacity): 12 and 18 V / 3 Ah: 31 min., 12 and 18 V / 6 Ah: 38 min., 18 V / 5.2 Ah: 33 min.

Current/Voltages	Capacity	Part number
V	Ah	
18	6	9 26 04 323 01 0
18	3	9 26 04 324 01 0

AWBP 10 SELECT**SUPPLIED**

1 3-jaw chuck up to \varnothing 10 mm, 1 drill chuck key, 1 plastic carrying case

For accessories, see page 33

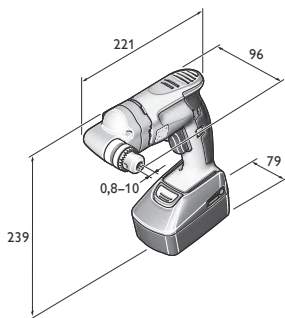

Extremely small cordless angle drill for working in difficult-to-reach spots.

Battery voltage	V	18
Battery compatibility		Li-ion/ HighPower Li-ion
Battery interface		18 V
Speed, full load	rpm	0 - 1,260
Speed, no load	rpm	0 - 1,370
Torque at max. output power	Nm	9,5
Stall torque	Nm	17
Drill chuck clamping width	mm	0.8 - 10
Capacity in steel \varnothing	mm	10
capacity in \varnothing stainless steel	mm	10
Capacity in alu \varnothing	mm	15
Capacity in wood \varnothing	mm	25
Tapping		M 6
Cone at drill shaft		B 10
Width across corners	mm	17
Gearbox head height		96
Weight without storage battery	kg	1,3

Part number	7 105 04 62 00 0
EAN	4014586881775

FEIN BENEFITS

- + Brushless FEIN PowerDrive motor, fully encapsulated and dust-protected with 30 % higher efficiency and long service life.
- + Particularly flat and slim design with 17 mm width across corners and 96 mm gearbox head height for work in tight spaces and corners.
- + Flexible and universal use thanks to clockwise and reverse running for thread cuts up to M6.
- + Metal gear head.
- + Tapered drill shaft.
- + High-precision metal drill chuck.
- + High concentricity.
- + FEIN Sensitive Handle.
- + FEIN SafetyCell technology. Protects the battery and tool from overload, overheating and total discharge.

WBP 10**SUPPLIED**

1 3-jaw chuck up to \varnothing 10 mm, 1 drill chuck key

For accessories, see page 33

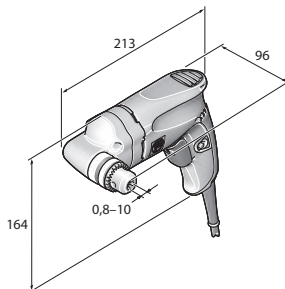

Extremely small angle drill for working in difficult-to-reach spots.

Input	W	500
Output	W	270
Speed, full load	rpm	0 - 1,030
Speed, no load	rpm	0 - 1,830
Torque at max. output power	Nm	8
Stall torque	Nm	21
Drill chuck clamping width	mm	0.8 - 10
Capacity in steel \varnothing	mm	10
capacity in \varnothing stainless steel	mm	10
Capacity in alu \varnothing	mm	15
Capacity in wood \varnothing	mm	25
Tapping		M 6
Cone at drill shaft		B 10
Width across corners	mm	17
Gearbox head height		96
Cable with plug	m	5
Weight according to EPTA	kg	1,5

Part number	7 205 51 60 00 0
EAN	4014586878843

FEIN BENEFITS

- + FEIN high-power motor with good speed stability for constant drilling progress in almost any application.
- + Particularly flat and slim design with 17 mm width across corners and 96 mm gearbox head height for work in tight spaces and corners.
- + Flexible and universal use thanks to clockwise and reverse running for thread cuts up to M6.
- + Metal gear head.
- + Tapered drill shaft.
- + High-precision metal drill chuck.
- + High concentricity.
- + Distortion-free barrel-type motor housing.
- + FEIN Sensitive Handle.
- + 5 metre cable.

GENERAL ACCESSORIES



KEY-TYPE DRILL CHUCKS
Drill chuck holder B 10

Chuck opening mm	Part number
0.8-10	6 32 02 044 01 8
0.5-8	6 32 02 043 01 0

ACCESSORIES FOR AWBP 10



TOOL CASE
With case insert and plastic box

Part number
3 39 01 131 94 0



QUICK CHARGER ALG 80 BC

Bluetooth® connectivity for connecting to a mobile end device and for use with the my.FEIN app. Shows the current charge state and the number of charge cycles to date on your smartphone or tablet. Provides notification when the battery is fully charged. Short charge times thanks to high charge current of 8 amps and process-controlled charge management. Large LED display with charge indicator and USB port for mobile charging of small electrical devices. For all FEIN Li-ion batteries. Charge times (80 % of max. capacity): 12 and 18 V / 3 Ah: 31 min., 12 and 18 V / 6 Ah: 38 min., 18 V / 5.2 Ah: 33 min.

Part number
9 26 04 210 01 0



BATTERY PACK

Li-ion battery with charge status indicator and FEIN SafetyCell technology. Protects the battery and tool from overload, overheating and total discharge. Can be used with all FEIN 18 V cordless tools.

Current/Voltages V	Capacity Ah	Weight kg	Part number
18	6	0,7	9 26 04 175 02 0
18	3	0,45	9 26 04 182 02 0



BATTERY STARTER SET

2 x Li-ion batteries with ALG 80 BC rapid charger. Bluetooth® connectivity for connecting to a mobile end device and for use with the my.FEIN app. Shows the current charge state and the number of charge cycles to date on your smartphone or tablet. Provides notification when the battery is fully charged. Short charge times thanks to high charge current of 8 amps and process-controlled charge management. Large LED display with charge indicator and USB port for mobile charging of small electrical devices. For all FEIN Li-ion batteries. Charge times (80 % of max. capacity): 12 and 18 V / 3 Ah: 31 min., 12 and 18 V / 6 Ah: 38 min., 18 V / 5.2 Ah: 33 min.

Current/Voltages V	Capacity Ah	Part number
18	6	9 26 04 323 01 0
18	3	9 26 04 324 01 0

ACCESSORIES FOR WBP 10



TOOL CASE
Plastic, inner dimensions: 470 x 275 x 116 mm

Part number
3 39 01 118 01 0



PLASTIC BOX

Box insert with lockable lid for small parts and accessories, suitable for tool box 3 39 01 118 01 0, max 5 items/box.

Part number
3 39 01 119 00 0

AGWP 10 SELECT**SUPPLIED**

1 additional handle,
1 plastic carrying case,
Threaded chuck not included
For accessories, see page 34

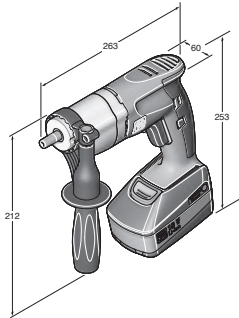

Fast, accurate thread drill with reversing gear for shorter working times.

Battery voltage	V	18
Battery compatibility		Li-ion/ HighPower Li-ion
Battery interface		18 V
Idling speed in reverse running	rpm	0 - 760
Load speed when cutting	rpm	0 - 440
Load speed in reverse running	rpm	0 - 670
Torque at max. output power	Nm	26
Stall torque	Nm	41
Thread in steel up to		M 10
Thread in stainless steel		M 10
Cone at drill shaft		B 12
Collar Ø	mm	43
Width across corners	mm	23
Weight without storage battery	kg	1,3

Part number	7 109 01 62 00 0
EAN	4014586885537

FEIN BENEFITS

- + Unique speed thanks to reversing gear for automatic reversal of rotation direction when retracting drill spindle from threaded hole. Rapid return action at 670 rpm for shorter cycle times.
- + Outstanding precision due to clearance-free connection of drill shaft and threaded chuck with B12 taper mounting for high concentricity. Positive fit of thread drill in chuck for the best results.
- + FEIN sensitive handle for applying feed force in the direct drilling axis while ensuring an ideal position in the guiding hand.
- + Brushless FEIN PowerDrive motor, fully encapsulated and dust-protected with 30 % higher efficiency and long service life.
- + Metal gear head.
- + Small width across corners of 23 mm.
- + FEIN SafetyCell technology. Protects the battery and tool from overload, overheating and total discharge.

GWP 10**SUPPLIED**

1 additional handle,
Threaded chuck not included
For accessories, see page 34

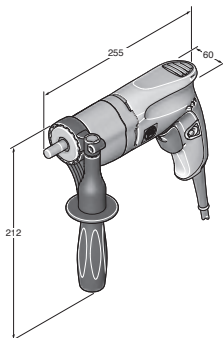

Fast, accurate thread drill with reversing gear for shorter working times.

Input	W	450
Output	W	250
Idling speed in reverse running	rpm	0 - 1,000
Load speed when cutting	rpm	0 - 450
Load speed in reverse running	rpm	0 - 680
Torque at max. output power	Nm	21
Stall torque	Nm	53
Thread in steel up to		M 10
Thread in stainless steel		M 10
Cone at drill shaft		B 12
Collar Ø	mm	43
Width across corners	mm	23
Cable with plug	m	5
Weight according to EPTA	kg	1,6

Part number	7 209 38 60 00 0
EAN	4014586881256

FEIN BENEFITS

- + Unique speed thanks to reversing gear for automatic reversal of rotation direction when retracting drill spindle from threaded hole. Rapid return action at 680 rpm for shorter cycle times.
- + Outstanding precision due to clearance-free connection of drill shaft and threaded chuck with B12 taper mounting for high concentricity. Positive fit of thread drill in chuck for the best results.
- + FEIN sensitive handle for applying feed force in the direct drilling axis while ensuring an ideal position in the guiding hand.
- + FEIN high-power motor with stable speed.
- + Small width across corners of 23 mm.
- + Metal gear head.
- + Distortion-free barrel-type motor housing.

GENERAL ACCESSORIES**TOOL CASE**

With case insert and plastic box
Plastic, inner dimensions: 470 x 275 x 116 mm

Part number
3 39 01 131 08 0

**QUICK CHARGER ALG 80 BC**

Bluetooth® connectivity for connecting to a mobile end device and for use with the my.FEIN app. Shows the current charge state and the number of charge cycles to date on your smartphone or tablet. Provides notification when the battery is fully charged. Short charge times thanks to high charge current of 8 amps and process-controlled charge management. Large LED display with charge indicator and USB port for mobile charging of small electrical devices. For all FEIN Li-ion batteries. Charge times (80 % of max. capacity): 12 and 18 V / 3 Ah: 31 min., 12 and 18 V / 6 Ah: 38 min., 18 V / 5.2 Ah: 33 min.

Part number
9 26 04 210 01 0

**BATTERY PACK**

Li-ion battery with charge status indicator and FEIN SafetyCell technology. Protects the battery and tool from overload, overheating and total discharge. Can be used with all FEIN 18 V cordless tools.

Current/Voltages V	Capacity Ah	Weight kg	Part number
18	6	0,7	9 26 04 175 02 0
18	3	0,45	9 26 04 182 02 0

**BATTERY STARTER SET**

2 x Li-ion batteries with ALG 80 BC rapid charger. Bluetooth® connectivity for connecting to a mobile end device and for use with the my.FEIN app. Shows the current charge state and the number of charge cycles to date on your smartphone or tablet. Provides notification when the battery is fully charged. Short charge times thanks to high charge current of 8 amps and process-controlled charge management. Large LED display with charge indicator and USB port for mobile charging of small electrical devices. For all FEIN Li-ion batteries. Charge times (80 % of max. capacity): 12 and 18 V / 3 Ah: 31 min., 12 and 18 V / 6 Ah: 38 min., 18 V / 5,2 Ah: 33 min.

Current/Voltages V	Capacity Ah	Part number
18	6	9 26 04 323 01 0
18	3	9 26 04 324 01 0

**COLLET CHUCK**

with collets 3,5/4,5/6 mm

Part number
6 32 06 063 01 2

**FLOATING COLLET CHUCK**

with collets 3,5/4,5/6 mm

Part number
6 32 06 076 02 2

**COLLETS**

for collet chucks and floating collet chucks and tapping adapters.

M2 (DIN 352, DIN 371), M4 (DIN 357, DIN 376)

Ø mm	Square mm	Part number
2,8	2,1	6 32 06 077 00 1

**COLLETS**

for collet chucks and floating collet chucks and tapping adapters.

M3 (DIN 352, DIN 371), M5 (DIN 357, DIN 376)

Ø mm	Square mm	Part number
3,5	2,7	6 32 06 064 00 1

**COLLETS**

for collet chucks and floating collet chucks and tapping adapters.

M4 (DIN 352, DIN 371), M6 (DIN 357, DIN 376)

Ø mm	Square mm	Part number
4,5	3,4	6 32 06 065 00 5

**COLLETS**

for collet chucks and floating collet chucks and tapping adapters.

M5 (DIN 352, DIN 371), M6 (DIN 352), M7 (DIN 352), M8 (DIN 352, DIN 357, DIN 376)

Ø mm	Square mm	Part number
6	4,9	6 32 06 066 00 8

**COLLETS**

for collet chucks and floating collet chucks and tapping adapters.

M7 (DIN 371), M9 (DIN 352) M 10 (DIN 352, DIN 357, DIN 376)

Ø mm	Square mm	Part number
7	5,5	6 32 06 070 00 6

**COLLETS**

for collet chucks and floating collet chucks and tapping adapters.

M8 (DIN 371), M11 (DIN 352)

Ø mm	Square mm	Part number
8	6,2	6 32 06 078 00 9

**COLLETS**

for collet chucks and floating collet chucks and tapping adapters.

M10 (DIN 371)

Ø mm	Square mm	Part number
10	8	6 32 06 079 00 3

**COLLETS**

for collet chucks and floating collet chucks and tapping adapters.

M12 (DIN 357, DIN 371, DIN 376)

Ø mm	Square mm	Part number
9	7	6 32 06 075 00 4

**JAW CHUCK**

for tapping drill direct adaptor clamping range 2.8 - 9.0 mm, with key wrench

Part number
6 32 06 019 00 9

**FLOATING JAW CHUCK**

for tapping drill direct adaptor clamping range 2.8 - 9.0 mm, with key wrench

Part number
6 32 06 041 00 8

**DRIFTS**

for drill chuck up to B12, length 125 mm, pack of 2

Mount	Length mm	Part number
B 12	125	6 33 05 009 01 3

**DEPTH STOP**

Part number
3 21 27 005 00 6

**CUTTING PASTE**

Lubricating agents for working on sheet metals.

Part number
3 21 32 020 12 9

ACCESSORIES FOR GWP 10**SUSPENSION DEVICE**

for hooking onto a balancer horizontal and vertical

Part number
3 21 25 050 00 7



IBS 16	MBS 16 X	MBS 25 F	MBS 32 F
Industrial drill jig for drills with drilling capacity of up to 16 mm.	Flexible magnetic drill jig for rotary drills with up to 16 mm drill capacity.	Flexible magnetic drill jig with fine adjustment for rotary drills with up to 23 mm drill capacity.	Flexible magnetic drill jig with fine adjustment for rotary drills with up to 32 mm drill capacity.

PAGE		37	37	37	38
Input	W		100	100	130
Socket max.	A		16	16	16
For collar Ø	mm	53	43	53	63 / 65
Twist drill max. Ø	mm	16	16	25	32
Tapping		M 12	M 12	M 20	M 24
Countersinking max. Ø	mm	50	50	50	60
Reaming max. Ø	mm	16	16	25	40
Stroke	mm	145	145	145	178
Swivel range for drill jigs				7°	350°
Total stroke range	mm	295	325	290	365
Adjustment range for drill jigs	mm			6	10
Magnetic holding power	N		12,500	14,000	18,000
Magnetic foot dimensions	mm		195 x 90	205 x 95	220 x 100
Cable with plug	m		4	4	4
Weight according to EPTA	kg	8	9,5	12,5	21,8

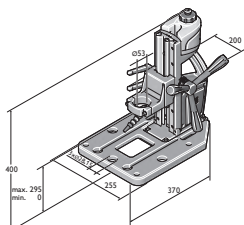

IBS 16

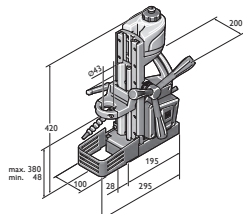

MBS 16 X

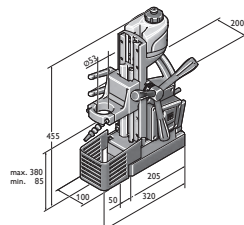

MBS 25 F

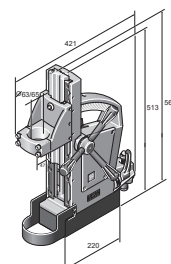

MBS 32 F

IBS 16

Industrial drill jig for drills with drilling capacity of up to 16 mm.



For collar Ø	mm	53
Twist drill max. Ø	mm	16
Tapping		M 12
Countersinking max. Ø	mm	50
Reaming max. Ø	mm	16
Stroke	mm	145
Total stroke range	mm	295
Weight according to EPTA	kg	8
Part number		9 03 20 223 00 0
EAN		4014586878515

FEIN BENEFITS

- + Lightweight, compact industrial drill jig with aluminium base plate for universal use, including drilling, tapping, reaming and countersinking.
- + Double drill motor guide for use with very large drilling tools.
- + Base plate with hole pattern for Demmeler and Siegmund System 28 welding tables.
- + Integrated coolant tank with flexible jointed hose.
- + Feed handwheel can be moved from one side to the other.
- + Carriage height adjustable without tools.

SUPPLIED

1 coolant tank, 1 flex-jointed hose,
1 reducing ring, diameter 43 mm

For accessories, see page 39

MBS 16 X

Flexible magnetic drill jig for rotary drills with up to 16 mm drill capacity.



Input	W	100
Socket max.	A	16
For collar Ø	mm	43
Twist drill max. Ø	mm	16
Tapping		M 12
Countersinking max. Ø	mm	50
Reaming max. Ø	mm	16
Stroke	mm	145
Total stroke range	mm	325
Magnetic holding power	N	12,500
Magnetic foot dimensions	mm	195 x 90
Cable with plug	m	4
Weight according to EPTA	kg	9,5
Part number		9 03 18 223 00 0
EAN		4014586878034

FEIN BENEFITS

- + Lightweight, compact magnetic drill jig for universal use, including drilling, tapping, reaming and countersinking.
- + Double drill motor guide for use with very large drilling tools.
- + High magnetic holding power and safety circuit guarantee safe working in any position.
- + Integrated coolant tank with flexible jointed hose.
- + Feed handwheel can be moved from one side to the other.
- + Carriage height adjustable without tools.

SUPPLIED

1 coolant tank, 1 lashing strap,
1 contact guard

For accessories, see page 39

MBS 25 F

Flexible magnetic drill jig with fine adjustment for rotary drills with up to 23 mm drill capacity.



Input	W	100
Socket max.	A	16
For collar Ø	mm	53
Twist drill max. Ø	mm	25
Tapping		M 20
Countersinking max. Ø	mm	50
Reaming max. Ø	mm	25
Stroke	mm	145
Total stroke range	mm	290
Adjustment range for drill jigs	mm	6
Swivel range for drill jigs		7°
Magnetic holding power	N	14,000
Magnetic foot dimensions	mm	205 x 95
Cable with plug	m	4
Weight according to EPTA	kg	12,5
Part number		9 03 19 223 00 0
EAN		4014586878041

FEIN BENEFITS

- + Universal suitability for drilling, tapping, reaming and countersinking.
- + Fine adjustment of the drill spindle for convenient tool alignment.
- + Double drill motor guide for use with very large drilling tools.
- + Feed handwheel can be moved from one side to the other.
- + Integrated coolant tank with flexible jointed hose.
- + High magnetic holding force.
- + Carriage height adjustable without tools.

SUPPLIED

1 coolant tank, 1 lashing strap,
1 contact guard, 1 reducing ring,
diameter 43 mm

For accessories, see page 39

MBS 32 F**SUPPLIED**

1 clamping strap, 1 swarf hook,
1 swarf guard, 2 keys

For accessories, see page 39

Flexible magnetic drill jig with fine adjustment for rotary drills with up to 32 mm drill capacity.

Input	W	130
Socket max.	A	16
For collar Ø	mm	63 / 65
Twist drill max. Ø	mm	32
Tapping		M 24
Countersinking max. Ø	mm	60
Reaming max. Ø	mm	40
Stroke	mm	178
Total stroke range	mm	365
Adjustment range for drill jigs	mm	10
Swivel range for drill jigs		350°
Magnetic holding power	N	18,000
Magnetic foot dimensions	mm	220 x 100
Cable with plug	m	4
Weight according to EPTA	kg	21,8

FEIN BENEFITS

- + Universal suitability for drilling, tapping, reaming and countersinking.
- + Fine adjustment of drill spindle for easy alignment of machine without constantly removing and refitting the magnet.
- + High magnetic holding power and safety circuit guarantee safe working in any position.
- + Infinitely variable stroke range setting.
- + Compact design.
- + Optimum power-to-weight ratio.
- + Robust and accurate dual dove-tail guide
- + Universal use for drive machines with clamping collar.

Part number	9 03 16 223 00 8
EAN	4014586847924

ACCESSORIES FOR IBS 16

REDUCING RINGS
for attaching machines with collar Ø 43 mm
FEIN BOS, KBH

Ø mm	Part number
53 / 43	3 26 23 014 01 0

ACCESSORIES FOR MBS 16 X

REDUCING RINGS
for attaching machines with collar Ø 33 mm.

Ø mm	Part number
43 / 33	3 26 23 012 01 9



REDUCING RINGS
for attaching machines with collar Ø 38 mm

Ø mm	Part number
43 / 38	3 26 23 013 00 4

ACCESSORIES FOR MBS 25 F

REDUCING RINGS
for attaching machines with collar Ø 38 mm

Ø mm	Part number
53 / 38	3 26 23 010 00 8



REDUCING RINGS
for attaching machines with collar Ø 43 mm

Ø mm	Part number
53 / 43	3 26 23 009 00 6



REDUCING RINGS
for attaching machines with collar Ø 43 mm
FEIN BOS, KBH

Ø mm	Part number
53 / 43	3 26 23 014 01 0

ACCESSORIES FOR MBS 16 X, MBS 25 F, MBS 32 F

SUCTION PLATE
for anti-magnetic materials, 250 x 330 x 110 mm

Part number
9 26 02 054 01 6



VACUUM PLATE
for anti-magnetic materials and structured bases
(corrugated sheet, stud plate etc.)
Vacuum plate 396 x 200 x 95 mm

Part number
9 26 02 057 01 7



PIPE DRILLING DEVICE
incl. clamping strap, for positioning bores on pipes with
pipe Ø of 60 to 300 mm, 220 x 130 mm.

Part number
9 26 02 055 01 0



VACUUM PUMP
Suction rate 0,015 m³/min, -0,8 bar, 92 W, weight 2,5 kg
including suction hose

Part number
9 26 01 022 01 3



18 V
Li-Ion

FASTENING

DRILL/DRIVER **42**

The optimum combination of flexibility, power and reliability. Designed for drilling, tapping and screwdriving in metal.

CORDLESS IMPACT WRENCH/DRIVER **50**

Unbeatably efficient and always reliable. Wide ranges of use and can withstand permanent loads.

ACCUTEC SCREW GUNS WITH MID-MOUNTED HANDLE **55**

Long-life precision cordless drill/driver for soft and hard screw connections in industrial volume production.

ACCUTEC BATON OFFSET SCREWDRIVER **56**

Long-life precision cordless drill/driver for soft and hard screw connections in industrial volume production.

METAL SCREW GUN **60**

For safe, consistent working with self-drilling and thread-moulding screws in roof and facade construction as well as heating, air conditioning and ventilation.

DRY WALL SCREW GUNS **62**

The specialist tools for drywall and interior applications. Lightweight, ergonomic and compact for optimum results.



	ASCM 18 QM SELECT	ASCM 18 QSW SELECT	ABS 18 Q SELECT	ASB 18 Q SELECT	ASCM 12 Q SELECT	ABSU 12 SELECT	ABSU 12 W4 SELECT
	4-speed cordless drill/driver with brushless motor and QuickIN MAX interface. No compromise on performance for drilling and tapping up to 12 mm and drilling with carbide hole saws.	Small and light 4-speed cordless drill/driver with brushless motor and QuickIN interface. Perfectly suited to universal drilling and screwdriving up to 8 mm.	2-speed cordless drill/driver with brushless motor and QuickIN interface. Perfectly suited to drilling and tapping up to 10 mm.	2-speed cordless combi drill with brushless motor and QuickIN interface. Perfectly suited to drilling up to 10 mm in metal, stone and masonry.	4-speed cordless drill/driver with brushless motor and QuickIN interface. Perfectly suited to drilling and tapping up to 8 mm and screwdriving.	2-speed cordless drill/driver with solid metal drill chuck. Perfect for universal drilling and screwdriving up to 6 mm.	2-speed cordless drill/driver with 1/4" tool mounting. Powerful torque for screw connections up to 6 x 200 mm.

PAGE		43	43	44	44	45	46	46
Removable drill chuck		•	•	•	•	•		
Electronic torque shut-off			•					
Battery voltage	V	18	18	18	18	12	12	12
Battery compatibility		Li-ion/High-Power Li-ion	Li-ion/High-Power Li-ion	Li-ion/High-Power Li-ion	Li-ion/High-Power Li-ion	Li-ion	Li-ion	Li-ion
Battery interface		18 V	MultiVolt	MultiVolt	MultiVolt	12 V	12 V	12 V
Motor		brushless	brushless	brushless	brushless	brushless	2-pole DC	2-pole DC
Gearbox		4-speed	4-speed	2-speed	2-speed	4-speed	2-speed	2-speed
Accessory interface		QuickIN MAX	QuickIN	QuickIN	QuickIN	QuickIN		
Speed, no load	rpm	400 / 800 / 1,950 / 3,850	400 / 700 / 1,400 / 2,500	450 / 2,000	450 / 2,000	400 / 700 / 1,400 / 2,500	400 / 1,300	400 / 1,300
Impacts	rpm				7,360 / 32,000			
Max. torque (hard/soft)	Nm	90 / 45	40 / 20	60 / 32	60 / 32	40 / 20	20 / 14	20 / 14
Torque levels		15 + 1	20 + 1	22 + 1	22 + 1	20 + 1	17 + 1	17 + 1
Drill chuck clamping width	mm	1.5 - 13	1.5 - 13	1.5 - 13	1.5 - 13	1.5 - 13	1 - 10	
Fastening	mm	10 x 400	8 x 200	8 x 300	8 x 300	8 x 200	6 x 200	6 x 200
Tool Holder								1/4" hexagonal holder
Capacity in steel Ø	mm	25	13	13	13	13	10	
Capacity in wood Ø	mm	50	40	50	50	40	30	
Capacity in stone Ø	mm				13			
Tapping		M 12	M 8	M 10	M 10	M 8	M 6	
Weight without storage battery	kg	1,5	1,2	1,3	1,3	1,1	1	0,8

• included

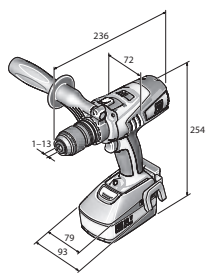

ASCM 18 QM

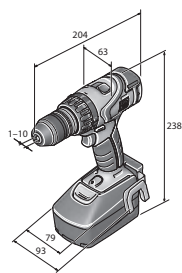

ABS 18 Q

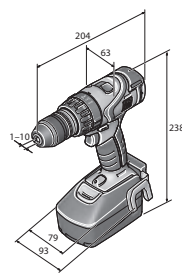

ASB 18 Q

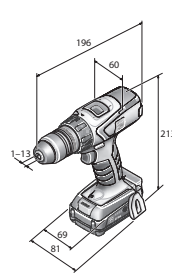

ASCM 12 Q

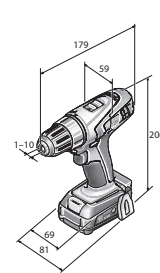

ABSU 12

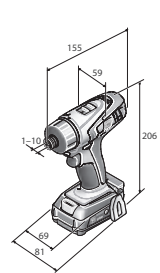

ABSU 12 W4

ASCM 18 QM SELECT



SUPPLIED

1 QuickIN drill chuck (120 Nm),
1 belt clip, 1 magnetic bit storage,
1 handle, 1 plastic carrying case

For accessories, see page 47

4-speed cordless drill/driver with brushless motor and QuickIN MAX interface. No compromise on performance for drilling and tapping up to 12 mm and drilling with carbide hole saws.

Battery voltage	V	18
Battery compatibility		Li-ion/ HighPower Li-ion
Battery interface		18 V
Motor		brushless
Gearbox		4-speed
Accessory interface		QuickIN MAX
Speed, no load	rpm	400 / 800 / 1,950 / 3,850
Max. torque (hard/soft)	Nm	90 / 45
Torque levels		15 + 1
Drill chuck clamping width	mm	1.5 - 13
Fastening	mm	10 x 400
Capacity in steel Ø	mm	25
Capacity in wood Ø	mm	50
Tapping		M 12
Weight without storage battery	kg	1,5

Part number	7 116 11 64 00 0
EAN	4014586887340

FEIN BENEFITS

- + Brushless FEIN PowerDrive motor, fully encapsulated and dust-protected with 30 % higher efficiency and long service life.
- + 4-speed solid metal gearbox. Optimum cutting speeds for drilling in metal and self-drilling screwdriving.
- + QuickIN MAX accessory interface for all QuickIN and QuickIN MAX accessories. Quick change between applications.
- + High torques up to 90 Nm.
- + Including QuickIN solid metal drill chuck (120 Nm) with carbide-tipped clamping jaws and high clamping forces.
- + In speed 4, optimum speeds (3850 rpm) for small diameters.
- + In speed 3, optimum speeds (1950 rpm) for 8 mm diameters.
- + Speed 1 for powerful thread cutting.
- + Electronic torque setting.
- + Fixes 10 x 400 mm screws without pre-drilling.
- + 2,500 screw connections (5 x 40 mm in wood) with one battery charge (6 Ah).
- + One charger for all FEIN Li-ion batteries of all voltage classes.
- + The battery charge can be read off the battery.
- + FEIN SafetyCell technology. Protects the battery and tool from overload, overheating and total discharge.
- + Extensive user protection features include restart protection, electronic overload protection and brake.

ASCM 18 QSW SELECT



SUPPLIED

1 QuickIN drill chuck (120 Nm),
1 belt clip, 1 magnetic bit storage,
1 plastic carrying case

For accessories, see page 47

Small and light 4-speed cordless drill/driver with brushless motor and QuickIN interface. Perfectly suited to universal drilling and screwdriving up to 8 mm.

Battery voltage	V	18
Battery compatibility		Li-ion/ HighPower Li-ion
Battery interface		MultiVolt
Motor		brushless
Gearbox		4-speed
Accessory interface		QuickIN
Speed, no load	rpm	400 / 700 / 1,400 / 2,500
Max. torque (hard/soft)	Nm	40 / 20
Torque levels		20 + 1
Drill chuck clamping width	mm	1.5 - 13
Fastening	mm	8 x 200
Capacity in steel Ø	mm	13
Capacity in wood Ø	mm	40
Tapping		M 8
Weight without storage battery	kg	1,2

Part number	7 116 12 64 00 0
EAN	4014586889900

FEIN BENEFITS

- + Brushless FEIN PowerDrive motor with 30 % higher efficiency and long service life.
- + 4-speed solid metal gearbox. Optimum cutting speeds for drilling in metal and self-drilling screwdriving.
- + QuickIN accessory interface for all QuickIN accessories. Quick change between applications.
- + Flexibility with the FEIN MultiVolt interface. Tool can be operated with all FEIN Li-ion batteries (12 to 18V).
- + High torques up to 40 Nm.
- + In speed 4, optimum speeds (2500 rpm) for diameters of up to 6 mm.
- + Mechanical torque setting.
- + Compact, lightweight design.
- + 550 screw connections (5 x 40 mm in wood) with one battery charge (3 Ah).
- + Including QuickIN solid metal drill chuck (120 Nm) with carbide-tipped clamping jaws and high clamping forces.
- + One charger for all FEIN Li-ion batteries of all voltage classes.
- + The battery charge can be read off the battery.
- + FEIN SafetyCell technology. Protects the battery and tool from overload, overheating and total discharge.
- + Extensive user protection features include restart protection, electronic overload protection and brake.

Determine the tool speed based on cutting speed and hole diameter.

4-speed cordless drill/driver ASCM 18 QM

Hole diameter	Cutting speed (m/min)			
	15	30	40	50
mm				
2	Speed 3	Speed 4	Speed 4	Speed 4
4	Speed 2	Speed 3	Speed 4	Speed 4
6	Speed 2	Speed 3	Speed 3	Speed 3
8	Speed 1	Speed 2	Speed 3	Speed 3
10	Speed 1	Speed 2	Speed 2	Speed 3
12	Speed 1	Speed 2	Speed 2	Speed 2

4-speed cordless drill/driver ASCM 18 QSW / ASCM 12 Q

Hole diameter	Cutting speed (m/min)			
	15	30	40	50
mm				
2	Speed 4	Speed 4	Speed 4	Speed 4
4	Speed 3	Speed 4	Speed 4	Speed 4
6	Speed 2	Speed 3	Speed 4	Speed 4
8	Speed 1	Speed 3	Speed 3	Speed 3
10	-	-	-	-
12	-	-	-	-

ABS 18 Q SELECT

2-speed cordless drill/driver with brushless motor and QuickIN interface. Perfectly suited to drilling and tapping up to 10 mm.

ASB 18 Q SELECT

2-speed cordless combi drill with brushless motor and QuickIN interface. Perfectly suited to drilling up to 10 mm in metal, stone and masonry.

Battery voltage	V	18	18
Battery compatibility		Li-ion/HighPower Li-ion	Li-ion/HighPower Li-ion
Battery interface		MultiVolt	MultiVolt
Motor		brushless	brushless
Gearbox		2-speed	2-speed
Accessory interface		QuickIN	QuickIN
Speed, no load	rpm	450 / 2,000	450 / 2,000
Impacts	rpm	--	7,360 / 32,000
Max. torque (hard/soft)	Nm	60 / 32	60 / 32
Torque levels		22 + 1	22 + 1
Drill chuck clamping width	mm	1.5 - 13	1.5 - 13
Fastening	mm	8 x 300	8 x 300
Capacity in steel Ø	mm	13	13
Capacity in wood Ø	mm	50	50
Capacity in stone Ø	mm	--	13
Tapping		M 10	M 10
Weight without storage battery	kg	1,3	1,3

FEIN BENEFITS

- + Brushless FEIN PowerDrive motor with 30 % higher efficiency and long service life.
- + QuickIN accessory interface for all QuickIN accessories. Quick change between applications.
- + MultiVolt interface. Cordless tool can be operated with all FEIN Li-ion batteries (12-18 V).
- + 2-speed solid metal gearbox for drilling in metal and self-drilling screwdriving.
- + Including QuickIN solid metal drill chuck (120 Nm) with carbide-tipped clamping jaws and high clamping forces.
- + Mechanical torque setting.
- + Compact design.
- + 900 screw connections (5 x 40 mm in wood) with one battery charge (3 Ah).
- + One charger for all FEIN Li-ion batteries of all voltage classes.
- + The battery charge can be read off the battery.
- + FEIN SafetyCell technology. Protects the battery and tool from overload, overheating and total discharge.
- + Extensive user protection features include restart protection, electronic overload protection and brake.

SUPPLIED

1 QuickIN drill chuck (120 Nm), 1 belt clip, 1 magnetic bit storage, 1 plastic carrying case

Part number	7 113 22 64 00 0	7 113 23 64 00 0
EAN	4014586887203	4014586887265

For accessories, see page 47

ASCM 12 Q SELECT**SUPPLIED**

1 QuickIN drill chuck (60 Nm),
1 belt clip, 1 magnetic bit storage,
1 plastic carrying case

For accessories, see page 47

4-speed cordless drill/driver with brushless motor and QuickIN interface. Perfectly suited to drilling and tapping up to 8 mm and screwdriving.

Battery voltage	V	12
Battery compatibility		Li-ion
Battery interface		12 V
Motor		brushless
Gearbox		4-speed
Accessory interface		QuickIN
Speed, no load	rpm	400 / 700 / 1,400 / 2,500
Max. torque (hard/soft)	Nm	40 / 20
Torque levels		20 + 1
Drill chuck clamping width	mm	1.5 - 13
Fastening	mm	8 x 200
Capacity in steel Ø	mm	13
Capacity in wood Ø	mm	40
Tapping		M 8
Weight without storage battery	kg	1,1

Part number	7 116 10 64 00 0
EAN	4014586885698

FEIN BENEFITS

- + Brushless FEIN PowerDrive motor with 30 % higher efficiency and long service life.
- + 4-speed solid metal gearbox. Optimum cutting speeds for drilling in metal and self-drilling screwdriving.
- + QuickIN accessory interface for all QuickIN accessories. Quick change between applications.
- + High torques up to 40 Nm.
- + Including small QuickIN solid metal drill chuck (60 Nm) with high concentricity.
- + In speed 4, optimum speeds (2500 rpm) for diameters of up to 6 mm.
- + Mechanical torque setting.
- + Can be set down safely on the battery.
- + Slim handle.
- + 450 screw connections (5 x 40 mm in wood) with one battery charge (3 Ah).
- + One charger for all FEIN Li-ion batteries of all voltage classes.
- + The battery charge can be read off the battery.
- + FEIN SafetyCell technology. Protects the battery and tool from overload, overheating and total discharge.

ABSU 12 SELECT

2-speed cordless drill/driver with solid metal drill chuck. Perfect for universal drilling and screwdriving up to 6 mm.

ABSU 12 W4 SELECT

2-speed cordless drill/driver with 1/4" tool mounting. Powerful torque for screw connections up to 6 x 200 mm.

Battery voltage	V	12	12
Battery compatibility		Li-ion	Li-ion
Battery interface		12 V	12 V
Motor		2-pole DC	2-pole DC
Gearbox		2-speed	2-speed
Speed, no load	rpm	400 / 1,300	400 / 1,300
Max. torque (hard/soft)	Nm	20 / 14	20 / 14
Torque levels		17 + 1	17 + 1
Drill chuck clamping width	mm	1 - 10	--
Fastening	mm	6 x 200	6 x 200
Tool Holder		--	1/4" hexagonal holder
Capacity in steel Ø	mm	10	--
Capacity in wood Ø	mm	30	--
Tapping		M 6	--
Weight without storage battery	kg	1	0,8

FEIN BENEFITS

- + Powerful and long-life DC motor with overheating and overload protection.
 - + 2-speed solid metal gearbox for universal drilling and screwdriving.
 - + Robust solid metal drill chuck with chucking force safety device.
 - + Mechanical torque setting.
 - + Can be set down safely on the battery.
 - + Slim handle.
 - + Compact design.
 - + 400 screw connections (5 x 40 mm in wood) with one battery charge (3 Ah).
 - + One charger for all FEIN Li-ion batteries of all voltage classes.
 - + The battery charge can be read off the battery.
 - + FEIN SafetyCell technology. Protects the battery and tool from overload, overheating and total discharge.
- + 2-speed solid metal gearbox for universal screwdriving.
 - + Short and light thanks to 1/4" tool mounting and the fact that there is no drill chuck.
 - + Very short design of 155 mm.

SUPPLIED

1 belt clip, 1 magnetic bit storage, 1 plastic carrying case

Part number	7 113 20 64 00 0	7 113 21 64 00 0
EAN	4014586885568	4014586885575

For accessories, see page 47

GENERAL ACCESSORIES



CORDLESS ALED 12-18 V LED LAMP

Compact and durable cordless LED lamp with swivel-mounted lamp head. Compatible with all 12 / 14 / 18 V FEIN Li-ion batteries, including hook for attaching the lamp. Extremely lightweight at 130 g and very bright at 900 Lux. Colour temperature is the equivalent of daylight. The brightness can be set to 2 levels.

Part number

9 26 04 200 02 0



AUSB 12-18 V CORDLESS USB ADAPTER

Compact cordless USB adapter for charging smartphones, tablets etc. without a mains connection. 2 high-speed USB charging ports for rapid charging at 2x 1.2 amps. Suitable for iOS and Android. Compatible with all 12 / 14 / 18 V FEIN Li-ion batteries.

Part number

9 26 04 201 02 0



TOOL CASE

Plastic, inner dimensions: 470 x 275 x 116 mm

Part number

3 39 01 118 01 0



TOOL CASE

Suitable for ABSU 12, ASCD 12, ASCM 12

Part number

3 39 01 157 32 0



PLASTIC BOX

Box insert with lockable lid for small parts and accessories, suitable for tool box 3 39 01 118 01 0, max 5 items/box.

Part number

3 39 01 119 00 0



TOOL HOLDER 1/4" EXTERNAL HEXAGON

1/4" Drive-Hex Socket with quick-change chuck

Ø mm	L mm	Part number
15	51	6 05 10 011 00 9

18 V BATTERY



QUICK CHARGER ALG 80 BC

Bluetooth® connectivity for connecting to a mobile end device and for use with the my.FEIN app. Shows the current charge state and the number of charge cycles to date on your smartphone or tablet. Provides notification when the battery is fully charged. Short charge times thanks to high charge current of 8 amps and process-controlled charge management. Large LED display with charge indicator and USB port for mobile charging of small electrical devices. For all FEIN Li-ion batteries. Charge times (80 % of max. capacity): 12 and 18 V / 3 Ah: 31 min., 12 and 18 V / 6 Ah: 38 min., 18 V / 5.2 Ah: 33 min.

Part number

9 26 04 210 01 0



BATTERY PACK

Li-ion battery with charge status indicator and FEIN SafetyCell technology. Protects the battery and tool from overload, overheating and total discharge. Can be used with all FEIN 18 V cordless tools.

Current/Voltages V	Capacity Ah	Weight kg	Part number
18	6	0,7	9 26 04 175 02 0
18	3	0,45	9 26 04 182 02 0



BATTERY STARTER SET

2 x Li-ion batteries with ALG 80 BC rapid charger. Bluetooth® connectivity for connecting to a mobile end device and for use with the my.FEIN app. Shows the current charge state and the number of charge cycles to date on your smartphone or tablet. Provides notification when the battery is fully charged. Short charge times thanks to high charge current of 8 amps and process-controlled charge management. Large LED display with charge indicator and USB port for mobile charging of small electrical devices. For all FEIN Li-ion batteries. Charge times (80 % of max. capacity): 12 and 18 V / 3 Ah: 31 min., 12 and 18 V / 6 Ah: 38 min., 18 V / 5.2 Ah: 33 min.

Current/Voltages V	Capacity Ah	Part number
18	6	9 26 04 323 01 0
18	3	9 26 04 324 01 0

12 V BATTERY



QUICK CHARGER ALG 80

The high charge current of 8 amps and process-controlled charge management make for short charge times. Large LED with charge state indicator and USB port for the mobile charging of small electronic devices, such as smartphones or tablets. For all FEIN Li-ion batteries. Charge times (80 % of max. capacity): 12 and 18 V / 3 Ah: 31 min., 12 and 18 V / 6 Ah: 38 min., 18 V / 5.2 Ah: 33 min.

Part number

9 26 04 180 01 0



BATTERY PACK

Li-ion battery with charge status indicator and FEIN SafetyCell technology. Protects the battery and tool from overload, overheating and total discharge. Can be used with all FEIN 12 V cordless tools and 18 V cordless tools with MultiVolt interface.

Current/Voltages V	Capacity Ah	Weight kg	Part number
12	6	0,45	9 26 04 184 02 0
12	3	0,25	9 26 04 183 02 0



BATTERY STARTER SET

2 x Li-ion batteries with ALG 80 rapid charger. The high charge current of 8 amps and process-controlled charge management make for short charge times. Large LED with charge state indicator and USB port for the mobile charging of small electronic devices, such as smartphones or tablets. Charge times (80 % of max. capacity): 12 and 18 V / 3 Ah: 31 min., 12 and 18 V / 6 Ah: 38 min.

Current/Voltages V	Capacity Ah	Part number
12	6	9 26 04 327 01 0
12	3	9 26 04 326 01 0

QUICKIN ACCESSORIES



DRILL CHUCK

Small solid metal drill chuck from Röhm, maximum torque 60 Nm. Compatible with all FEIN cordless drill/drivers with QuickIN/QuickIN MAX interface.

Accessory interface	Part number
QuickIN	6 32 08 002 01 0



DRILL CHUCK

Solid metal drill chuck from Röhm with carbide-tipped clamping jaws and high clamping forces. Screwdriver bit may remain in the drive shaft, the drill chuck moves above the bit. Maximum torque 120 Nm. Compatible with all FEIN cordless drill/drivers with QuickIN/QuickIN MAX interface.

Accessory interface	Part number
QuickIN	6 32 08 005 01 0



DRILL CHUCK

Solid metal drill chuck from Röhm with flat jaws and automatic re-tensioning. Prevents twist drills and threading drills from slipping. Clamping range of 1.5 - 13 mm. High concentricity of up to 0.35 mm for precise working. Compatible with all FEIN cordless drill/drivers with QuickIN / QuickIN MAX interface.

Accessory interface	Part number
QuickIN	6 42 03 006 01 0



BIT HOLDER

1/4" hexagon socket bit holder with convenient one-handed operation and powerful neodymium magnet. Use of the bit holder makes the screwdriver lighter and shorter. Compatible with all FEIN cordless drill/drivers with QuickIN/QuickIN MAX interface.

Accessory interface	Part number
QuickIN	6 05 10 222 01 0



SOCKET ADAPTER

Socket adapter to hold sockets with 1/2" square holder. Compatible with all FEIN cordless drill/drivers with QuickIN/QuickIN MAX interface.

Accessory interface	Part number
QuickIN	6 42 03 002 01 0



ANGLED HEAD

Metal angled head for drilling, tapping and screwdriving in confined spaces. All FEIN QuickIN accessories such as drill chucks, bit holders or socket adapters can be attached to the angled head. Compatible with all FEIN cordless drill/drivers with QuickIN/QuickIN MAX interface.

Accessory interface	Part number
QuickIN	6 42 03 008 01 0



TAPPING ADAPTER

Tapping adapter with 2 collets for shank diameter of 4.5 mm and 6 mm to cut thread sizes M4 / M5 / M6 / M8. Reliable thread drill hold on the square, preventing slipping. Compatible with all FEIN cordless drill/drivers with QuickIN/QuickIN MAX interface.

Accessory interface	Part number
QuickIN	6 42 03 003 01 0



TAPPING ADAPTER

Reliable thread drill hold on the square, preventing slipping. Compatible with all FEIN collets and all FEIN cordless drill/drivers with QuickIN/QuickIN MAX interface.

Accessory interface	Part number
QuickIN	6 42 03 003 02 0



TAPPING COLLET

Efficient thread tapping through reliable tapping drill hold on the square, preventing slipping. The tapping drill bit can be easily changed without the need for any tools. Supplied without tapping drill. Compatible with all FEIN cordless drill/drivers with QuickIN/QuickIN MAX interface.

Accessory interface	Ø mm	Square mm	Part number
QuickIN	3,5	2,7	6 42 03 009 01 0
QuickIN	4,5	3,4	6 42 03 010 01 0
QuickIN	6	4,9	6 42 03 011 01 0
QuickIN	7	5,5	6 42 03 012 01 0
QuickIN	8	6,2	6 42 03 013 01 0
QuickIN	9	7	6 42 03 014 01 0
QuickIN	10	8	6 42 03 015 01 0
QuickIN	11	9	6 42 03 016 01 0



QUICKIN SET OF ACCESSORIES FOR METAL

QuickIN set of accessories for cordless drill/drivers for efficient metalworking. Comprising bit holder (1/4"), socket adapter (1/2") and tapping adapter with 2 collects for shank diameters of 4.5 and 6 mm. Compatible with all FEIN cordless drill/drivers with QuickIN/QuickIN MAX interface.

Accessory interface	Part number
QuickIN	6 42 03 017 02 0



HOLE SAW ADAPTER

To drill large holes in metal. Suitable for all FEIN carbide hole saws and core drills with QuickIN PLUS holder. Perfectly suited to diameters of up to 40 mm. Supplied with centring bit, without hole saw. Compatible with all FEIN cordless drill/drivers with QuickIN / QuickIN MAX interface.

Accessory interface	Part number
QuickIN	6 42 03 007 01 0

OTHER ACCESSORIES



COLLETS

for collet chucks and floating collet chucks and tapping adapters. M2 (DIN 352, DIN 371), M4 (DIN 357, DIN 376)

Ø mm	Square mm	Part number
2,8	2,1	6 32 06 077 00 1



COLLETS

for collet chucks and floating collet chucks and tapping adapters. M3 (DIN 352, DIN 371), M5 (DIN 357, DIN 376)

Ø mm	Square mm	Part number
3,5	2,7	6 32 06 064 00 1



COLLETS

for collet chucks and floating collet chucks and tapping adapters. M4 (DIN 352, DIN 371), M6 (DIN 357, DIN 376)

Ø mm	Square mm	Part number
4,5	3,4	6 32 06 065 00 5



COLLETS

for collet chucks and floating collet chucks and tapping adapters. M5 (DIN 352, DIN 371), M6 (DIN 352), M7 (DIN 352), M8 (DIN 352, DIN 357, DIN 376)

Ø mm	Square mm	Part number
6	4,9	6 32 06 066 00 8



COLLETS

for collet chucks and floating collet chucks and tapping adapters. M7 (DIN 371), M9 (DIN 352) M 10 (DIN 352, DIN 357, DIN 376)

Ø mm	Square mm	Part number
7	5,5	6 32 06 070 00 6



COLLETS

for collet chucks and floating collet chucks and tapping adapters. M8 (DIN 371), M11 (DIN 352)

Ø mm	Square mm	Part number
8	6,2	6 32 06 078 00 9



COLLETS

for collet chucks and floating collet chucks and tapping adapters. M12 (DIN 357, DIN 371, DIN 376)

Ø mm	Square mm	Part number
9	7	6 32 06 075 00 4



COLLETS

for collet chucks and floating collet chucks and tapping adapters. M10 (DIN 371)

Ø mm	Square mm	Part number
10	8	6 32 06 079 00 3



CARBIDE HOLE SAW WITH QUICKIN PLUS HOLDER

Carbide cutting tips for optimum service life for efficient drilling in sheet metal plate up to 4 mm thick. Metric dimensions, cutting depth 4 mm.

Cutting depth mm	Bore Ø mm	Part number
4	14	6 31 31 014 01 0
4	15	6 31 31 015 01 0
4	16	6 31 31 016 01 0
4	17	6 31 31 017 01 0
4	18	6 31 31 018 01 0
4	19	6 31 31 019 01 0
4	20	6 31 31 020 01 0
4	21	6 31 31 021 01 0
4	22	6 31 31 022 01 0
4	23	6 31 31 023 01 0
4	24	6 31 31 024 01 0
4	25	6 31 31 025 01 0
4	26	6 31 31 026 01 0
4	27	6 31 31 027 01 0
4	28	6 31 31 028 01 0
4	29	6 31 31 029 01 0
4	30	6 31 31 030 01 0
4	31	6 31 31 031 01 0
4	32	6 31 31 032 01 0
4	33	6 31 31 033 01 0
4	34	6 31 31 034 01 0
4	35	6 31 31 035 01 0
4	36	6 31 31 036 01 0
4	37	6 31 31 037 01 0
4	38	6 31 31 038 01 0
4	39	6 31 31 039 01 0
4	40	6 31 31 040 01 0
4	41	6 31 31 041 01 0
4	42	6 31 31 042 01 0
4	43	6 31 31 043 01 0
4	44	6 31 31 044 01 0
4	45	6 31 31 045 01 0
4	46	6 31 31 046 01 0
4	47	6 31 31 047 01 0
4	48	6 31 31 048 01 0
4	49	6 31 31 049 01 0
4	50	6 31 31 050 01 0
4	51	6 31 31 051 01 0
4	52	6 31 31 052 01 0
4	53	6 31 31 053 01 0
4	54	6 31 31 054 01 0
4	55	6 31 31 055 01 0
4	56	6 31 31 056 01 0
4	57	6 31 31 057 01 0
4	58	6 31 31 058 01 0
4	59	6 31 31 059 01 0
4	60	6 31 31 060 01 0
4	65	6 31 31 065 01 0
4	68	6 31 31 068 01 0
4	70	6 31 31 070 01 0
4	75	6 31 31 075 01 0
4	80	6 31 31 080 01 0



CARBIDE HOLE SAW FOR PIPES WITH QUICKIN PLUS HOLDER

Carbide cutting tips for optimum service life for use with pipe material and curved surfaces with wall thicknesses of up to 4 mm. Metric dimensions, cutting depth 4 mm.

Cutting depth mm	Bore Ø mm	Part number
4	21	6 31 31 421 01 0
4	22	6 31 31 422 01 0
4	23	6 31 31 423 01 0
4	25	6 31 31 425 01 0
4	26	6 31 31 426 01 0
4	27	6 31 31 427 01 0
4	28	6 31 31 428 01 0
4	29	6 31 31 429 01 0
4	31	6 31 31 431 01 0
4	32	6 31 31 432 01 0
4	33	6 31 31 433 01 0
4	36	6 31 31 436 01 0
4	38	6 31 31 438 01 0
4	39	6 31 31 439 01 0
4	41	6 31 31 441 01 0
4	42	6 31 31 442 01 0
4	45	6 31 31 445 01 0
4	46	6 31 31 446 01 0
4	47	6 31 31 447 01 0
4	48	6 31 31 448 01 0
4	49	6 31 31 449 01 0
4	52	6 31 31 452 01 0
4	53	6 31 31 453 01 0
4	55	6 31 31 455 01 0
4	57	6 31 31 457 01 0
4	58	6 31 31 458 01 0
4	59	6 31 31 459 01 0
4	65	6 31 31 465 01 0
4	68	6 31 31 468 01 0



CARBIDE CORE DRILL BIT WITH QUICKIN PLUS HOLDER

Outstanding cutting performance in all common metals. Metric dimensions, cutting depth 20 mm, drilling diameter in steel up to 25 mm, drilling diameter in aluminium up to 30 mm.

Cutting depth mm	Bore Ø mm	Part number
20	14	6 31 30 014 01 0
20	15	6 31 30 015 01 0
20	16	6 31 30 016 01 0
20	17	6 31 30 017 01 0
20	18	6 31 30 018 01 0
20	19	6 31 30 019 01 0
20	20	6 31 30 020 01 0
20	21	6 31 30 021 01 0
20	22	6 31 30 022 01 0
20	23	6 31 30 023 01 0
20	24	6 31 30 024 01 0
20	25	6 31 30 025 01 0
20	26	6 31 30 026 01 0
20	27	6 31 30 027 01 0
20	28	6 31 30 028 01 0
20	29	6 31 30 029 01 0
20	30	6 31 30 030 01 0



CENTRING DRILL BIT

No. in pack pcs	Part number
1	6 31 14 038 01 0
5	6 31 14 038 02 0



	ASCD 18-1000 W34 SELECT	ASCD 18-300 W2 SELECT	ASCD 18-200 W4 SELECT	ASCD 12-150 W8 SELECT	ASCD 12-150 W4 SELECT	ASCD 12-100 W4 SELECT
	Cordless impact wrench/driver with brushless motor and 6-stage torque setting. For metric screw connections up to M27.	Cordless impact wrench/driver with brushless motor and 6-stage torque setting. For metric screwdriving applications up to M18.	Impact wrench/driver with brushless motor and 6-stage torque setting. For universal screwdriving applications including self-drilling screwdriving.	Cordless impact wrench/driver with brushless motor and 6-stage torque setting. For metric screwdriving applications up to M14.	Impact wrench/driver with brushless motor and 6-stage torque setting. For universal screwdriving applications including self-drilling screwdriving.	Cordless impact wrench/driver with DC motor. For universal screw connections.

PAGE		51	51	51	52	52	52
Battery voltage	V	18	18	18	12	12	12
Battery compatibility		Li-ion/ HighPower Li-ion	Li-ion/ HighPower Li-ion	Li-ion/ HighPower Li-ion	Li-ion	Li-ion	Li-ion
Battery interface		MultiVolt	MultiVolt	MultiVolt	12 V	12 V	12 V
Motor		brushless	brushless	brushless	brushless	brushless	2-pole DC
Speed, no load	rpm	0 - 1,800	0 - 1,700	0 - 1,500	0 - 1,800	0 - 1,700	0 - 2,700
Impacts	rpm	0 - 2,200	0 - 3,400	0 - 3,000	0 - 3,600	0 - 3,400	0 - 3,450
Max. torque	Nm	1,050	290	210	135	135	100
Max. metric screw		M27 (8.8)	M18 (8.8)		M14 (8.8)		
Torque levels		6	6	6	6	6	
Tool Holder		3/4" Outer square	1/2" Outer square	1/4" hexagon socket	3/8" Outer square	1/4" hexagon socket	1/4" hexagon socket
Weight without storage battery	kg	3	1	1	0,85	0,85	0,9

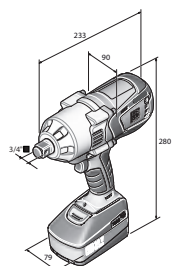

ASCD 18-1000 W34

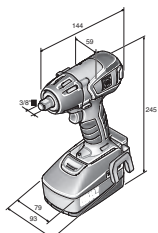

ASCD 18-300 W2

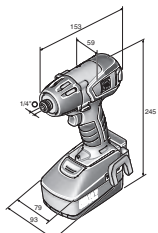

ASCD 18-200 W4

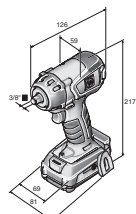

ASCD 12-150 W8C

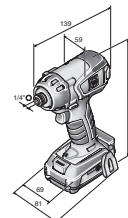

ASCD 12-150 W4C

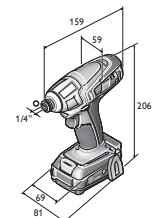

ASCD 12-100 W4C

ASCD 18-1000 W34 SELECT



SUPPLIED

1 plastic carrying case

For accessories, see page 53

Cordless impact wrench/driver with brushless motor and 6-stage torque setting. For metric screw connections up to M27.

Battery voltage	V	18
Battery compatibility		Li-ion/ HighPower Li-ion
Battery interface		MultiVolt
Motor		brushless
Speed, no load	rpm	0 - 1,800
Impacts	rpm	0 - 2,200
Max. torque	Nm	1,050
Torque levels		6
Tool Holder		3/4" Outer square
Max. metric screw		M27 (8.8)
Wood screw Ø	mm	12 x 600
Weight without storage battery	kg	3

FEIN BENEFITS

- + Electronic 6-stage torque setting prevents screw heads from being torn off.
- + High torque of up to 1050 Nm for tightening and loosening screws of up to M27.
- + Brushless FEIN PowerDrive motor with 30 % higher efficiency and long service life.
- + Maximum release torque of 1500 Nm in reverse running.
- + Secure socket connection on square drive thanks to force fit and positive fit.
- + 3/4" square head for holding sockets.
- + Robust solid metal impact gear.
- + MultiVolt interface. Cordless tool can be operated with all FEIN Li-ion batteries (12-18 V).
- + 130 screw connections (M27) with one battery charge (6 Ah).
- + One charger for all FEIN Li-ion batteries of all voltage classes.
- + The battery charge can be read off the battery.
- + FEIN SafetyCell technology. Protects the battery and tool from overload, overheating and total discharge.
- + Extensive user protection features include restart protection, electronic overload protection and brake.

Part number	7 115 08 64 00 0
EAN	4014586891651

ASCD 18-300 W2 SELECT



Cordless impact wrench/driver with brushless motor and 6-stage torque setting. For metric screwdriving applications up to M18.

ASCD 18-200 W4 SELECT



Impact wrench/driver with brushless motor and 6-stage torque setting. For universal screwdriving applications including self-drilling screwdriving.

Battery voltage	V	18	18
Battery compatibility		Li-ion/HighPower Li-ion	Li-ion/HighPower Li-ion
Battery interface		MultiVolt	MultiVolt
Motor		brushless	brushless
Speed, no load	rpm	0 - 1,700	0 - 1,500
Impacts	rpm	0 - 3,400	0 - 3,000
Max. torque	Nm	290	210
Torque levels		6	6
Tool Holder		1/2" Outer square	1/4" hexagon socket
Max. metric screw		M18 (8.8)	--
Wood screw Ø	mm	8 x 300	8 x 200
Weight without storage battery	kg	1	1

FEIN BENEFITS

- + Brushless FEIN PowerDrive motor with 30 % higher efficiency and long service life.
- + Electronic 6-stage torque setting prevents screw heads from being torn off.
- + 10 % more torque in reverse running to loosen screws which are extremely tight.
- + MultiVolt interface. Cordless tool can be operated with all FEIN Li-ion batteries (12-18 V).
- + 1/2" square for holding sockets.
- + Robust solid metal impact gear.
- + Contact guard on gearbox head.
- + Compact design.
- + 600 screw connections (M18) with one battery charge (6 Ah).
- + One charger for all FEIN Li-ion batteries of all voltage classes.
- + The battery charge can be read off the battery.
- + FEIN SafetyCell technology. Protects the battery and tool from overload, overheating and total discharge.
- + Extensive user protection features include restart protection, electronic overload protection and brake.
- + Metric screws up to M18 (8.8).
- + 1/4" hexagon socket for holding bits and socket wrench inserts.

SUPPLIED 1 belt clip, 1 magnetic bit storage, 1 plastic carrying case

Part number	7 115 06 64 00 0	7 115 07 64 00 0
EAN	4014586887425	4014586887449

For accessories, see page 53

ASCD 12-150 W8 SELECT

Cordless impact wrench/driver with brushless motor and 6-stage torque setting. For metric screwdriving applications up to M14.

ASCD 12-150 W4 SELECT

Impact wrench/driver with brushless motor and 6-stage torque setting. For universal screwdriving applications including self-drilling screwdriving.

Battery voltage	V	12	12
Battery compatibility		Li-ion	Li-ion
Battery interface		12 V	12 V
Motor		brushless	brushless
Speed, no load	rpm	0 - 1,800	0 - 1,700
Impacts	rpm	0 - 3,600	0 - 3,400
Max. torque	Nm	135	135
Torque levels		6	6
Tool Holder		3/8" Outer square	1/4" hexagon socket
Max. metric screw		M14 (8.8)	--
Wood screw Ø	mm	8 x 100	8 x 100
Weight without storage battery	kg	0,85	0,85

FEIN BENEFITS

- + Brushless FEIN PowerDrive motor with 30 % higher efficiency and long service life.
- + Electronic 6-stage torque setting prevents screw heads from being torn off.
- + 10 % more torque in reverse running to loosen screws which are extremely tight.
- + 3/8" square for holding sockets.
- + Robust solid metal impact gear.
- + Contact guard on gearbox head.
- + Can be set down safely on the battery.
- + Slim handle.
- + Compact design.
- + 400 screw connections (M14) with one battery charge (3 Ah).
- + One charger for all FEIN Li-ion batteries of all voltage classes.
- + The battery charge can be read off the battery.
- + FEIN SafetyCell technology. Protects the battery and tool from overload, overheating and total discharge.
- + Metric screws up to M14 (8.8).
- + 1/4" hexagon socket for holding bits and socket wrench inserts.

SUPPLIED

1 belt clip, 1 magnetic bit storage, 1 plastic carrying case

Part number	7 115 04 64 00 0	7 115 05 64 00 0
EAN	4014586887388	4014586887401

For accessories, see page 53

ASCD 12-100 W4 SELECT

Cordless impact wrench/driver with DC motor. For universal screw connections.

Battery voltage	V	12
Battery compatibility		Li-ion
Battery interface		12 V
Motor		2-pole DC
Speed, no load	rpm	0 - 2,700
Impacts	rpm	0 - 3,450
Max. torque	Nm	100
Tool Holder		1/4" hexagon socket
Wood screw Ø	mm	8 x 80
Weight without storage battery	kg	0,9

FEIN BENEFITS

- + Powerful and long-life DC motor with overheating and overload protection.
- + Up to 100 Nm torque - tightens screws of up to M12 with ease.
- + 1/4" hexagon socket for holding bits and socket wrench inserts.
- + Robust solid metal impact gear.
- + Aluminium gearbox housing.
- + Can be set down safely on the battery.
- + Slim handle.
- + 220 screw connections (M12) with one battery charge (3 Ah).
- + One charger for all FEIN Li-ion batteries of all voltage classes.
- + The battery charge can be read off the battery.
- + FEIN SafetyCell technology. Protects the battery and tool from overload, overheating and total discharge.

SUPPLIED

1 belt clip, 1 magnetic bit storage, 1 plastic carrying case

For accessories, see page 53

Part number	7 115 03 64 00 0
EAN	4014586885582

GENERAL ACCESSORIES



CORDLESS ALED 12-18 V LED LAMP

Compact and durable cordless LED lamp with swivel-mounted lamp head. Compatible with all 12 / 14 / 18 V FEIN Li-ion batteries, including hook for attaching the lamp. Extremely lightweight at 130 g and very bright at 900 Lux. Colour temperature is the equivalent of daylight. The brightness can be set to 2 levels.

Part number

9 26 04 200 02 0



AUSB 12-18 V CORDLESS USB ADAPTER

Compact cordless USB adapter for charging smartphones, tablets etc. without a mains connection. 2 high-speed USB charging ports for rapid charging at 2x 1.2 amps. Suitable for iOS and Android. Compatible with all 12 / 14 / 18 V FEIN Li-ion batteries.

Part number

9 26 04 201 02 0



TOOL CASE

Plastic, inner dimensions: 470 x 275 x 116 mm

Part number

3 39 01 118 01 0



TOOL CASE

Suitable for ABSU 12, ASCD 12, ASCM 12

Part number

3 39 01 157 32 0



PLASTIC BOX

Box insert with lockable lid for small parts and accessories, suitable for tool box 3 39 01 118 01 0, max 5 items/box.

Part number

3 39 01 119 00 0



REDUCTION ADAPTER

3/4" to 1/2" adapter

Part number

6 24 15 002 01 0



IMPACT SOCKET

Long, hexagonal, 3/4" fitting.

wrench size mm	Thread	Length mm	Part number
24	M16 (DIN/ISO)	95	6 24 05 323 01 0
27	M18 (DIN/ISO)	95	6 24 05 324 01 0
30	M20 (DIN/ISO)	95	6 24 05 325 01 0
32	M22 (DIN/ISO)	95	6 24 05 326 01 0
34	M24 (ISO)	95	6 24 05 327 01 0
36	M24 (DIN/ISO)	95	6 24 05 328 01 0
41	M27 (DIN/ISO)	95	6 24 05 329 01 0



SET OF IMPACT SOCKETS

Long, hexagonal, 3/4" fitting, content: widths across flats of 27, 30, 32, 36 and 41.

Length
mm

95

Part number

6 24 05 323 02 0



SECURING PIN

For 3/4" impact socket, diameter 4 mm, length 36 mm.

Part number

3 02 40 395 00 0



CIRCLIP

For 3/4" impact socket, diameter 38 mm.

Part number

3 02 40 396 00 0



LOCKING SET

For 3/4" impact socket comprising 3 circlips (diameter 38 mm) and 3 locking pins (diameter 4 mm, length 36 mm).

Part number

3 02 40 396 01 0

18 V BATTERY



QUICK CHARGER ALG 80 BC

Bluetooth® connectivity for connecting to a mobile end device and for use with the my.FEIN app. Shows the current charge state and the number of charge cycles to date on your smartphone or tablet. Provides notification when the battery is fully charged. Short charge times thanks to high charge current of 8 amps and process-controlled charge management. Large LED display with charge indicator and USB port for mobile charging of small electrical devices. For all FEIN Li-ion batteries. Charge times (80 % of max. capacity): 12 and 18 V / 3 Ah: 31 min., 12 and 18 V / 6 Ah: 38 min., 18 V / 5.2 Ah: 33 min.

Part number

9 26 04 210 01 0



BATTERY PACK

Li-ion battery with charge status indicator and FEIN SafetyCell technology. Protects the battery and tool from overload, overheating and total discharge. Can be used with all FEIN 18 V cordless tools.

Current/Voltages V	Capacity Ah	Weight kg	Part number
18	6	0,7	9 26 04 175 02 0
18	3	0,45	9 26 04 182 02 0



BATTERY STARTER SET

2 x Li-ion batteries with ALG 80 BC rapid charger. Bluetooth® connectivity for connecting to a mobile end device and for use with the my.FEIN app. Shows the current charge state and the number of charge cycles to date on your smartphone or tablet. Provides notification when the battery is fully charged. Short charge times thanks to high charge current of 8 amps and process-controlled charge management. Large LED display with charge indicator and USB port for mobile charging of small electrical devices. For all FEIN Li-ion batteries. Charge times (80 % of max. capacity): 12 and 18 V / 3 Ah: 31 min., 12 and 18 V / 6 Ah: 38 min., 18 V / 5.2 Ah: 33 min.

Current/Voltages V	Capacity Ah	Part number
18	6	9 26 04 323 01 0
18	3	9 26 04 324 01 0

12 V BATTERY**QUICK CHARGER ALG 80**

The high charge current of 8 amps and process-controlled charge management make for short charge times. Large LED with charge state indicator and USB port for the mobile charging of small electronic devices, such as smartphones or tablets. For all FEIN Li-ion batteries. Charge times (80 % of max. capacity): 12 and 18 V / 3 Ah: 31 min., 12 and 18 V / 6 Ah: 38 min., 18 V / 5.2 Ah: 33 min.

Part number

9 26 04 180 01 0

**BATTERY PACK**

Li-ion battery with charge status indicator and FEIN SafetyCell technology. Protects the battery and tool from overload, overheating and total discharge. Can be used with all FEIN 12 V cordless tools and 18 V cordless tools with MultiVolt interface.

Current/Voltages V	Capacity Ah	Weight kg	Part number
12	6	0,45	9 26 04 184 02 0
12	3	0,25	9 26 04 183 02 0

**BATTERY STARTER SET**

2 x Li-ion batteries with ALG 80 rapid charger. The high charge current of 8 amps and process-controlled charge management make for short charge times. Large LED with charge state indicator and USB port for the mobile charging of small electronic devices, such as smartphones or tablets. Charge times (80 % of max. capacity): 12 and 18 V / 3 Ah: 31 min., 12 and 18 V / 6 Ah: 38 min.

Current/Voltages V	Capacity Ah	Part number
12	6	9 26 04 327 01 0
12	3	9 26 04 326 01 0

ASM 18-3 PC

ASM 18-8 PC

ASM 18-12 PC



Parameterisable cordless screwdriver with mechanical shut-off clutch for industrial use.

Battery voltage	V	18	18	18
Battery interface		MultiVolt	MultiVolt	MultiVolt
Torque range	Nm	0.5 - 3	1 - 8	3 - 12
Speed, no load	rpm	110 - 1,200	110 - 1,200	80 - 900
Tool Holder		1/4" hexagon socket	1/4" hexagon socket	1/4" hexagon socket
Weight without storage battery	kg	0,8	0,8	0,8

FEIN BENEFITS

- + Process-capable according to ISO 5393, VDI/VDE 2647, achieves CMK value > 1.67 at ± 10 % (refers to 6 Sigma).
- + For soft and hard screwed connections.
- + Programmable parameters (up to 5 steps): speed, direction of rotation, angle of rotation, torque threshold, time.
- + Error criteria settings can prevent manipulation of the screwdriving process.
- + Infinitely variable speed adjustment.
- + Parameters can be set for forwards or reverse running.
- + Brushless motor with 30 % higher efficiency and long service life.
- + High speed stability for constant work progress.
- + Can be fully loaded up to maximum output torque during continuous operation.
- + Extra short design for use in tight spaces.
- + Fatigue-free working thanks to narrow grip dimensions and good balance.
- + Optimised air guide: air isn't blown onto the user's hand or into his or her face.
- + Extra large and bright signal unit (OK / not OK).
- + Optimum illumination of the screwdriving site.
- + Wear-free acceleration switch.
- + Tools can be colour-coded using coding rings.
- + Scope for attaching suspension bracket (balancer).
- + Integrated fastening counter means that a maintenance interval can be set.
- + Adjustable battery charge state display on tool.
- + MultiVolt interface. Cordless tool can be operated with all FEIN Li-ion batteries (12-18 V).

SUPPLIED

Supplied without battery, charger or torque wrench.

Part number	7 112 77 60 00 0	7 112 78 60 00 0	7 112 79 60 00 0
EAN	4014586891422	4014586891446	4014586891460

For accessories, see page 58

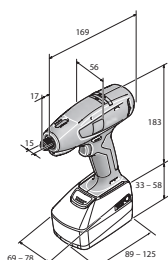

ASM 18-3 PC
 ASM 18-8 PC
 ASM 18-12 PC

ASW 18-6 PC

ASW 18-12 PC

ASW 18-18 PC



Parameterisable cordless screwdriver with mechanical shut-off clutch for industrial use.

Battery voltage	V	18	18	18
Battery interface		MultiVolt	MultiVolt	MultiVolt
Torque range	Nm	1.2 - 6	3 - 12	6 - 18
Speed, no load	rpm	100 - 1,340	75 - 1,020	65 - 900
Weight without storage battery	kg	1	1	1,2

FEIN BENEFITS

- + Process-capable according to ISO 5393, VDI/VDE 2647, achieves CMK value > 1.67 at ± 10 % (refers to 6 Sigma).
- + For soft and hard screwed connections.
- + Programmable parameters (up to 5 steps): speed, direction of rotation, angle of rotation, torque threshold, time.
- + Error criteria settings can prevent manipulation of the screwdriving process.
- + Infinitely variable speed adjustment.
- + Parameters can be set for forwards or reverse running.
- + Brushless FEIN PowerDrive motor with 30 % higher efficiency and long service life.
- + High speed stability for constant work progress.
- + Can be fully loaded up to maximum output torque during continuous operation.
- + Fatigue-free working thanks to narrow grip dimensions and good balance.
- + Optimised air guide: air isn't blown onto the user's hand or into his or her face.
- + Extra large and bright signal unit (OK / not OK).
- + Optimum illumination of the screwdriving site.
- + Wear-free acceleration switch.
- + Tools can be colour-coded using coding rings.
- + Scope for attaching suspension bracket (balancer).
- + Integrated fastening counter means that a maintenance interval can be set.
- + Adjustable battery charge state display on tool.
- + MultiVolt interface. Cordless tool can be operated with all FEIN Li-ion batteries (12-18 V).
- + Infinitely adjustable angle head alignment.

+ Angled head can be set in 30° steps.

SUPPLIED

Supplied without battery, charger, angled head or torque wrench.

Part number	7 112 66 60 00 0	7 112 68 60 00 0	7 112 70 60 00 0
EAN	4014586887920	4014586887968	4014586888002

For accessories, see page 58

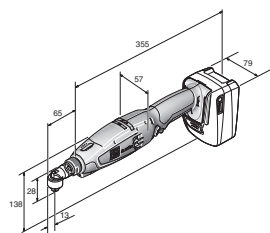

ASW 18-6 PC
ASW 18-12 PC

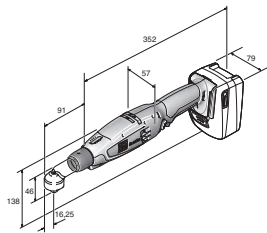

ASW 18-18 PC

ASW 18-30 PC**ASW 18-45 PC****ASW 18-60 PC**

Parameterisable cordless screwdriver with mechanical shut-off clutch for industrial use.

Battery voltage	V	18	18	18
Battery interface		MultiVolt	MultiVolt	MultiVolt
Torque range	Nm	12 - 30	20 - 45	25 - 60
Speed, no load	rpm	30 - 420	25 - 310	20 - 230
Weight without storage battery	kg	1,5	1,5	1,65

FEIN BENEFITS

- + Process-capable according to ISO 5393, VDI/VDE 2647, achieves CMK value > 1.67 at $\pm 10\%$ (refers to 6 Sigma).
- + For soft and hard screwed connections.
- + Programmable parameters (up to 5 steps): speed, direction of rotation, angle of rotation, torque threshold, time.
- + Error criteria settings can prevent manipulation of the screwdriving process.
- + Infinitely variable speed adjustment.
- + Parameters can be set for forwards or reverse running.
- + Brushless FEIN PowerDrive motor with 30 % higher efficiency and long service life.
- + High speed stability for constant work progress.
- + Can be fully loaded up to maximum output torque during continuous operation.
- + Fatigue-free working thanks to narrow grip dimensions and good balance.
- + Optimised air guide: air isn't blown onto the user's hand or into his or her face.
- + Extra large and bright signal unit (OK / not OK).
- + Optimum illumination of the screwdriving site.
- + Wear-free acceleration switch.
- + Tools can be colour-coded using coding rings.
- + Scope for attaching suspension bracket (balancer).
- + Integrated fastening counter means that a maintenance interval can be set.
- + Adjustable battery charge state display on tool.
- + MultiVolt interface. Cordless tool can be operated with all FEIN Li-ion batteries (14.4-18 V).
- + Angled head can be set in 30° steps.

+ Angled head can be set in 60° steps.

SUPPLIED

Supplied without battery, charger, angled head or torque wrench.

Part number	7 112 62 60 00 0	7 112 63 60 00 0	7 112 64 60 00 0
EAN	4014586883830	4014586883847	4014586883854

For accessories, see page 58

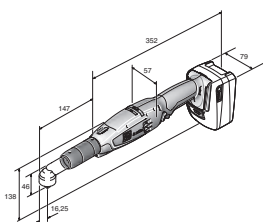

ASW 18-30 PC
ASW 18-45 PC

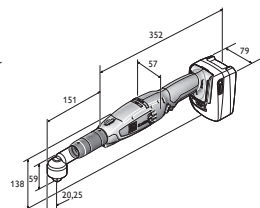

ASW 18-60 PC

GENERAL ACCESSORIES



BATTERY PACK

Li-ion battery with charge status indicator and FEIN SafetyCell technology. Protects the battery and tool from overload, overheating and total discharge. Can be used with all FEIN 12 V cordless tools and 18 V cordless tools with MultiVolt interface.

Current/Voltages V	Capacity Ah	Weight kg	Part number
12	6	0,45	9 26 04 184 02 0
12	3	0,25	9 26 04 183 02 0



BATTERY PACK

Li-ion battery with charge status indicator and FEIN SafetyCell technology. Protects the battery and tool from overload, overheating and total discharge. Can be used with all FEIN 18 V cordless tools.

Current/Voltages V	Capacity Ah	No. in pack pcs	Weight kg	Part number
18	6	1	0,7	9 26 04 175 02 0
18	6	12	0,7	9 26 04 175 03 0
18	3	1	0,45	9 26 04 182 02 0
18	3	12	0,45	9 26 04 182 03 0



QUICK CHARGER ALG 80

The high charge current of 8 amps and process-controlled charge management make for short charge times. Large LED with charge state indicator and USB port for the mobile charging of small electronic devices, such as smartphones or tablets. For all FEIN Li-ion batteries. Charge times (80 % of max. capacity): 12 and 18 V / 3 Ah: 31 min., 12 and 18 V / 6 Ah: 38 min., 18 V / 5.2 Ah: 33 min.

No. in pack pcs	Part number
1	9 26 04 180 01 0
25	9 26 04 180 02 0



ADJUSTMENT SPANNER - TORQUE

Part number
3 21 23 002 00 6



BATTERY COVER

for protecting the work piece surface from mechanical damages for Li-Ion battery 18 V 3 Ah

Part number
3 21 74 020 01 0



BATTERY COVER

for protecting the work piece surface from mechanical damages for Li-Ion battery 18 V 6 Ah

Part number
3 21 74 019 01 0



BATTERY COVER

for protecting the work piece surface from mechanical damages for Li-Ion battery 12 V 3 Ah

Part number
3 21 74 025 01 0



BATTERY COVER

for protecting the work piece surface from mechanical damages for Li-Ion battery 12 V 6 Ah

Part number
3 21 74 029 01 0



TOOL HOLDER

Tool storage for all FEIN AccuTec models.

Part number
3 21 26 012 01 0



CODING SLEEVES

for colour IDs of different models

Colour	No. in pack pcs	Part number
Colour mix	7	3 05 01 352 02 0
blue	10	3 05 01 355 01 0
red	10	3 05 01 356 01 0
orange	10	3 05 01 357 01 0
yellow	10	3 05 01 358 01 0
grey	10	3 05 01 353 01 0
green	10	3 05 01 354 01 0
black	10	3 05 01 352 01 0

ASM ACCESSORIES



PROTECTION FOR ACCUTEC ASM

for protecting the work piece surface from mechanical damages

Model	Part number
ASM 18	3 21 74 028 01 0

ASW ACCESSORIES



ACCUTEC ASW PROTECTIVE COVER

for protecting the work piece surface from mechanical damages

Model	Part number
ASW 18	3 21 74 024 01 0



ANGLED HEAD UP TO 14 NM

3/8" angle head (square head) (DIN 3121-E10) with width across corners of 40 mm and a weight of 0.15 kg. For ASW 18-6 (PC), ASW 18-12 (PC), ASW 14-6 (PC), 14-10 (PC), 14-14 (PC), ASW 10-X and ASW 9-10.

Tool Holder	Part number
3/8" Outer square	9 01 02 018 02 0



ANGLED HEAD UP TO 14 NM

1/4" angle head (square head) (DIN 3121-E6,3) with width across corners of 36 mm and a weight of 0.15 kg. For ASW 18-6 (PC), ASW 18-12 (PC), ASW 14-6 (PC), 14-10 (PC), 14-14 (PC), ASW 10-X and ASW 9-10.

Tool Holder	Part number
1/4" Outer square	9 01 02 019 02 0

**ANGLED HEAD UP TO 14 NM**

1/4" angle head (hexagon socket) (DIN ISO 1173-D6,3) with width across corners of 30 mm and a weight of 0.14 kg. For ASW 18-6 (PC), ASW 18-12 (PC), ASW 14-6 (PC), 14-10 (PC), 14-14 (PC), ASW 10-X and ASW 9-10.

Tool Holder	Part number
1/4" hexagon socket	9 01 02 020 02 0

**ANGLED HEAD UP TO 14 NM**

1/4" angle head (QuickIN hexagon socket) (DIN ISO 1173-F6,3) with width across corners of 47 mm and a weight of 0.16 kg. For ASW 18-6 (PC), ASW 18-12 (PC), ASW 14-6 (PC), 14-10 (PC), 14-14 (PC), ASW 10-X and ASW 9-10.

Tool Holder	Part number
QuickIN 1/4" Hexagon socket	9 01 02 021 02 0

**ANGLED HEAD UP TO 18 NM**

ASW 18-18 (PC)

Tool Holder	Part number
3/8" Outer square	9 01 02 017 02 0

**ANGLED HEAD UP TO 45 NM**

ASW 18-30 PC, ASW 18-45 PC

Tool Holder	Part number
3/8" Outer square	9 01 02 015 02 0

**ANGLED HEAD UP TO 60 NM**

ASW 18-60 PC

Tool Holder	Part number
1/2" Outer square	9 01 02 016 02 0

**STRAIGHT OUTPUT**

ASW 14-6 (PC), ASW 14-10 (PC), ASW 14-14 (PC), ASW 18-6 (PC), ASW 18-12 (PC)
Can be used between 1.1 - 9.9 Nm.

Tool Holder	Part number
QuickIN 1/4" Hexagon socket	9 01 06 001 02 0
3/8" Outer square	9 01 06 002 02 0

**PLASTIC COVER**

for protecting the work piece surface from mechanical damages

Model	Part number
<14 Nm	3 21 74 023 01 0

**PLASTIC COVER**

for protecting the work piece surface from mechanical damages

Model	Part number
<45 Nm	3 21 74 022 01 0

**PLASTIC COVER**

for protecting the work piece surface from mechanical damages

Model	Part number
<60 Nm	3 21 74 021 01 0

**EXTENSION**

To reduce the reaction torque and for better accessibility. 100 mm, for ASW18-30 PC, ASW18-45 PC and ASW18-60 PC.

Part number
6 42 03 005 01 0

**HANDLE**

For ASW14-30 PC, ASW18-30 PC, ASW18-45 PC and ASW18-60 PC.

Part number
3 21 19 150 01 0

**SICKLE SPANNER**

For securing the angled head on ASW 18-18 (PC), ASW 18-30/45/60 PC.

Part number
6 29 08 014 00 0

**SUSPENSION DEVICE**

for hooking onto a balancer horizontal and vertical

Part number
3 21 25 050 00 7

ACCESSORIES FOR PARAMETER CONTROL MODELS**PROGRAMMING ADAPTER**

For all AccuTec ParameterControl models. Supplied: Software on USB card incl. instructions, adapter and connection cable.

Part number
9 26 04 163 02 0

For more information about the FEIN AccuTec range and to download the Parameter Control PC software, please visit www.fein.com.



ASCS 6.3 SELECT**SUPPLIED**

1 hook, 1 depth stop,
1 insert for hexagon bolts SW 8,
1 plastic carrying case

For accessories, see page 61



Speed-optimised cordless drill/driver for screw connections in metal up to a diameter of 6.3 mm.

Battery voltage	V	18
Battery compatibility		Li-ion/ HighPower Li-ion
Battery interface		18 V
Speed, full load	rpm	0 - 1,500
Speed, no load	rpm	0 - 1,700
Max. torque (hard/soft)	Nm	30 / 10
Screw Ø	mm	6,3
Rapid change chuck		1/4"
Weight without storage battery	kg	1,1

Part number	7 113 11 63 00 0
EAN	4014586881461

FEIN BENEFITS

- + 180 screw connections (in steel sheet metal) with one battery charge (6 Ah).
- + Electronic torque shut-off for precise results even without a depth stop.
- + Brushless FEIN PowerDrive motor, fully encapsulated and dust-protected with 30 % higher efficiency and long service life.
- + Tested for more than 1 million screw connections.
- + More than 1,000 charge cycles per battery pack.
- + Extremely light weight.
- + Optimum ergonomics with gun handle for high contact pressure.
- + Powerful up to 30 Nm.
- + FEIN SafetyCell technology. Protects the battery and tool from overload, overheating and total discharge.
- + Extensive user protection features include restart protection, electronic overload protection and brake.

SCS 4.8-25**SUPPLIED**

1 depth stop, 1 magnetic holder for bits 1/4", 1 bit 1/4" for cross-slotted screws size 2 / Phillips (form H) extra hard, 1 hand strap, 1 belt clip

For accessories, see page 61

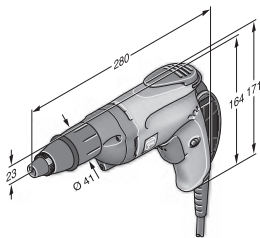

One of the lightest self-drilling screwdriver in its class for roof and facade construction.

Input	W	450
Output	W	250
Speed, full load	rpm	0 - 2,000
Speed, no load	rpm	0 - 2,500
Max. torque (hard/soft)	Nm	16
Screw Ø	mm	4,8
Rapid change chuck		1/4"
Cable with plug	m	5
Weight according to EPTA	kg	1,3

Part number	7 213 04 00 23 9
EAN	4014586853734

FEIN BENEFITS

- + Safe working with self-drilling and thread-moulding screws up to 4.8 mm with or without sealing disc. It is also suitable for wing screws.
- + Lightweight drill/driver for fatigue-free working in roof and facade construction as well as heating, air conditioning and ventilation.
- + Adjustable, power-sensitive FEIN universal clutch for optimum configuration of torque when working without depth stop.
- + FEIN high-power motor.
- + Practical hand strap.

GENERAL ACCESSORIES

**CORDLESS ALED 12-18 V LED LAMP**

Compact and durable cordless LED lamp with swivel-mounted lamp head. Compatible with all 12 / 14 / 18 V FEIN Li-ion batteries, including hook for attaching the lamp. Extremely lightweight at 130 g and very bright at 900 Lux. Colour temperature is the equivalent of daylight. The brightness can be set to 2 levels.

Part number

9 26 04 200 02 0

**AUSB 12-18 V CORDLESS USB ADAPTER**

Compact cordless USB adapter for charging smartphones, tablets etc. without a mains connection. 2 high-speed USB charging ports for rapid charging at 2x 1.2 amps. Suitable for iOS and Android. Compatible with all 12 / 14 / 18 V FEIN Li-ion batteries.

Part number

9 26 04 201 02 0

**TOOL CASE**

Plastic, inner dimensions: 470 x 275 x 116 mm

Part number

3 39 01 118 01 0

**PLASTIC BOX**

Box insert with lockable lid for small parts and accessories, suitable for tool box 3 39 01 118 01 0, max 5 items/box.

Part number

3 39 01 119 00 0

**QUICK CHARGER ALG 80 BC**

Bluetooth® connectivity for connecting to a mobile end device and for use with the my.FEIN app. Shows the current charge state and the number of charge cycles to date on your smartphone or tablet. Provides notification when the battery is fully charged. Short charge times thanks to high charge current of 8 amps and process-controlled charge management. Large LED display with charge indicator and USB port for mobile charging of small electrical devices. For all FEIN Li-ion batteries. Charge times (80 % of max. capacity): 12 and 18 V / 3 Ah: 31 min., 12 and 18 V / 6 Ah: 38 min., 18 V / 5.2 Ah: 33 min.

Part number

9 26 04 210 01 0

**TOOL HOLDER 1/4" EXTERNAL HEXAGON**

1/4" Drive-Hex Socket with quick-change chuck

Ø mm	L mm	Part number
15	51	6 05 10 011 00 9

**TOOL HOLDER 1/4" EXTERNAL HEXAGON**

1/4" Drive-Hex Socket with spring washer, magnetic

Ø mm	L mm	Part number
10,6	45	6 05 10 215 00 3

18 V BATTERY

**BATTERY PACK**

Li-ion battery with charge status indicator and FEIN SafetyCell technology. Protects the battery and tool from overload, overheating and total discharge. Can be used with all FEIN 18 V cordless tools.

Current/Voltages V	Capacity Ah	Weight kg	Part number
18	6	0,7	9 26 04 175 02 0
18	3	0,45	9 26 04 182 02 0

**BATTERY STARTER SET**

2 x Li-ion batteries with ALG 80 BC rapid charger. Bluetooth® connectivity for connecting to a mobile end device and for use with the my.FEIN app. Shows the current charge state and the number of charge cycles to date on your smartphone or tablet. Provides notification when the battery is fully charged. Short charge times thanks to high charge current of 8 amps and process-controlled charge management. Large LED display with charge indicator and USB port for mobile charging of small electrical devices. For all FEIN Li-ion batteries. Charge times (80 % of max. capacity): 12 and 18 V / 3 Ah: 31 min., 12 and 18 V / 6 Ah: 38 min., 18 V / 5.2 Ah: 33 min.

Current/Voltages V	Capacity Ah	Part number
18	6	9 26 04 323 01 0
18	3	9 26 04 324 01 0



	ASCT 18 SELECT	ASCT 18 M SELECT	SCT 5-40 X	SCT 5-40 UX	SCT 5-40 M
	Very powerful cordless drywall screw gun with outstanding service life.	Powerful autofeed screwdriver for more than 2,300 repeated screw fittings per battery charge.	The specialist tool for drywall and interior work with quiet clutch.	The flexible tool for drywall and interior work with adjustable clutch.	Autofeed screwdriver for quick repeated screw fittings with quiet clutch.

		63	63	63	64	64
PAGE						
Input	W			450	450	450
Battery voltage	V	18	18			
Battery compatibility		Li-ion/ HighPower Li-ion	Li-ion/ HighPower Li-ion			
Battery interface		18 V	18 V			
Speed, full load	rpm	0 - 2,700	0 - 2,700	0 - 2,700	0 - 2,700	0 - 2,700
Speed, no load	rpm	0 - 4,000	0 - 4,000	0 - 4,000	0 - 4,000	0 - 4,000
Max. torque (hard/soft)	Nm	14 / 7	14 / 7	12 / -	12 / -	12 / -
Screw Ø	mm	4,2	4,2	5	5	5
Screw length	mm					25 - 55
Rapid change chuck		1/4"	1/4"	1/4"	1/4"	1/4"
Weight according to EPTA	kg			1,3	1,3	1,6
Weight without storage battery	kg	1	1,5			

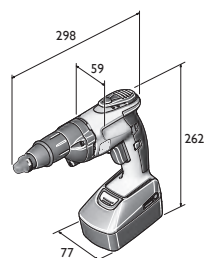

ASCT 18

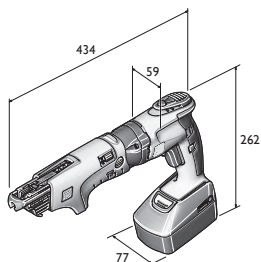

ASCT 18 M

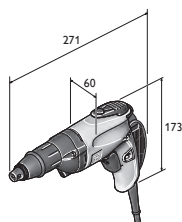

SCT 5-40 X
SCT 5-40 UX

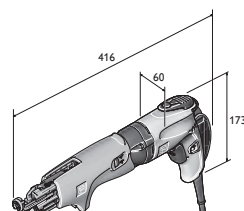

SCT 5-40 M

ASCT 18 SELECT

Very powerful cordless drywall screw gun with outstanding service life.



SUPPLIED

1 bit with dust protection ring, 1 bit holder, 1 depth stop, 1 hook, 1 belt clip, 1 plastic carrying case

For accessories, see page 65

Battery voltage	V	18
Battery compatibility		Li-ion/ HighPower Li-ion
Battery interface		18 V
Speed, full load	rpm	0 - 2,700
Speed, no load	rpm	0 - 4,000
Max. torque (hard/soft)	Nm	14 / 7
Screw Ø	mm	4,2
Rapid change chuck		1/4"
Weight without storage battery	kg	1

Part number	7 113 16 65 00 0
EAN	4014586887562

FEIN BENEFITS

- + Suited to all screwdriving applications in drywall construction, including high-strength chipboard and hard sheets of drywall.
- + Low weight and perfect weight distribution for fatigue-free working.
- + Brushless FEIN PowerDrive motor, fully encapsulated and dust-protected with 30 % higher efficiency and long service life.
- + One of the lightest screwdrivers in its class.
- + 2000 screw connections (in plasterboard) with one battery charge (6 Ah).
- + Rapid charger for continuous working without interruption.
- + 2,000 charge cycles per battery pack.
- + Market-leading ergonomics with FEIN Sensitive handle.
- + Quiet and vibration-free cut-off with FEIN CLIC-STOP clutch.
- + Rapid changeover to collated strip magazine.
- + Easily adjustable and replaceable depth stop.
- + Dustproof stop sleeve.
- + FEIN SafetyCell technology. Protects the battery and tool from overload, overheating and total discharge.
- + Extensive user protection features include restart protection, electronic overload protection and brake.

ASCT 18 M SELECT

Powerful autoseed screwdriver for more than 2,300 repeated screw fittings per battery charge.



SUPPLIED

1 Collated cartridge for collated screws, 1 long bit for magazine screw connections, 1 bit with dust protection ring, 1 bit holder, 1 depth stop, 1 hook, 1 belt clip, 1 plastic carrying case

For accessories, see page 65

Battery voltage	V	18
Battery compatibility		Li-ion/ HighPower Li-ion
Battery interface		18 V
Speed, full load	rpm	0 - 2,700
Speed, no load	rpm	0 - 4,000
Max. torque (hard/soft)	Nm	14 / 7
Screw Ø	mm	4,2
Rapid change chuck		1/4"
Weight without storage battery	kg	1,5

Part number	7 113 16 64 00 0
EAN	4014586887555

FEIN BENEFITS

- + Suited to all screwdriving applications in drywall construction, including high-strength chipboard and hard sheets of drywall.
- + Low weight and perfect weight distribution for fatigue-free working.
- + Brushless FEIN PowerDrive motor, fully encapsulated and dust-protected with 30 % higher efficiency and long service life.
- + One of the lightest screwdrivers in its class.
- + 2000 screw connections (in plasterboard) with one battery charge (6 Ah).
- + Rapid charger for continuous working without interruption.
- + 2,000 charge cycles per battery pack.
- + Quiet and vibration-free cut-off with FEIN CLIC-STOP clutch.
- + The particularly dust-resistant magazine can be inserted and removed without the use of tools and is easy to clean.
- + Market-leading ergonomics with FEIN Sensitive handle.
- + Easily adjustable and replaceable depth stop.
- + Dustproof stop sleeve.
- + FEIN SafetyCell technology. Protects the battery and tool from overload, overheating and total discharge.
- + Extensive user protection features include restart protection, electronic overload protection and brake.

SCT 5-40 X

The specialist tool for drywall and interior work with quiet clutch.



SUPPLIED

1 hand strap, 1 belt clip, 1 depth stop, dust-proof protection, 1 magnetic holder for bits 1/4", 1 bit 1/4" for cross-slotted screws size 2 / Phillips (form H) with dust-protection ring

For accessories, see page 65

Input	W	450
Output	W	250
Speed, full load	rpm	0 - 2,700
Speed, no load	rpm	0 - 4,000
Max. torque (hard/soft)	Nm	12 / -
Screw Ø	mm	5
Rapid change chuck		1/4"
Cable with plug	m	5
Weight according to EPTA	kg	1,3

Part number	7 213 13 00 23 0
EAN	4014586860923

FEIN BENEFITS

- + Speed-optimised; for rapid fixing of plasterboard to wood or metal frames.
- + Silent FEIN CLIC-STOP clutch for working in offices, hospitals etc. without causing a disturbance.
- + The depth stop supplied means that drywall is not damaged and you need simply grout after screwdriving.
- + One of the lightest screwdrivers in its class.
- + Market-leading ergonomics with FEIN Sensitive handle.
- + Point placement accuracy with infinitely variable electronic speed setting.
- + FEIN high-power motor.
- + Vibration-free stop.
- + Rapid changeover to collated strips.
- + Easily adjustable and replaceable depth stop.
- + Dustproof stop sleeve.
- + Extremely lightweight.
- + Practical hand strap.

SCT 5-40 UX**SUPPLIED**

1 hand strap, 1 belt clip, 1 depth stop, dust-proof protection, 1 bit 1/4" for cross-slotted screws size 2 / Phillips (form H) with dust-protection ring, 1 magnetic holder for bits 1/4"

For accessories, see page 65

The flexible tool for drywall and interior work with adjustable clutch.

Input	W	450
Output	W	250
Speed, full load	rpm	0 - 2,700
Speed, no load	rpm	0 - 4,000
Max. torque (hard/soft)	Nm	12 / -
Screw Ø	mm	5
Rapid change chuck		1/4"
Cable with plug	m	5
Weight according to EPTA	kg	1,3

Part number	7 213 14 00 23 0
EAN	4014586860930

FEIN BENEFITS

- + Speed-optimised; for rapid fixing of plasterboard to wood or metal frames.
- + Optimum torque thanks to adjustable clutch when working without depth stop.
- + The depth stop supplied means that drywall is not damaged and you need simply grout after screwdriving.
- + Market-leading ergonomics with FEIN Sensitive handle.
- + FEIN high-power motor.
- + One of the lightest screwdrivers in its class.
- + Easily adjustable and replaceable depth stop.
- + Rapid changeover to collated strips.
- + Extremely lightweight.
- + Dustproof stop sleeve.
- + Practical hand strap.
- + Point placement accuracy with infinitely variable electronic speed setting.

SCT 5-40 M**SUPPLIED**

1 Collated cartridge for collated screws, 1 bit 1/4" size 2 / Phillips (form H), long, 1 depth stop, 1 magnetic holder for bits 1/4", 1 bit 1/4" for cross-slotted screws size 2 / Phillips (form H) with dust-protection ring, 1 hand strap, 1 belt clip, 1 plastic carrying case

For accessories, see page 65

Autofeeder screwdriver for quick repeated screw fittings with quiet clutch.

Input	W	450
Output	W	250
Speed, full load	rpm	0 - 2,700
Speed, no load	rpm	0 - 4,000
Max. torque (hard/soft)	Nm	12 / -
Screw Ø	mm	5
Screw length	mm	25 - 55
Rapid change chuck		1/4"
Cable with plug	m	5
Weight according to EPTA	kg	1,6

Part number	7 213 06 50 01 8
EAN	4014586854205

FEIN BENEFITS

- + Drywall construction screwdriver SCT 5-40 X incl. magazine M55 X.
- + QuickIN for tool-free removal collated strips, setting of screw length and driving depth as well as quick cleaning.
- + Speed-optimised; for rapid fixing of plasterboard to wood or metal frames.
- + One of the lightest screwdrivers in its class.
- + Silent FEIN CLIC-STOP clutch.
- + Point placement accuracy with infinitely variable electronic speed setting.
- + Patented screw transport system.
- + Additional depth stop for non-collated screws.
- + Ideally suited for single-hand use.
- + Magazine can be rotated through 360 degrees.
- + Robust shell casing.
- + Market-leading ergonomics with FEIN Sensitive handle.
- + FEIN high-power motor.
- + Vibration-free stop.
- + Practical hand strap.

GENERAL ACCESSORIES



CORDLESS ALED 12-18 V LED LAMP

Compact and durable cordless LED lamp with swivel-mounted lamp head. Compatible with all 12 / 14 / 18 V FEIN Li-ion batteries, including hook for attaching the lamp. Extremely lightweight at 130 g and very bright at 900 Lux. Colour temperature is the equivalent of daylight. The brightness can be set to 2 levels.

Part number
9 26 04 200 02 0



AUSB 12-18 V CORDLESS USB ADAPTER

Compact cordless USB adapter for charging smartphones, tablets etc. without a mains connection. 2 high-speed USB charging ports for rapid charging at 2x 1.2 amps. Suitable for iOS and Android. Compatible with all 12 / 14 / 18 V FEIN Li-ion batteries.

Part number
9 26 04 201 02 0



TOOL CASE

Plastic, inner dimensions: 470 x 275 x 116 mm

Part number
3 39 01 118 01 0



PLASTIC BOX

Box insert with lockable lid for small parts and accessories, suitable for tool box 3 39 01 118 01 0, max 5 items/box.

Part number
3 39 01 119 00 0



QUICK CHARGER ALG 80 BC

Bluetooth® connectivity for connecting to a mobile end device and for use with the my.FEIN app. Shows the current charge state and the number of charge cycles to date on your smartphone or tablet. Provides notification when the battery is fully charged. Short charge times thanks to high charge current of 8 amps and process-controlled charge management. Large LED display with charge indicator and USB port for mobile charging of small electrical devices. For all FEIN Li-ion batteries. Charge times (80 % of max. capacity): 12 and 18 V / 3 Ah: 31 min., 12 and 18 V / 6 Ah: 38 min., 18 V / 5.2 Ah: 33 min.

Part number
9 26 04 210 01 0



TOOL HOLDER 1/4" EXTERNAL HEXAGON

1/4" Drive-Hex Socket with quick-change chuck

Ø mm	L mm	Part number
15	51	6 05 10 011 00 9



BIT, 1/4" HEXAGON HEAD

Form H/Phillips (pack of 5) extra hard, with dust protection ring

L mm	Size	Part number
25	2	6 27 12 109 03 4

18 V BATTERY



BATTERY PACK

Li-ion battery with charge status indicator and FEIN SafetyCell technology. Protects the battery and tool from overload, overheating and total discharge. Can be used with all FEIN 18 V cordless tools.

Current/Voltages V	Capacity Ah	Weight kg	Part number
18	6	0,7	9 26 04 175 02 0
18	3	0,45	9 26 04 182 02 0



BATTERY STARTER SET

2 x Li-ion batteries with ALG 80 BC rapid charger. Bluetooth® connectivity for connecting to a mobile end device and for use with the my.FEIN app. Shows the current charge state and the number of charge cycles to date on your smartphone or tablet. Provides notification when the battery is fully charged. Short charge times thanks to high charge current of 8 amps and process-controlled charge management. Large LED display with charge indicator and USB port for mobile charging of small electrical devices. For all FEIN Li-ion batteries. Charge times (80 % of max. capacity): 12 and 18 V / 3 Ah: 31 min., 12 and 18 V / 6 Ah: 38 min., 18 V / 5.2 Ah: 33 min.

Current/Voltages V	Capacity Ah	Part number
18	6	9 26 04 323 01 0
18	3	9 26 04 324 01 0

ACCESSORIES FOR AUTOFEED SCREWDRIVERS



M55 X MAGAZINE

for collated screws of 25 to 55 mm length and max. Ø 5 mm, tool-free changeover, weight 0.4 kg.

Part number
9 01 04 009 01 0



M55 X MAGAZINE EXTENSION WITH BELT GUIDE

Length 520 mm

Part number
9 01 04 010 01 0



BIT, 1/4" HEXAGON HEAD

for screwdriving into ceilings and floors
Form H/Phillips, size 2

Part number
6 05 03 306 00 8



HIGH-SPEED CONSTRUCTION SCREWS

Fine-pitch screw for fastening drywall to metal substructures, countersunk head, Ø 8 mm

Ø mm	L mm	No. in pack pcs	Part number
3,9	35	1 000	6 39 01 030 01 4
3,9	35	10 000	6 39 01 030 02 0



HIGH-SPEED CONSTRUCTION SCREWS

Coarse-pitch screw for fastening drywall to wood substructures, countersunk head, Ø 8 mm

Ø mm	L mm	No. in pack pcs	Part number
3,9	30	1 000	6 39 01 031 01 3
3,9	30	10 000	6 39 01 031 02 0
3,9	35	1 000	6 39 01 032 01 6
3,9	35	10 000	6 39 01 032 02 0
3,9	45	1 000	6 39 01 033 01 0
3,9	45	10 000	6 39 01 033 02 0



HIGH-SPEED CONSTRUCTION SCREWS

Double threaded with milled rib for fastening Fermacell panels to metal or wood substructures.

Ø mm	L mm	No. in pack pcs	Part number
3,9	30	1 000	6 39 01 034 01 8
3,9	30	10 000	6 39 01 034 02 0



HIGH-SPEED CONSTRUCTION SCREWS

Double threaded with milled rib for wood substructures.

Ø mm	L mm	No. in pack pcs	Part number
4,2	35	10 000	6 39 01 035 02 0



GRINDING

CORDLESS ANGLE GRINDER 68

Dust-resistant and powerful tools for effective work in assembly jobs.

COMPACT ANGLE GRINDERS 71

Three equipment lines, the same unbeatable quality - the right angle grinder for every job.

LONG-NECKED ANGLE GRINDER 83

Long-necked angle grinder with spindle M 14 for working in difficult-to-reach areas.

ANGLE GRINDERS 84

Superior performance, comfortable and optimum safety FEIN angle grinders for heavy-duty grinding and cutting work.

DIE GRINDERS 92

The specialist tools for use in metal working, for grinding, brushing, deburring and polishing.

HF-ANGLE GRINDER 100

The specialists in continuous use when cutting and roughing-down under tough environmental conditions.

HIGH FREQUENCY STRAIGHT GRINDERS 106

The specialists in continuous use when sanding and deburring under tough environmental conditions.

FREQUENCY CONVERTER 111



CCG 18-115 BL SELECT CCG 18-125 BL SELECT CCG 18-115 BLPD SELECT CCG 18-125 BLPD SELECT

Dust-resistant and powerful, compact cordless angle grinder for effective cutting, grinding and deburring work in assembly jobs.

Dust-resistant and powerful, compact cordless angle grinder with dead man's switch for effective cutting, grinding and deburring work in assembly jobs.

PAGE		69	69	70	70
Roughing-down		+	+	+	+
Deburring		++	++	++	++
Dividing		++	++	++	++
Brushing		+	+	+	+
Satin-finishing		++	++	++	++
Brake		•	•	•	•
Soft start		•	•	•	•
Restart protection		•	•	•	•
Blockage monitoring		•	•	•	•
Electronic overload protection		•	•	•	•
Electronic speed preselection		•	•	•	•
AutoStop dead man's switch				•	•
Battery voltage	V	18	18	18	18
Speed, no load	rpm	2,500 - 8,500	2,500 - 8,500	2,500 - 8,500	2,500 - 8,500
Grinding disc Ø	mm	115	125	115	125
Elast. Backing pad Ø	mm	115	125	115	125
Weight without storage battery	kg	1,95	1,95	1,95	1,95

+ suitability ++ optimal suitability • included

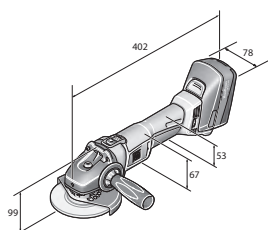

CCG 18-115 BL
CCG 18-125 BL

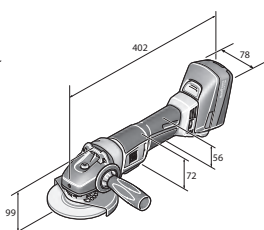

CCG 18-115 BLPD
CCG 18-125 BLPD

CCG 18-115 BL SELECT**CCG 18-125 BL SELECT**

Dust-resistant and powerful, compact cordless angle grinder for effective cutting, grinding and deburring work in assembly jobs.

Battery voltage	V	18	18
Battery compatibility		Li-ion/HighPower Li-ion**	Li-ion/HighPower Li-ion**
Battery interface		MultiVolt	MultiVolt
Motor		brushless	brushless
Speed, no load	rpm	2,500 - 8,500	2,500 - 8,500
Grinding disc Ø	mm	115	125
Elast. Backing pad Ø	mm	115	125
Flange		M 14	M 14
Weight without storage battery	kg	1,95	1,95

FEIN BENEFITS

- + Guarantees very long life with the next generation of brushless FEIN PowerDrive motors. Totally closed motor housing protects the motor from aggressive ceramic and mineral dusts.
 - + Ideal for every application. Optimum speeds, matched to a large number of abrasive materials and other materials using the infinitely variable, electronic speed preselection.
 - + Powerful. 30 % more efficiency than comparable universal motors with a rated output of 1100 W.
 - + Maintenance-free motor with innovative cooling ribs for optimum heat dissipation, including monitoring of temperature.
 - + Maximum work progress with FEIN HighPower Li-ion batteries. Cells capable of high currents with continually high power output and 75 % higher current rating than Li-ion batteries.
 - + Very smooth running and low-vibration working thanks to motor being decoupled from the housing and mounted separately and four additional vibration dampers.
 - + Extensive user protection features include soft start, restart protection, electronic overload protection and brake.
 - + Fatigue-free working thanks to narrow grip dimensions, compact design and a well-balanced low weight.
 - + Separate motor electronics with dust guard in handle area.
 - + Flexibility with the FEIN MultiVolt interface. Tool can be operated with all FEIN Li-ion batteries (12 to 18V).
 - + Safety hood, which can be adjusted without the use of tools, and quick-clamping nuts make for short setup times.
 - + Bright working area thanks to integrated LED light.
 - + Stackable tool case made from sturdy plastic and space for abrasive materials and accessories.
- ** Maximum performance with FEIN HighPower Li-ion battery.

SUPPLIED

1 wheel guard, 1 Tool-free quick-clamping nut, 1 anti-vibration handle, 1 key, 1 plastic carrying case

Part number	7 120 01 62 00 0	7 120 02 62 00 0
EAN	4014586888408	4014586888460

For accessories, see page 81

CCG 18-115 BLPD SELECT**CCG 18-125 BLPD SELECT**

Dust-resistant and powerful, compact cordless angle grinder with dead man's switch for effective cutting, grinding and deburring work in assembly jobs.

Battery voltage	V	18	18
Battery compatibility		Li-ion/HighPower Li-ion**	Li-ion/HighPower Li-ion**
Battery interface		MultiVolt	MultiVolt
Motor		brushless	brushless
Speed, no load	rpm	2,500 - 8,500	2,500 - 8,500
Grinding disc Ø	mm	115	125
Elast. Backing pad Ø	mm	115	125
Flange		M 14	M 14
Weight without storage battery	kg	1,95	1,95

FEIN BENEFITS

- + Guarantees very long life with the next generation of brushless FEIN PowerDrive motors. Totally closed motor housing protects the motor from aggressive ceramic and mineral dusts.
 - + Ideal for every application. Optimum speeds, matched to a large number of abrasive materials and other materials using the infinitely variable, electronic speed preselection.
 - + Powerful. 30 % more efficiency than comparable universal motors with a rated output of 1100 W.
 - + Maintenance-free motor with innovative cooling ribs for optimum heat dissipation, including monitoring of temperature.
 - + Maximum work progress with FEIN HighPower Li-ion batteries. Cells capable of high currents with continually high power output and 75 % higher current rating than Li-ion batteries.
 - + Very smooth running and low-vibration working thanks to motor being decoupled from the housing and mounted separately and four additional vibration dampers.
 - + Extensive user protection features include soft start, restart protection, electronic overload protection and brake.
 - + Secure hold for all applications thanks to non-slip handle.
 - + Fatigue-free working thanks to narrow grip dimensions, compact design and a well-balanced low weight.
 - + Separate motor electronics with dust guard in handle area.
 - + Flexibility with the FEIN MultiVolt interface. Tool can be operated with all FEIN Li-ion batteries (12 to 18V).
 - + Safety hood, which can be adjusted without the use of tools, and quick-clamping nuts make for short setup times.
 - + Bright working area thanks to integrated LED light.
 - + Stackable tool case made from sturdy plastic and space for abrasive materials and accessories.
- ** Maximum performance with FEIN HighPower Li-ion battery.

SUPPLIED

1 wheel guard, 1 Tool-free quick-clamping nut, 1 anti-vibration handle, 1 key, 1 plastic carrying case

Part number	7 120 03 62 00 0	7 120 04 62 00 0
EAN	4014586888514	4014586888576

For accessories, see page 81



WSG 7-115 **WSG 7-125** **WSG 8-115** **WSG 8-125** **WSG 11-125** **WSG 11-125 RT** **WSG 12-125 P**

Ergonomic 700 W compact angle grinder for light-duty sanding and cutting. Ergonomic 800 W compact angle grinder for deburring, sanding and cutting. Ergonomic 1 100 W compact angle grinder for deburring, sanding and cutting. Ergonomic 1 100 W compact angle grinder with FEIN ErgoGrip for fatigue-free working. Ergonomic 1 200 W compact angle grinder with high power reserve for effective sanding and cutting.

PAGE		74	74	75	75	76	76	76
Roughing-down		+	+	+	+	++	++	++
Deburring		+	+	++	++	+	+	+
Dividing		+	+	+	+	++	++	++
Brushing				+	+	++	+	++
POWERtronic tachometer electronics								•
Soft start								•
Restart protection		•	•	•	•	•		•
Blockage monitoring								•
Electronic overload protection								•
AutoStop dead man's switch							•	
Input	W	760	750	800	800	1 100	1 100	1 200
Speed, no load	rpm	12,500	12,000	11,000	11,000	11,000	11,000	11,000
Grinding disc Ø	mm	115	125	115	125	125	125	125
Elast. Backing pad Ø	mm	115	125	115	125	125	125	125
Weight according to EPTA	kg	1,7	1,8	2	2	2,1	2,4	2,1

+ suitability ++ optimal suitability • included

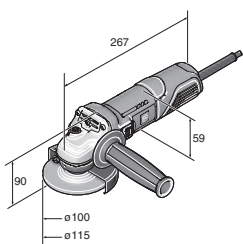

WSG 7-115
WSG 7-125

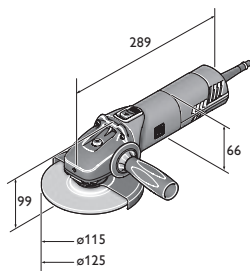

WSG 8-115
WSG 8-125
WSG 12-125 P
WSG 12-125 PQ



	WSG 15-125 P	WSG 15-125 PR	WSG 15-125 PRT	WSG 17-125 P	WSG 17-125 PS	WSG 17-150 P
	Ergonomic 1,500 W compact angle grinder with high power reserve for effective sanding and cutting.			Ergonomic compact angle grinder with high power reserve for effective sanding and cutting.	The specialist tool for serrated and fibre discs with extra high torque.	Ergonomic compact angle grinder with high power reserve for effective sanding and cutting.
PAGE	77	77	77	78	78	79
Roughing-down	++	++	++	++	++	++
Deburring	+	+	+	+	+	+
Dividing	++	++	++	++	+	++
Brushing	++	++	++	++	+	++
Satin-finishing						
Polishing						
POWERtronic tacho electronics	•	•	•	•	•	•
Soft start	•	•	•	•	•	•
Restart protection	•	•	•	•	•	•
Blockage monitoring	•	•	•	•	•	•
Electronic overload protection	•	•	•	•	•	•
Electronic speed preselection						
AutoStop dead man's switch				•		
Input	W	1 500	1 500	1 500	1 700	1 700
Speed, no load	rpm	11,000	11,000	11,000	11,000	8,500
Grinding disc Ø	mm	125	125	125	125	150
Elast. Backing pad Ø	mm	125	125	125	125	150
Weight according to EPTA	kg	2,3	2,4	2,4	2,3	2,4

+ suitability ++ optimal suitability • included

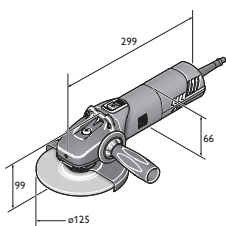

WSG 11-125
WSG 15-125 P
WSG 15-125 PQ
WSG 17-125 P
WSG 17-125 PQ

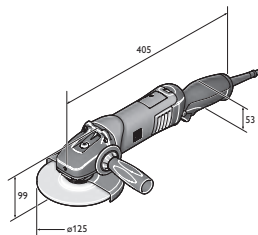

WSG 11-125 RT
WSG 15-125 PR
WSG 15-125 PRT
WSG 17-125 PR
WSG 17-125 PRT

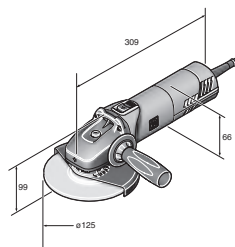

WSG 17-125 PS
WSG 17-70 Inox

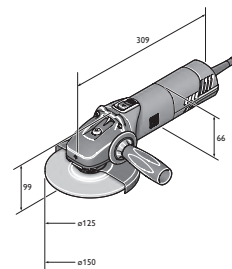

WSG 17-125 PSQ
WSG 17-150 P
WSG 17-150 PQ

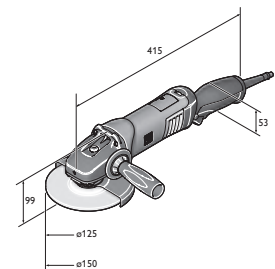

WSG 17-150 PR
WSG 17-150 PRT
WSG 17-70 Inox R
WSG 17-70 Inox RT



WSG 17-70 INOX	WSG 17-125 PR	WSG 17-125 PRT	WSG 17-150 PR	WSG 17-150 PRT	WSG 17-70 INOX R	WSG 17-70 INOX RT
----------------	---------------	----------------	---------------	----------------	------------------	-------------------

The specialist tool with variable speed for stainless steel processing.

Ergonomic compact angle grinder with FEIN ErgoGrip for fatigue-free working.

Ergonomic compact angle grinder with FEIN ErgoGrip for fatigue-free working in stainless steel applications.

	80	78	78	79	79	80	80
	++	++	++	++	++	++	++
	+	+	+	+	+	+	+
	+	++	++	++	++	+	+
	+	++	++	++	++	+	+
	++					++	++
	++					+	+
	•	•	•	•	•	•	•
	•	•	•	•	•	•	•
	•	•	•	•	•	•	•
	•	•	•	•	•	•	•
	•	•	•	•	•	•	•
	•					•	•
	954		•		•		•
	1 700	1 700	1 700	1 700	1 700	1 700	1 700
	2,700 - 8,500	11,000	11,000	8,500	8,500	2,700 - 8,500	2,700 - 8,500
	125	125	125	150	150	125	125
	125	125	125	150	150	125	125
	2,4	2,4	2,4	2,6	2,6	2,5	2,5

WSG 7-115**WSG 7-125**

Ergonomic 700 W compact angle grinder for light-duty sanding and cutting.

Input	W	760	750
Output	W	420	440
Speed, no load	rpm	12,500	12,000
Grinding disc Ø	mm	115	125
Elast. Backing pad Ø	mm	115	125
Flange		M 14	M 14
Cable with plug	m	2,5	4
Weight according to EPTA	kg	1,7	1,8

FEIN BENEFITS

- + Perfect ergonomics thanks to lateral slide switch and small grip dimension.
- + Fatigue-free working thanks to low weight.
- + Solid metal gearbox head can be turned in 90° steps for maximum robustness and service life and very good access to difficult-to-reach spots.
- + Enhanced safety through integrated restart protection.

SUPPLIED

1 wheel guard, 1 pair of flanges, 1 additional handle, 1 key

Part number	7 221 98 60 00 0	7 222 65 60 00 0
EAN	4014586885506	4014586891477

For accessories, see page 81

WSG 8-115**WSG 8-125**

Ergonomic 800 W compact angle grinder for deburring, sanding and cutting.

Input	W	800	800
Output	W	520	520
Speed, no load	rpm	11,000	11,000
Grinding disc Ø	mm	115	125
Elast. Backing pad Ø	mm	115	125
Flange		M 14	M 14
Cable with plug	m	4	4
Weight according to EPTA	kg	2	2

FEIN BENEFITS

- + Longer carbon brush life and tool removes more material than comparable angle grinders.
- + Solid metal gearbox head for maximum robustness and service life.
- + The lightest model of its kind.
- + H 07 industrial cable.
- + The best vibration performance in its class.
- + Safety hood can be adjusted without tools and has anti-twist protection.
- + Spindle lock.
- + Enhanced safety through integrated restart protection.

SUPPLIED

1 wheel guard, 1 pair of flanges, 1 additional handle, 1 key

Part number	7 221 73 60 00 0	7 221 74 60 00 0
EAN	4014586875033	4014586875125

For accessories, see page 81

WSG 11-125

Ergonomic 1 100 W compact angle grinder for deburring, sanding and cutting.

WSG 11-125 RT

Ergonomic 1 100 W compact angle grinder with FEIN ErgoGrip for fatigue-free working.

Input	W	1 100	1 100
Output	W	650	700
Speed, no load	rpm	11,000	11,000
Grinding disc Ø	mm	125	125
Elast. Backing pad Ø	mm	125	125
Flange		M 14	M 14
Cable with plug	m	4	4
Weight according to EPTA	kg	2,1	2,4

FEIN BENEFITS

- + Longer carbon brush life and tool removes more material than comparable angle grinders.
- + Solid metal gearbox head for maximum robustness and service life.
- + The lightest model of its kind.
- + H 07 industrial cable.
- + The best vibration performance in its class.
- + Safety hood can be adjusted without tools and has anti-twist protection.
- + Spindle lock.
- + Enhanced safety through integrated restart protection.
- + AutoStop dead man's switch.
- + FEIN ErgoGrip - Unique ergonomic concept for fatigue-free working (patent pending).

SUPPLIED

1 wheel guard, 1 pair of flanges, 1 additional handle, 1 key

Part number	7 221 77 60 00 0	7 221 87 60 00 0
EAN	4014586875316	4014586879888

For accessories, see page 81

WSG 12-125 P

Ergonomic 1 200 W compact angle grinder with high power reserve for effective sanding and cutting.

Input	W	1 200
Output	W	650
Speed, no load	rpm	11,000
Grinding disc Ø	mm	125
Elast. Backing pad Ø	mm	125
Flange		M 14
Cable with plug	m	4
Weight according to EPTA	kg	2,1

FEIN BENEFITS

- + Longer carbon brush life and tool removes more material than comparable angle grinders.
- + POWERtronic for enormous power, power reserve and exceptional speed stability under load.
- + User protection features include blockage monitoring, restart protection, soft start and electronic overload protection.
- + The lightest and shortest model of its kind.
- + Solid metal gearbox head.
- + H 07 industrial cable.
- + The best vibration performance in its class.

SUPPLIED

1 wheel guard, 1 pair of flanges,
1 anti-vibration handle, 1 key

For accessories, see page 81

Part number	7 221 75 60 00 0
EAN	4014586875217

You will find the Q variant (set with quick-clamping nut) of the tool in the numerical section.

WSG 15-125 P



WSG 15-125 PR



WSG 15-125 PRT



Ergonomic 1,500 W compact angle grinder with high power reserve for effective sanding and cutting.

Input	W	1 500	1 500	1 500
Output	W	900	900	900
Speed, no load	rpm	11,000	11,000	11,000
Grinding disc Ø	mm	125	125	125
Elast. Backing pad Ø	mm	125	125	125
Flange		M 14	M 14	M 14
Cable with plug	m	4	4	4
Weight according to EPTA	kg	2,3	2,4	2,4

FEIN BENEFITS	+ Longer carbon brush life and tool removes more material than comparable angle grinders.	+ FEIN ErgoGrip - Unique ergonomic concept for fatigue-free working (patent pending).
	+ POWERtronic for enormous power, power reserve and exceptional speed stability under load.	+ User protection features include blockage monitoring, restart protection, soft start and electronic overload protection.
	+ The lightest and shortest model of its kind.	+ The lightest model of its kind.
	+ Solid metal gearbox head.	
	+ H 07 industrial cable.	
	+ The best vibration performance in its class.	+ AutoStop dead man's switch.

SUPPLIED 1 wheel guard, 1 pair of flanges, 1 anti-vibration handle, 1 key

Part number	7 221 78 60 00 0	7 221 90 60 00 0	7 221 91 60 00 0
EAN	4014586875323	4014586879970	4014586880020

You will find the Q variant (set with quick-clamping nut) of the tool in the numerical section.

For accessories, see page 81

WSG 17-125 P

Ergonomic compact angle grinder with high power reserve for effective sanding and cutting.

WSG 17-125 PS

The specialist tool for serrated and fibre discs with extra high torque.

WSG 17-125 PR

Ergonomic compact angle grinder with FEIN ErgoGrip for fatigue-free working.

WSG 17-125 PRT

Input	W	1 700	1 700	1 700	1 700
Output	W	1 000	1 000	1 000	1 000
Speed, no load	rpm	11,000	8,500	11,000	11,000
Grinding disc Ø	mm	125	125	125	125
Elast. Backing pad Ø	mm	125	125	125	125
Flange		M 14	M 14	M 14	M 14
Cable with plug	m	4	4	4	4
Weight according to EPTA	kg	2,3	2,4	2,4	2,4
FEIN BENEFITS		<ul style="list-style-type: none"> + Longer carbon brush life and tool removes more material than comparable angle grinders. + POWERtronic for enormous power, power reserve and exceptional speed stability under load. + User protection features include blockage monitoring, restart protection, soft start and electronic overload protection. + The lightest and shortest model of its kind. + Solid metal gearbox head. + H 07 industrial cable. + The best vibration performance in its class. 		<ul style="list-style-type: none"> + FEIN ErgoGrip - Unique ergonomic concept for fatigue-free working (patent pending). + The lightest model of its kind. 	
			<ul style="list-style-type: none"> + Optimum speed and high torque, specially for serrated and fibre discs. 		<ul style="list-style-type: none"> + AutoStop dead man's switch.

SUPPLIED

1 wheel guard, 1 pair of flanges, 1 anti-vibration handle, 1 key

Part number	7 222 07 60 00 0	7 222 09 60 00 0	7 222 18 60 00 0	7 222 19 60 00 0
EAN	4014586883120	4014586883236	4014586883571	4014586883618

You will find the Q variant (set with quick-clamping nut) of the tool in the numerical section.

For accessories, see page 81

WSG 17-150 P



Ergonomic compact angle grinder with high power reserve for effective sanding and cutting.

WSG 17-150 PR



Ergonomic compact angle grinder with FEIN ErgoGrip for fatigue-free working.

WSG 17-150 PRT



Input	W	1 700	1 700	1 700
Output	W	1 000	1 000	1 000
Speed, no load	rpm	8,500	8,500	8,500
Grinding disc Ø	mm	150	150	150
Elast. Backing pad Ø	mm	150	150	150
Flange		M 14	M 14	M 14
Cable with plug	m	4	4	4
Weight according to EPTA	kg	2,4	2,6	2,6
FEIN BENEFITS		<ul style="list-style-type: none"> + Longer carbon brush life and tool removes more material than comparable angle grinders. + POWERtronic for enormous power, power reserve and exceptional speed stability under load. + User protection features include blockage monitoring, restart protection, soft start and electronic overload protection. + The lightest and shortest model of its kind. + Solid metal gearbox head. + H 07 industrial cable. + The best vibration performance in its class. 	<ul style="list-style-type: none"> + FEIN ErgoGrip - Unique ergonomic concept for fatigue-free working (patent pending). + The lightest model of its kind. 	<ul style="list-style-type: none"> + AutoStop dead man's switch.
SUPPLIED		1 wheel guard, 1 pair of flanges, 1 anti-vibration handle, 1 key		
Part number		7 222 11 60 00 0	7 222 20 60 00 0	7 222 21 60 00 0
EAN		4014586883366	4014586883656	4014586883694

You will find the Q variant (set with quick-clamping nut) of the tool in the numerical section.

For accessories, see page 81

WSG 17-70 INOX



The specialist tool with variable speed for stainless steel processing.

WSG 17-70 INOX R



Ergonomic compact angle grinder with FEIN ErgoGrip for fatigue-free working in stainless steel applications.

WSG 17-70 INOX RT



Input	W	1 700	1 700	1 700
Output	W	1 000	1 000	1 000
Speed, no load	rpm	2,700 - 8,500	2,700 - 8,500	2,700 - 8,500
Grinding disc Ø	mm	125	125	125
Elast. Backing pad Ø	mm	125	125	125
Flange		M 14	M 14	M 14
Cable with plug	m	4	4	4
Weight according to EPTA	kg	2,4	2,5	2,5

FEIN BENEFITS	<ul style="list-style-type: none"> + Variable speed allows various tools to be used for applications ranging from satin-finish to sanding stainless steel. + POWERtronic for enormous power, power reserve and exceptional speed stability under load. + User protection features include blockage monitoring, restart protection, soft start and electronic overload protection. + The lightest and shortest model of its kind. + Solid metal gearbox head. + H 07 industrial cable. + The best vibration performance in its class. + Longer carbon brush life and tool removes more material than comparable angle grinders. 	<ul style="list-style-type: none"> + FEIN ErgoGrip - Unique ergonomic concept for fatigue-free working (patent pending). + The lightest model of its kind. 	<ul style="list-style-type: none"> + AutoStop dead man's switch.
----------------------	--------------------------------------------------------------------------------------------------------------------------------------------------------------------------------------------------------------------------------------------------------------------------------------------------------------------------------------------------------------------------------------------------------------------------------------------------------------------------------------------------------------------------------------------------------------------------------------------------------------------------------------------------------------------------------------------------------------	------------------------------------------------------------------------------------------------------------------------------------------------------------------------------------	---------------------------------------------------------------------------------

SUPPLIED 1 wheel guard, 1 pair of flanges, 1 anti-vibration handle, 1 key

Part number	7 222 13 60 00 0	7 222 22 60 00 0	7 222 23 60 00 0
EAN	4014586883496	4014586883731	4014586883779

For accessories, see page 81

GENERAL ACCESSORIES



TOOL CASE

Plastic, inner dimensions: 470 x 275 x 116 mm

Part number
3 39 01 118 01 0



PLASTIC BOX

Box insert with lockable lid for small parts and accessories, suitable for tool box 3 39 01 118 01 0, max 5 items/box.

Part number
3 39 01 119 00 0



ANTI-VIBRATION HANDLE

M 8, vibration absorbing, to reduce the vibrations during longer jobs.

Part number
3 21 19 124 01 0



QUICK-CLAMPING NUT

M14, to change discs without need for tool, low height of just 8 mm

Part number
6 38 02 191 01 0



INNER FLANGE

Part number
6 38 01 182 01 0



THREADED FLANGE

M 14, for flexible grinding/cutting discs, fan-pattern grinding wheels and round brush

Part number
6 38 02 052 00 0



THREADED FLANGE

M 14, for elastic backing pad and for twisted steel wire brush

Part number
6 38 01 154 00 7



ELASTIC BACKING PAD

with flange M 14, for fibre sanding sheets Ø 125 mm

Ø mm	Part number
125	6 38 06 087 01 3



GRINDING DISC

For coarse sanding and machining a welded seam with a good service life. Can be used universally in steel and stainless steel. Stepped shape, inner diameter of 22.23 mm, maximum speed of 12 250 rpm, maximum working speed of 80 m/s.

Ø mm	Thickness mm	No. in pack pcs	Part number
125	6	10	6 37 03 005 01 0



CUTTING WHEEL

Perfect for dividing thin sheet metal, pipes and profiles. Precise and rapid cut with minimum effort and excellent service life. No rework or thermal discolouration on the workpiece. Can be used universally in steel and stainless steel. Straight shape, inner diameter of 22.23 mm, maximum speed of 12 250 rpm, maximum working speed of 80 m/s.

Ø mm	Thickness mm	No. in pack pcs	Part number
125	1	25	6 37 09 013 01 0



CUTTING WHEEL

For dividing sheet metal, pipes and profiles with good dividing speed and good service life. Can be used universally in steel and stainless steel. Stepped shape, inner diameter of 22.23 mm, maximum speed of 12 250 rpm, maximum working speed of 80 m/s.

Ø mm	Thickness mm	No. in pack pcs	Part number
125	2,5	25	6 37 09 014 01 0



FLAP WHEEL

Abrasive material made from zirconium corundum for excellent surface results with good sanding capacity, offering simple handling and few vibrations. Ideal for machining edges. Long service life with consistent quality of work. Can be used universally in steel and stainless steel. Conical shape, inner diameter of 22.23 mm, maximum speed of 12 250 rpm, maximum working speed of 80 m/s.

Grain	Ø mm	No. in pack pcs	Part number
40	125	10	6 37 30 022 01 0
60	125	10	6 37 30 023 01 0
80	125	10	6 37 30 024 01 0



FIBRE SANDING DISC

High-performance abrasive material made from zirconium corundum with a very good sanding capacity and service life. Can be used universally in steel and stainless steel.

Grain	Ø mm	No. in pack pcs	Part number
36	125	25	6 37 17 301 01 0
60	125	25	6 37 17 302 01 0
80	125	25	6 37 17 303 01 0



WORK GLOVES

Vibration-attenuating, certified according to EN 388/420, EN ISO 10819, EEC No. 0200, No. in pack 1 pair.

Size	Part number
9 L	3 21 73 003 00 3
10 XL	3 21 73 004 00 1
11 XXL	3 21 73 005 00 5



CORDLESS ALED 12-18 V LED LAMP

Compact and durable cordless LED lamp with swivel-mounted lamp head. Compatible with all 12 / 14 / 18 V FEIN Li-ion batteries, including hook for attaching the lamp. Extremely lightweight at 130 g and very bright at 900 Lux. Colour temperature is the equivalent of daylight. The brightness can be set to 2 levels.

Part number
9 26 04 200 02 0



AUSB 12-18 V CORDLESS USB ADAPTER

Compact cordless USB adapter for charging smartphones, tablets etc. without a mains connection. 2 high-speed USB charging ports for rapid charging at 2x 1.2 amps. Suitable for iOS and Android. Compatible with all 12 / 14 / 18 V FEIN Li-ion batteries.

Part number
9 26 04 201 02 0



QUICK CHARGER ALG 80 BC

Bluetooth® connectivity for connecting to a mobile end device and for use with the my.FEIN app. Shows the current charge state and the number of charge cycles to date on your smart-phone or tablet. Provides notification when the battery is fully charged. Short charge times thanks to high charge current of 8 amps and process-controlled charge management. Large LED display with charge indicator and USB port for mobile charging of small electrical devices. For all FEIN Li-ion batteries. Charge times (80 % of max. capacity): 12 and 18 V / 3 Ah: 31 min., 12 and 18 V / 6 Ah: 38 min., 18 V / 5.2 Ah: 33 min.

Part number
9 26 04 210 01 0

18 V BATTERY



HIGHPOWER BATTERY PACK

HighPower Li-ion battery with cells capable of handling high currents, charge status indicator and FEIN SafetyCell technology. Continually high power output with 75 % higher current rating than a Li-ion battery. Recommended for FEIN cordless magnetic core drills and cordless angle grinders. Can be used with all FEIN 18 V cordless tools.

Current/Voltages V	Capacity Ah	Weight kg	Part number
18	5,2	0,75	9 26 04 179 02 0



HIGHPOWER BATTERY STARTER SET

2 HighPower Li-ion batteries with ALG 80 rapid charger. Bluetooth® connectivity for connecting to a mobile end device and for use with the my.FEIN app. Shows the current charge state and the number of charge cycles to date on your smart-phone or tablet. Provides notification when the battery is fully charged. Short charge times thanks to high charge current of 8 amps and process-controlled charge management. Large LED display with charge indicator and USB port for mobile charging of small electrical devices. For all FEIN Li-ion batteries. Charge times (80 % of max. capacity): 12 and 18 V / 3 Ah: 31 min., 12 and 18 V / 6 Ah: 38 min., 18 V / 5.2 Ah: 33 min.

Current/Voltages V	Capacity Ah	Part number
18	5,2	9 26 04 325 01 0

PROTECTIVE COVERS



WHEEL GUARD

for serrated and roughing discs

Ø mm	Part number
115	3 18 10 299 00 0
125	3 18 10 300 00 0
150	3 18 10 301 00 0



SAFETY HOOD FOR CUTTING WORK

for safe working with cutting wheels

Ø mm	Part number
115	6 38 11 016 01 0
125	6 38 11 017 01 0
150	6 38 11 018 01 0

ACCESSORIES FOR THE WSG 7



WHEEL GUARD

for serrated and roughing discs

Ø mm	Part number
115	3 13 48 073 01 0
125	3 13 48 134 01 0



SAFETY HOOD FOR CUTTING WORK

for safe working with cutting wheels

Ø mm	Part number
115	3 13 48 135 01 0

MSFV 649-1

Long-necked angle grinder with spindle M 14 for working in difficult-to-reach areas.

SUPPLIED

1 wheel guard, 1 pair of flanges,
1 set of keys

For accessories, see page 83

Input	W	750
Output	W	480
Speed, no load	rpm	12,000
Grinding disc Ø	mm	125
Flange		M 14
Cable with plug	m	5
Weight according to EPTA	kg	4

FEIN BENEFITS

- + Very flat drive head to plunge a long way into workpieces.
- + Safe and comfortable handling thanks to convenient handle positions.
- + Wheel guard with protection against twisting.
- + AutoStop dead man's switch.

Part number	7 221 31 00 23 0
EAN	4014586858371

ACCESSORIES FOR MSFV 649-1

INNER FLANGE
for wheels Ø 125 mm

Part number
6 38 01 079 00 9

THREADED FLANGE
M 14, for wheels up to 6 mm

Part number
6 38 02 084 00 9



	WSG 20-180	WSB 20-180	WSB 20-180	WSG 20-230	WSG 20-230	WSB 20-230	WSB 20-230
	Powerful angle grinder for grinding work.	Powerful safety angle grinder for grinding work.		Powerful angle grinder for grinding and cutting work.		Powerful safety angle grinder for grinding and cutting work.	

PAGE		86	86	86	87	87	87	87
Roughing-down		++	++	++	++	++		
Deburring		+	+	+	+	+		
Dividing		+			+	+		
Brushing								
Brake			•	•			•	•
Soft start		•	•	•	•	•	•	•
Restart protection		•	•	•	•	•	•	•
AutoStop dead man's switch				•		•		•
FEIN high-power motor		•	•	•	•	•	•	•
Input	W	2 000	2 000	2 000	2 000	2 000	2 000	2 000
Speed, no load	rpm	8,500	8,500	8,500	6,600	6,600	6,600	6,600
Grinding disc Ø	mm	180	180	180	230	230	230	230
Tool Holder			QuickIN	QuickIN			QuickIN	QuickIN
Elast. Backing pad Ø	mm	180	180	180	230	230	230	230
Flange		M 14			M 14	M 14		
Weight according to EPTA	kg	5,6	5,9	5,9	5,6	5,6	5,9	5,9

+ suitability ++ optimal suitability • included

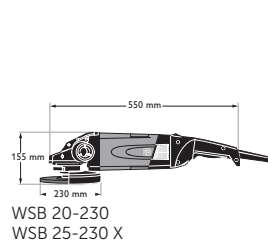
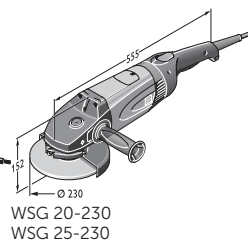
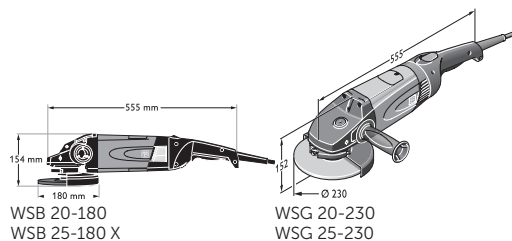
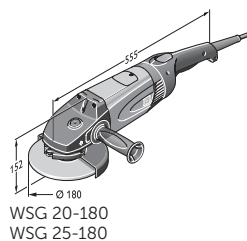



WSG 25-180	WSG 25-180	WSB 25-180 X	WSB 25-180 X	WSG 25-230	WSG 25-230	WSB 25-230 X	WSB 25-230 X
The most powerful FEIN angle grinder for extreme grinding work.		The most powerful FEIN safety angle grinder for extreme grinding work.		The most powerful FEIN angle grinder for extreme cutting and grinding work.		The most powerful FEIN safety angle grinder for extreme cutting and grinding work.	
88	88	88	88	89	89	89	89
++	++	++	++	+	+	+	+
+	+	+	+	+	+	+	+
				++	++	++	++
+	+						
		•	•			•	•
		•	•			•	•
		•	•			•	•
		•	•			•	•
		•	•			•	•
2 500	2 500	2 500	2 500	2 500	2 500	2 500	2 500
8,500	8,500	8,500	8,500	6,600	6,600	6,600	6,600
180	180	180	180	230	230	230	230
		QuickIN	QuickIN			QuickIN	QuickIN
180	180	180	180	230	230	230	230
M 14	M 14			M 14	M 14		
6,3	6,3	6,5	6,5	6,3	6,3	6,7	6,7

WSG 20-180**WSB 20-180****WSB 20-180**

Powerful angle grinder for grinding work.

Powerful safety angle grinder for grinding work.

Input	W	2 000	2 000	2 000
Output	W	1 250	1 250	1 250
Speed, no load	rpm	8,500	8,500	8,500
Grinding disc Ø	mm	180	180	180
Tool Holder	--	--	QuickIN	QuickIN
Mounting hole Ø	mm	--	22,23	22,23
Elast. Backing pad Ø	mm	180	180	180
Flange		M 14	--	--
Weight according to EPTA	kg	5,6	5,9	5,9
FEIN BENEFITS		<ul style="list-style-type: none"> + FEIN high-power motor - high sanding capacity over the full working range up to 150 % load. + Flat drive head allows the tool to be plunged into workpieces. + Soft start for safe handling from the word go. + Rear handle can be rotated through 4 positions. + Dustproof ball bearing. + Sealed electronic parts. + Carbon brushes with self cut-off function. + Restart protection. 	<ul style="list-style-type: none"> + FEIN high-power motor - effective material removal over the entire operating range. + Complete safety package with electronic brake system (EBS), restart lock and soft start. + Tool-free FEIN QuickIN clamping system safely clamps tools without a key. 	<ul style="list-style-type: none"> + AutoStop dead man's switch.
SUPPLIED		1 wheel guard, 1 pair of flanges, 1 additional handle, 1 key	1 wheel guard, 1 clamp for flexible grinding/cutting discs, 1 additional handle	
Part number		7 221 07 00 23 6	7 221 05 00 23 7	7 221 05 29 23 2
EAN		4014586851266	4014586851242	4014586851792

For accessories, see page 90

WSG 20-230

WSG 20-230

WSB 20-230

WSB 20-230



Powerful angle grinder for grinding and cutting work.

Powerful safety angle grinder for grinding and cutting work.

Input	W	2 000	2 000	2 000	2 000
Output	W	1 250	1 250	1 250	1 250
Speed, no load	rpm	6,600	6,600	6,600	6,600
Grinding disc Ø	mm	230	230	230	230
Tool Holder	--	--	--	QuickIN	QuickIN
Mounting hole Ø	mm	--	--	22,23	22,23
Elast. Backing pad Ø	mm	230	230	230	230
Flange		M 14	M 14	--	--
Weight according to EPTA	kg	5,6	5,6	5,9	5,9

FEIN BENEFITS

- | | | | |
|-------------------------------------------------------------------------------------------------------------------------------------------------------------------------------------------------------------------------------------------------------------------------------------------------------------------------------------------------------------------------------------------------------------------------------------------------------------------------------------------------------------|-----------------------------------------------------------------------------------------------------------------------------------------------------------------------------------------------------------------------------------|---------------------------------------------------------------------------------|---------------------------------------------------------------------------------|
| <ul style="list-style-type: none"> + FEIN high-power motor - high sanding capacity over the full working range up to 150 % load. + Flat drive head allows the tool to be plunged into work-pieces. + Soft start for safe handling from the word go. + Rear handle can be rotated through 4 positions. + Dustproof ball bearing. + Sealed electronic parts. + Carbon brushes with self cut-off function. + Restart protection. | <ul style="list-style-type: none"> + Complete safety package with electronic brake system (EBS), restart lock and soft start. + Tool-free FEIN QuickIN clamping system safely clamps tools without a key. | <ul style="list-style-type: none"> + AutoStop dead man's switch. | <ul style="list-style-type: none"> + AutoStop dead man's switch. |
|-------------------------------------------------------------------------------------------------------------------------------------------------------------------------------------------------------------------------------------------------------------------------------------------------------------------------------------------------------------------------------------------------------------------------------------------------------------------------------------------------------------|-----------------------------------------------------------------------------------------------------------------------------------------------------------------------------------------------------------------------------------|---------------------------------------------------------------------------------|---------------------------------------------------------------------------------|

SUPPLIED

1 wheel guard, 1 pair of flanges, 1 additional handle, 1 key	1 wheel guard, 1 clamp for flexible grinding/cutting discs, 1 additional handle
--------------------------------------------------------------	---------------------------------------------------------------------------------

Part number	7 221 08 00 23 2	7 221 08 29 23 7	7 221 06 00 23 0	7 221 06 29 23 5
EAN	4014586851273	4014586851853	4014586851259	4014586851815

For accessories, see page 90

WSG 25-180**WSG 25-180****WSB 25-180 X****WSB 25-180 X**

The most powerful FEIN angle grinder for extreme grinding work.

The most powerful FEIN safety angle grinder for extreme grinding work.

Input	W	2 500	2 500	2 500	2 500
Output	W	1 700	1 700	1 700	1 700
Speed, no load	rpm	8,500	8,500	8,500	8,500
Grinding disc Ø	mm	180	180	180	180
Tool Holder	--	--	--	QuickIN	QuickIN
Mounting hole Ø	mm	--	--	22,23	22,23
Elast. Backing pad Ø	mm	180	180	180	180
Flange	M 14	M 14	M 14	--	--
Weight according to EPTA	kg	6,3	6,3	6,5	6,5

FEIN BENEFITS

- + The 2,500 W FEIN high-power motor makes this the most powerful FEIN angle grinder with outstanding sanding capacity over the entire working range of up to 150 % load.
- + Flat drive head allows the tool to be plunged into workpieces.
- + Soft start for safe handling from the word go.
- + Rear handle can be rotated through 4 positions.
- + Dustproof ball bearing.
- + Sealed electronic parts.
- + Carbon brushes with self cut-off function.
- + Restart protection.
- + AutoStop dead man's switch.

- + Complete safety package with electronic brake system (EBS), restart lock and soft start.
- + Tool-free FEIN QuickIN clamping system safely clamps tools without a key.
- + AutoStop dead man's switch.

SUPPLIED

1 wheel guard, 1 pair of flanges, 1 additional handle, 1 key

1 wheel guard, 1 clamp for flexible grinding/cutting discs, 1 additional handle

Part number	7 221 26 00 23 0	7 221 26 29 23 0	7 221 10 00 23 3	7 221 10 29 23 8
EAN	4014586856452	4014586856490	4014586853116	4014586853246

For accessories, see page 90

WSG 25-230

WSG 25-230

WSB 25-230 X

WSB 25-230 X



The most powerful FEIN angle grinder for extreme cutting and grinding work.

The most powerful FEIN safety angle grinder for extreme cutting and grinding work.

Input	W	2 500	2 500	2 500	2 500
Output	W	1 700	1 700	1 700	1 700
Speed, no load	rpm	6,600	6,600	6,600	6,600
Grinding disc Ø	mm	230	230	230	230
Tool Holder	--	--	--	QuickIN	QuickIN
Mounting hole Ø	mm	--	--	22,23	22,23
Elast. Backing pad Ø	mm	230	230	230	230
Flange	M 14	M 14	M 14	--	--
Weight according to EPTA	kg	6,3	6,3	6,7	6,7

FEIN BENEFITS

- + The 2,500 W FEIN high-power motor makes this the most powerful FEIN angle grinder with outstanding sanding capacity over the entire working range of up to 150 % load.
 - + Flat drive head allows the tool to be plunged into complex workpieces.
 - + Soft start for safe handling from the word go.
 - + Rear handle can be rotated through 4 positions.
 - + Dustproof ball bearing.
 - + Sealed electronic parts.
 - + Carbon brushes with self cut-off function.
 - + Restart protection.
 - + AutoStop dead man's switch.
- + Complete safety package with electronic brake system (EBS), restart lock and soft start.
 - + Tool-free FEIN QuickIN clamping system safely clamps tools without a key.
 - + AutoStop dead man's switch.

SUPPLIED

1 key, 1 wheel guard, 1 pair of flanges, 1 additional handle

1 wheel guard, 1 clamp for flexible grinding/cutting discs, 1 additional handle

Part number	7 221 27 00 23 0	7 221 27 29 23 0	7 221 11 00 23 2	7 221 11 29 23 7
EAN	4014586856506	4014586856544	4014586853123	4014586853314

For accessories, see page 90

GENERAL ACCESSORIES



ANTI-VIBRATION HANDLE

M 14, vibration absorbing, to reduce the vibrations during longer jobs.

Part number

3 21 19 117 01 5



WORK GLOVES

Vibration-attenuating, certified according to EN 388/420, EN ISO 10819, EEC No. 0200, No. in pack 1 pair.

Size

Part number

9 L 3 21 73 003 00 3

10 XL 3 21 73 004 00 1

11 XXL 3 21 73 005 00 5



CONNECTING PIECE

Universal device to connect power tools and accessories with dust extraction to vacuum cleaner. Flexible rubber sleeve, length 70 mm, inner diameter 31.5 mm.

Part number

3 13 22 771 00 9

PROTECTIVE COVERS



SAFETY HOOD FOR CUTTING WORK

Ø
mm

Part number

180 6 38 11 004 01 0

230 6 38 11 005 01 0



PROTECTIVE SUCTION HOOD

with guide block for cutting discs Ø 180 mm cutting depth 40 mm, connection Ø 32 mm

Part number

9 06 04 008 01 3



PROTECTIVE SUCTION HOOD

with guide block for cutting discs Ø 230 mm cutting depth 65 mm, connection Ø 32 mm

Part number

9 06 04 009 01 7

ACCESSORIES FOR WSB



CLAMPING UNIT

for flexible grinding/cutting discs as well as for fan-pattern wheels

Part number

6 38 02 183 02 5



ELASTIC BACKING PAD

with clamping unit

Ø
mm

Part number

180 6 38 06 174 02 8



ELASTIC BACKING PAD

without clamping unit

Ø
mm

Part number

180 6 38 06 174 01 2



CLAMPING UNIT

for elastic backing pads

Part number

6 38 02 185 02 7

ACCESSORIES FOR WSG



THREADED FLANGE

M 14, for flexible grinding/cutting discs, fan-pattern grinding wheels and round brush

Part number

6 38 02 052 00 0



INNER FLANGE

Part number

6 38 01 182 01 0



ELASTIC BACKING PAD

with flange M 14

Ø
mm

Part number

180 6 38 06 034 01 7



THREADED FLANGE

M 14, for elastic backing pad and for twisted steel wire brush

Part number

6 38 01 154 00 7



	AGSZ 18-280 BL SELECT	AGSZ 18-280 LBL SELECT	AGSZ 18-90 LBL SELECT	GSZ 4-280 EL	GSZ 4-90 EL
	Dust-resistant and powerful, compact cordless die grinder for effective cutting, grinding, deburring and milling work.	Dust-resistant and powerful, compact cordless die grinder with large plunge depth for effective cutting, grinding, deburring and milling work.	Dust-resistant and powerful, compact cordless die grinder with large plunge depth for grinding and polishing work.	Extremely ergonomic die grinder with high plunge depth for light grinding and deburring in especially difficult-to-reach spots.	Extremely ergonomic die grinder for stainless steel processing with high plunge depth for light grinding and polishing in especially difficult-to-reach spots.
PAGE	94	94	94	95	95
Cutting	++	++		++	
Roughing-down	++	++		++	++
Grinding	++	++		++	
Deburring	+	+		+	
Dividing	+	+			
Brushing	+			+	++
Satin-finishing				++	++
Polishing				++	++
Long neck		•		•	•
Input	W			350	350
Battery voltage	V	18	18	18	
Battery compatibility		Li-ion/ HighPower Li-ion	Li-ion/ HighPower Li-ion	Li-ion/ HighPower Li-ion	
Speed, no load	rpm	9,000 - 28,000	9,000 - 28,000	2,900 - 9,000	13,000 - 28,000
Grinding wheel for max. Ø	mm	50	50	50	20
Collet for max. Ø	mm	8	8	8	6
Weight according to EPTA	kg				1,5
Weight without storage battery	kg	1,4	1,6	1,8	

+ suitability ++ optimal suitability • included

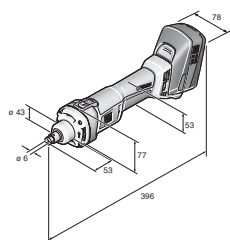

AGSZ 18-280 BL

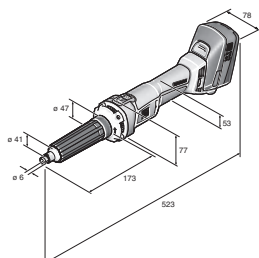

AGSZ 18-280 LBL

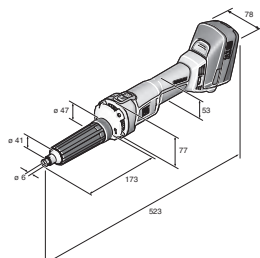

AGSZ 18-90 LBL

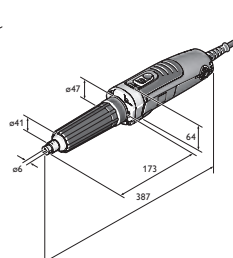

GSZ 4-280 EL

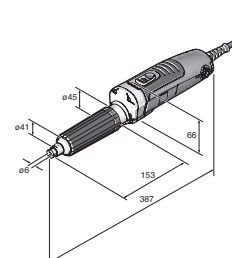

GSZ 4-90 EL



GSZ 8-280 P	GSZ 8-280 PE	GSZ 8-280 PEL	GSZ 8-90 PEL	GSZ 11-320 PERL	GSZ 11-90 PERL
Ergonomic, powerful die grinder for grinding and deburring in difficult-to-reach spots; also suitable for semi-stationary use.		Ergonomic, powerful die grinder with high plunge depth for grinding and deburring in difficult-to-reach spots.	Ergonomic, powerful die grinder for stainless steel processing with high plunge depth for grinding and polishing in especially difficult-to-reach spots.	Ergonomic, extremely powerful die grinder with high plunge depth for heavy-duty grinding and deburring in difficult-to-reach spots.	Ergonomic, extremely powerful die grinder for stainless steel processing with high plunge depth for heavy-duty grinding and polishing.
96	96	97	97	98	98
++	++	++	++	++	
	++	++		++	
++	++	++	++	++	++
	+	+		+	
					+
	+	+		++	++
				++	++
				++	++
		•	•	•	•
750	750	750	710	1 010	1 010
28,000	8,500 - 28,000	8,500 - 28,000	2,500 - 9,000	9,500 - 32,500	2,900 - 9,900
45	50	50	50	45	50
8	8	8	8	8	8
1,4	1,4	1,8	1,8	2,1	2,2

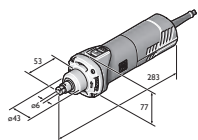

GSZ 8-280 P
GSZ 8-280 PE

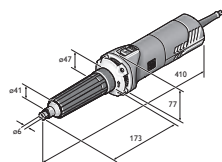

GSZ 8-280 PEL

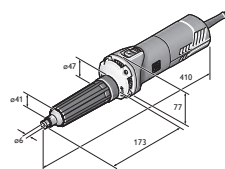

GSZ 8-90 PEL

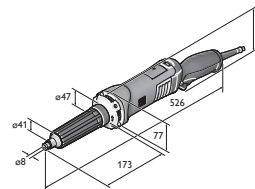

GSZ 11-320 PERL

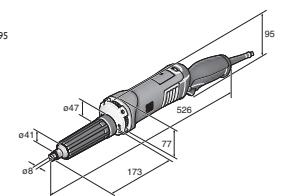

GSZ 11-90 PERL

**AGSZ 18-280 BL
SELECT**

Dust-resistant and powerful, compact cordless die grinder for effective cutting, grinding, deburring and milling work.

**AGSZ 18-280 LBL
SELECT**

Dust-resistant and powerful, compact cordless die grinder with large plunge depth for effective cutting, grinding, deburring and milling work.

**AGSZ 18-90 LBL
SELECT**

Dust-resistant and powerful, compact cordless die grinder with large plunge depth for grinding and polishing work.

Battery voltage	V	18	18	18
Battery compatibility		Li-ion/HighPower Li-ion	Li-ion/HighPower Li-ion	Li-ion/HighPower Li-ion
Battery interface		MultiVolt	MultiVolt	MultiVolt
Motor		brushless	brushless	brushless
Speed, no load	rpm	9,000 - 28,000	9,000 - 28,000	2,900 - 9,000
Polishing disc Ø	mm	--	--	80
Grinding wheel for max. Ø	mm	50	50	50
Collet for max. Ø	mm	8	8	8
Max. cutter diameter	mm	12	12	12
Weight without storage battery	kg	1,4	1,6	1,8

FEIN BENEFITS

- + Guarantees very long life with the next generation of brushless FEIN PowerDrive motors. Totally closed motor housing protects the motor from aggressive ceramic and mineral dusts.
- + Ideal for every application. Optimum speeds, matched to a large number of abrasive materials and other materials using the infinitely variable, electronic speed preselection.
- + Powerful. 30 % more efficiency than comparable universal motors with a rated output of 1100 W.
- + Maintenance-free motor with innovative cooling ribs for optimum heat dissipation, including monitoring of temperature.
- + Maximum work progress with FEIN HighPower Li-ion batteries. Cells capable of high currents with continually high power output and 75 % higher current rating than Li-ion batteries.
- + Very smooth running and low-vibration working thanks to motor being decoupled from the housing and mounted separately and four additional vibration dampers.
- + Extensive user protection features include soft start, restart protection and electronic overload protection.
- + Innovative collets with all-round flange to protect the workpiece and prevent the wrench sliding off during tool changes.
- + Fatigue-free working thanks to narrow grip dimensions, compact design and a well-balanced low weight.
- + Separate motor electronics with dust guard in handle area.
- + Flexibility with the FEIN MultiVolt interface. Tool can be operated with all FEIN Li-ion batteries (12 to 18V).
- + Bright working area thanks to integrated LED light.
- + Long, narrow neck allows tool to plunge a long way into workpieces (e.g. grinding inside pipes).
- + Removable rubber collar bearing cover.

SUPPLIED

1 collet Ø 6 mm, Jaw spanner SW13, Jaw spanner SW17, 1 plastic carrying case

Part number	7 123 01 62 00 0	7 123 02 62 00 0	7 123 03 62 00 0
EAN	4014586888637	4014586888699	4014586888750

For accessories, see page 99

GSZ 4-280 EL

Extremely ergonomic die grinder with high plunge depth for light grinding and deburring in especially difficult-to-reach spots.

GSZ 4-90 EL

Extremely ergonomic die grinder for stainless steel processing with high plunge depth for light grinding and polishing in especially difficult-to-reach spots.

Input	W	350	350
Output	W	170	170
Speed, no load	rpm	13,000 - 28,000	3,500 - 8,500
Polishing disc Ø	mm	--	50
Grinding wheel for max. Ø	mm	20	20
Collet for max. Ø	mm	6	6
Collar Ø	mm	43	--
Max. cutter diameter	mm	12	12
Cable with plug	m	5	5
Weight according to EPTA	kg	1,5	1,5

FEIN BENEFITS

- + Long narrow neck and maximum diameter of 210 mm allows tool to plunge a long way into workpieces (e.g. grinding inside pipes).
- + Innovative collets with all-round flange to protect the workpiece and prevent the wrench sliding off during tool changes.
- + Variable speed allows different tools to be used.
- + Motor and electronics protected against metal dust.
- + Removable rubber collar bearing cover.

SUPPLIED

1 collet Ø 6 mm, Jaw spanner SW13, Jaw spanner SW17

Jaw spanner SW17, 1 collet Ø 6 mm, Jaw spanner SW13

Part number	7 223 24 60 00 0	7 223 25 60 00 0
EAN	4014586880594	4014586880648

For accessories, see page 99

GSZ 8-280 P**GSZ 8-280 PE**

Ergonomic, powerful die grinder for grinding and deburring in difficult-to-reach spots; also suitable for semi-stationary use.

Input	W	750	750
Output	W	400	400
Speed, no load	rpm	28,000	8,500 - 28,000
Grinding wheel for max. Ø	mm	45	50
Collet for max. Ø	mm	8	8
Collar Ø	mm	43	43
Max. cutter diameter	mm	12	12
Cable with plug	m	4	4
Weight according to EPTA	kg	1,4	1,4

FEIN BENEFITS

- + Compact design for use in especially tight spaces, collar diameter of 43 mm for semi-stationary use as milling motor (e.g. as profile miller).
- + User protection features include blockage monitoring, restart protection, soft start and electronic overload protection.
- + Innovative collets with all-round flange to protect the workpiece and prevent the wrench sliding off during tool changes.
- + POWERtronic tachoelectronics for enormous power, power reserve and exceptional speed stability under load.
- + Motor and electronics protected against metal dust.

+ Variable speed allows different tools to be used.

SUPPLIED

1 collet Ø 6 mm, Jaw spanner SW13, Jaw spanner SW17

Part number	7 223 16 60 00 0	7 223 17 60 00 0
EAN	4014586879505	4014586879437

For accessories, see page 99

GSZ 8-280 PEL

Ergonomic, powerful die grinder with high plunge depth for grinding and deburring in difficult-to-reach spots.

GSZ 8-90 PEL

Ergonomic, powerful die grinder for stainless steel processing with high plunge depth for grinding and polishing in especially difficult-to-reach spots.

Input	W	750	710
Output	W	410	410
Speed, no load	rpm	8,500 - 28,000	2,500 - 9,000
Grinding wheel for max. Ø	mm	50	50
Collet for max. Ø	mm	8	8
Collar Ø	mm	43	43
Max. cutter diameter	mm	12	12
Cable with plug	m	4	4
Weight according to EPTA	kg	1,8	1,8

FEIN BENEFITS

- + Long narrow neck allows tool to plunge a long way into workpieces (e.g. grinding inside pipes).
- + User protection features include blockage monitoring, restart protection, soft start and electronic overload protection.
- + Innovative collets with all-round flange to protect the workpiece and prevent the wrench sliding off during tool changes.
- + POWERtronic tachoelectronics for enormous power, power reserve and exceptional speed stability under load.
- + Removable rubber collar bearing cover.
- + Motor and electronics protected against metal dust.
- + Variable speed allows different tools to be used.

SUPPLIED

1 collet Ø 6 mm, Jaw spanner SW13, Jaw spanner SW17

Part number	7 223 19 60 00 0	7 223 20 60 00 0
EAN	4014586879444	4014586879451

For accessories, see page 99

GSZ 11-320 PERL

Ergonomic, extremely powerful die grinder with high plunge depth for heavy-duty grinding and deburring in difficult-to-reach spots.

GSZ 11-90 PERL

Ergonomic, extremely powerful die grinder for stainless steel processing with high plunge depth for heavy-duty grinding and polishing.

Input	W	1 010	1 010
Output	W	620	620
Speed, no load	rpm	9,500 - 32,500	2,900 - 9,900
Polishing disc Ø	mm	--	80
Grinding wheel for max. Ø	mm	45	50
Collet for max. Ø	mm	8	8
Collar Ø	mm	43	43
Max. cutter diameter	mm	12	12
Cable with plug	m	4	4
Weight according to EPTA	kg	2,1	2,2

FEIN BENEFITS

- + Long narrow neck allows tool to plunge a long way into workpieces (e.g. grinding inside pipes).
- + User protection features include blockage monitoring, restart protection, soft start and electronic overload protection.
- + Innovative collets with all-round flange to protect the workpiece and prevent the wrench sliding off during tool changes.
- + POWERtronic tachoelectronics for enormous power, power reserve and exceptional speed stability under load.
- + Removable rubber collar bearing cover.
- + Motor and electronics protected against metal dust.
- + Variable speed allows different tools to be used.

SUPPLIED

1 collet Ø 8 mm, Jaw spanner SW13, Jaw spanner SW17

Part number	7 223 22 60 00 0	7 223 23 60 00 0
EAN	4014586880501	4014586880525

For accessories, see page 99

GENERAL ACCESSORIES



TOOL CASE

Plastic, inner dimensions: 470 x 275 x 116 mm

Part number
3 39 01 118 01 0



PLASTIC BOX

Box insert with lockable lid for small parts and accessories, suitable for tool box 3 39 01 118 01 0, max 5 items/box.

Part number
3 39 01 119 00 0



CORDLESS ALED 12-18 V LED LAMP

Compact and durable cordless LED lamp with swivel-mounted lamp head. Compatible with all 12 / 14 / 18 V FEIN Li-ion batteries, including hook for attaching the lamp. Extremely lightweight at 130 g and very bright at 900 Lux. Colour temperature is the equivalent of daylight. The brightness can be set to 2 levels.

Part number
9 26 04 200 02 0



AUSB 12-18 V CORDLESS USB ADAPTER

Compact cordless USB adapter for charging smartphones, tablets etc. without a mains connection. 2 high-speed USB charging ports for rapid charging at 2x 1.2 amps. Suitable for iOS and Android. Compatible with all 12 / 14 / 18 V FEIN Li-ion batteries.

Part number
9 26 04 201 02 0



QUICK CHARGER ALG 80 BC

Bluetooth® connectivity for connecting to a mobile end device and for use with the my.FEIN app. Shows the current charge state and the number of charge cycles to date on your smartphone or tablet. Provides notification when the battery is fully charged. Short charge times thanks to high charge current of 8 amps and process-controlled charge management. Large LED display with charge indicator and USB port for mobile charging of small electrical devices. For all FEIN Li-ion batteries. Charge times (80 % of max. capacity): 12 and 18 V / 3 Ah: 31 min., 12 and 18 V / 6 Ah: 38 min., 18 V / 5.2 Ah: 33 min.

Part number
9 26 04 210 01 0

18 V BATTERY



BATTERY PACK

Li-ion battery with charge status indicator and FEIN SafetyCell technology. Protects the battery and tool from overload, overheating and total discharge. Can be used with all FEIN 18 V cordless tools.

Current/Voltages V	Capacity Ah	Weight kg	Part number
18	6	0,7	9 26 04 175 02 0
18	3	0,45	9 26 04 182 02 0



BATTERY STARTER SET

2 x Li-ion batteries with ALG 80 BC rapid charger. Bluetooth® connectivity for connecting to a mobile end device and for use with the my.FEIN app. Shows the current charge state and the number of charge cycles to date on your smartphone or tablet. Provides notification when the battery is fully charged. Short charge times thanks to high charge current of 8 amps and process-controlled charge management. Large LED display with charge indicator and USB port for mobile charging of small electrical devices. For all FEIN Li-ion batteries. Charge times (80 % of max. capacity): 12 and 18 V / 3 Ah: 31 min., 12 and 18 V / 6 Ah: 38 min., 18 V / 5.2 Ah: 33 min.

Current/Voltages V	Capacity Ah	Part number
18	6	9 26 04 323 01 0
18	3	9 26 04 324 01 0

COLLETS FOR AGSZ 18, GSZ 4, GSZ 8, GSZ 11



COLLETS

With all-round flange to protect the workpiece and prevent the wrench sliding off during tool changes.

Ø	Part number
3 mm	6 32 07 130 00 0
6 mm	6 32 07 128 00 0
8 mm	6 32 07 129 00 0
1/4"	6 32 07 131 00 0



COLLETS INOX

Stainless steel model, with all-round flange to protect the workpiece and prevent the wrench sliding off during tool changes.

Ø	Part number
3 mm	6 32 07 132 00 0
6 mm	6 32 07 133 00 0
8 mm	6 32 07 134 00 0
1/4"	6 32 07 135 00 0



HFW 9-125 300 HZ 200 V	MSF 843-1C 300 HZ 200 V	MSFO 849-1C 300 HZ 200 V	MSFOV 852-1 300 HZ 200 V	MSFOV 852-1-180 300 HZ 200 V
Handy HF compact angle grinder for light-duty grinding and deburring work.	Powerful HF compact angle grinder for medium-duty grinding and deburring work.	Powerful HF angle grinder for medium-duty grinding work.	Long-neck HF angle grinder for hard-to-reach places.	

PAGE		102	102	102	103	103
Roughing-down			++		++	++
Deburring			+		+	+
Dividing			+			
Fully encapsulated motor				•	•	•
Input	W	900	1 100	1 500	1 900	1 900
Output	W	690	700	1 075	1 400	1 400
Frequency	Hz	300	300	300	300	300
Voltage/ type of current	V/3~	200	200	200	200	200
Speed, no load	rpm	7,100	6,500	6,150	8,800	7,450
Grinding disc Ø	mm	125	125	180	125	180
Elast. Backing pad Ø	mm	125	125	180		
Flange		M 14	M 14	M 14	M 14	M 14
Cable	m	5	5	5	5	5
Weight according to EPTA	kg	2,5	3,6	5,1	5,2	5,3

+ suitability ++ optimal suitability • included

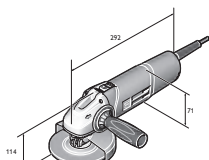

HFW 9-125



MSF 843-1c
MSFO 849-1c



MSFOV 852-1
MSFOV 852-1-180



MSFO 852-1c
MSFO 852-1d



MSFO 869-1c
MSFO 869-1d



MSFO 852-1C 300 HZ 200 V	MSFO 852-1D 300 HZ 200 V	MSFO 869-1C 300 HZ 200 V	MSFO 869-1D 300 HZ 200 V	MSFO 870-1C 300 HZ 200 V	MSFO 870-1D 300 HZ 200 V
Powerful HF angle grinder for medium- to heavy-duty grinding and brushing work.		Powerful HF angle grinder for heavy-duty cutting and grinding work.	Powerful HF angle grinder for heavy-duty grinding work.	The most powerful FEIN HF angle grinder for extreme cutting and grinding work.	The most powerful FEIN HF angle grinder for extreme grinding work.
103	103	104	104	105	105
++	++	++	++	++	++
+	+	+	+	+	+
+	+	++	+	++	+
•	•	•	•	•	•
1 900	1 900	3 100	3 100	3 700	3 700
1 400	1 400	2 450	2 450	2 800	2 800
300	300	300	300	300	300
200	200	200	200	200	200
6,400	8,500	6,500	8,600	6,600	8,600
230	180	230	180	230	180
180	180	180	180	180	180
M 14	M 14	M 14	M 14	M 14	M 14
5	5	5	5	5	5
6,3	5,9	7,7	7,4	8,5	8,2



MSfo 870-1c

MSfo 870-1d

HFW 9-125 300 HZ 200 V



SUPPLIED

1 wheel guard, 1 pair of flanges,
1 anti-vibration handle, 1 set of keys

For accessories, see page 114

Handy HF compact angle grinder for light-duty grinding and deburring work.

Input	W	900
Output	W	690
Frequency	Hz	300
Voltage/type of current	V/3~	200
Speed, no load	rpm	7,100
Grinding disc Ø	mm	125
Elast. Backing pad Ø	mm	125
Flange		M 14
Cable	m	5
Weight according to EPTA	kg	2,5

Part number	7 820 86 60 00 0
EAN	4014586869513

You will find other frequencies and voltages in the numerical section.

FEIN BENEFITS

- + Highly efficient compact angle grinder with the highest grinding capacity on the market.
- + Dust-proof, fully encapsulated switch for maximum service life.
- + Very thick-walled metal gearbox head made from cast aluminium for maximum stability and service life.
- + Perfect ergonomics with 2 handle zones and the smallest handle size for optimum handling even in continuous use.
- + Powerful ventilation.
- + Air escapes to the bottom.
- + High effective output.
- + Great speed consistency.
- + Low weight.

MSF 843-1C 300 HZ 200 V



SUPPLIED

1 wheel guard, 1 pair of flanges,
1 set of keys, 1 anti-vibration handle

For accessories, see page 114

Powerful HF compact angle grinder for medium-duty grinding and deburring work.

Input	W	1 100
Output	W	700
Frequency	Hz	300
Voltage/type of current	V/3~	200
Speed, no load	rpm	6,500
Grinding disc Ø	mm	125
Elast. Backing pad Ø	mm	125
Flange		M 14
Cable	m	5
Weight according to EPTA	kg	3,6

Part number	7 820 85 00 26 0
EAN	4014586864402

You will find other frequencies and voltages in the numerical section.

FEIN BENEFITS

- + Metal motor and gearbox housing for maximum load capacity in industrial continuous use.
- + Powerful ventilation for effective motor cooling.
- + Low-wear and low-maintenance.
- + Maximum reliability and outstanding service life.
- + High effective output.
- + Great speed consistency.

MSFO 849-1C 300 HZ 200 V



SUPPLIED

1 anti-vibration handle, 1 set of keys,
1 wheel guard, 1 pair of flanges

For accessories, see page 114

Powerful HF angle grinder for medium-duty grinding work.

Input	W	1 500
Output	W	1 075
Frequency	Hz	300
Voltage/type of current	V/3~	200
Speed, no load	rpm	6,150
Grinding disc Ø	mm	180
Elast. Backing pad Ø	mm	180
Flange		M 14
Cable	m	5
Weight according to EPTA	kg	5,1

Part number	7 820 80 00 26 0
EAN	4014586857145

You will find other frequencies and voltages in the numerical section.

FEIN BENEFITS

- + Metal motor and gearbox housing for maximum load capacity in industrial continuous use.
- + Fully encapsulated motor, 100% dust protection with surface cooling for maximum stability and service life even under extreme conditions of use.
- + Low-wear and low-maintenance.
- + Maximum reliability and outstanding service life.
- + High effective output.
- + Great speed consistency.

MSFOV 852-1 300 HZ 200 V**MSFOV 852-1-180 300 HZ 200 V**

Long-neck HF angle grinder for hard-to-reach places.

Input	W	1 900	1 900
Output	W	1 400	1 400
Frequency	Hz	300	300
Voltage/type of current	V/3~	200	200
Speed, no load	rpm	8,800	7,450
Grinding disc Ø	mm	125	180
Flange		M 14	M 14
Cable	m	5	5
Weight according to EPTA	kg	5,2	5,3

FEIN BENEFITS

- + Low profile gearbox head 65 mm in height, including grinding disc.
- + Metal motor and gearbox housing for maximum load capacity in industrial continuous use.
- + Fully encapsulated motor, 100% dust protection with surface cooling for maximum stability and service life even under extreme conditions of use.
- + Low-wear and low-maintenance.
- + Maximum reliability and outstanding service life.
- + High effective output.
- + Great speed consistency.

SUPPLIED

1 wheel guard, 1 pair of flanges, 1 set of keys

Part number	7 820 83 00 26 0	7 820 87 60 00 0
EAN	4014586857336	4014586886022

You will find other frequencies and voltages in the numerical section.

For accessories, see page 114

MSFO 852-1C 300 HZ 200 V**MSFO 852-1D 300 HZ 200 V**

Powerful HF angle grinder for medium- to heavy-duty grinding and brushing work.

Input	W	1 900	1 900
Output	W	1 400	1 400
Frequency	Hz	300	300
Voltage/type of current	V/3~	200	200
Speed, no load	rpm	6,400	8,500
Grinding disc Ø	mm	230	180
Elast. Backing pad Ø	mm	180	180
Flange		M 14	M 14
Cable	m	5	5
Weight according to EPTA	kg	6,3	5,9

FEIN BENEFITS

- + Metal motor and gearbox housing for maximum load capacity in industrial continuous use.
- + Fully encapsulated motor, 100% dust protection with surface cooling for maximum stability and service life even under extreme conditions of use.
- + Low-wear and low-maintenance.
- + Maximum reliability and outstanding service life.
- + High effective output.
- + Great speed consistency.

SUPPLIED

1 wheel guard, 1 pair of flanges, 1 set of keys, 1 anti-vibration handle

Part number	7 820 71 00 26 0	7 820 73 00 26 0
EAN	4014586856933	4014586856971

You will find other frequencies and voltages in the numerical section.

For accessories, see page 114

MSFO 869-1C 300 HZ 200 V

Powerful HF angle grinder for heavy-duty cutting and grinding work.

MSFO 869-1D 300 HZ 200 V

Powerful HF angle grinder for heavy-duty grinding work.

Input	W	3 100	3 100
Output	W	2 450	2 450
Frequency	Hz	300	300
Voltage/type of current	V/3~	200	200
Speed, no load	rpm	6,500	8,600
Grinding disc Ø	mm	230	180
Elast. Backing pad Ø	mm	180	180
Flange		M 14	M 14
Cable	m	5	5
Weight according to EPTA	kg	7,7	7,4

FEIN BENEFITS

- + Metal motor and gearbox housing for maximum load capacity in industrial continuous use.
- + Fully encapsulated motor, 100% dust protection with surface cooling for maximum stability and service life even under extreme conditions of use.
- + Low-wear and low-maintenance.
- + Maximum reliability and outstanding service life.
- + High effective output.
- + Great speed consistency.

SUPPLIED

1 wheel guard, 1 pair of flanges, 1 set of keys, 1 anti-vibration handle

Part number	7 820 62 00 26 0	7 820 65 00 26 0
EAN	4014586856759	4014586856834

You will find other frequencies and voltages in the numerical section.

For accessories, see page 114

MSFO 870-1C 300 HZ 200 V

The most powerful FEIN HF angle grinder for extreme cutting and grinding work.

MSFO 870-1D 300 HZ 200 V

The most powerful FEIN HF angle grinder for extreme grinding work.

Input	W	3 700	3 700
Output	W	2 800	2 800
Frequency	Hz	300	300
Voltage/type of current	V/3~	200	200
Speed, no load	rpm	6,600	8,600
Grinding disc Ø	mm	230	180
Elast. Backing pad Ø	mm	180	180
Flange		M 14	M 14
Cable	m	5	5
Weight according to EPTA	kg	8,5	8,2

FEIN BENEFITS

- + Metal motor and gearbox housing for maximum load capacity in industrial continuous use.
- + Fully encapsulated motor, 100% dust protection with surface cooling for maximum stability and service life even under extreme conditions of use.
- + Low-wear and low-maintenance.
- + Maximum reliability and outstanding service life.
- + High effective output.
- + Great speed consistency.

SUPPLIED

1 wheel guard, 1 pair of flanges, 1 set of keys, 1 anti-vibration handle

Part number	7 820 75 00 26 0	7 820 77 00 26 0
EAN	4014586857053	4014586857107

You will find other frequencies and voltages in the numerical section.

For accessories, see page 114



MSHYO 869-1A 300 HZ 200 V	MSHYO 869-1D 300 HZ 200 V	MSHYO 852-4A 300 HZ 200 V	MSHYO 852-3A 300 HZ 200 V
The most powerful FEIN HF straight grinder for satin-finishing work with large tools.	The most powerful FEIN HF straight grinder for heavy-duty grinding work.	Powerful HF straight grinder for satin-finishing work.	Powerful HF straight grinder for medium- to heavy-duty grinding work.

PAGE		108	108	108	109
Cutting					
Roughing-down			++		++
Deburring					
Satin-finishing		++		++	
Fully encapsulated motor		•	•	•	•
Input	W	3 100	3 100	1 900	1 900
Output	W	2 450	2 410	1 400	1 400
Frequency	Hz	300	300	300	300
Voltage/type of current	V/3~	200	200	200	200
Speed, no load	rpm	5,000	10,200	5,800	10,200
Flange		M 16	M 16	M 12	M 12
Grinding wheel for max. Ø	mm				
Collet for max. Ø	mm				
Cable	m	5	5	5	5
Weight according to EPTA	kg	8,9	8,9	5,7	5,2

+ suitability ++ optimal suitability • included



MShyo 869-1a
MShyo 869-1d

MShyo 852-4a

MShyo 852-3a
MSho 852-1

MSho 840-2

MSh 843-1



MSHO 852-1 300 HZ 200 V	MSHO 840-2 300 HZ 200 V	MSH 843-1 300 HZ 200 V	MSHO 849-1z 300 HZ 200 V
Powerful HF straight grinder for medium-duty to heavy-duty high-speed grinding work.	Handy HF straight grinder for light-duty grinding work.	Lightweight and handy HF straight grinder for milling work.	Powerful HF straight grinder for medium-duty grinding work with pin tools.
109	109	110	110
	+	++	
++	++		++
+			
+			
•	•	•	•
1 900	410	1 100	1 500
1 400	290	700	1 075
300	300	300	300
200	200	200	200
18,000	18,000	18,000	18,000
M 12			
	50	40	50
	6	6	8
5	5	5	5
5,2	2,1	3	3,9



MSho 849-1z

MSHYO 869-1A 300 HZ 200 V



SUPPLIED

1 wheel guard, 1 set of keys,
1 pair of flanges

For accessories, see page 114

The most powerful FEIN HF straight grinder for satin-finishing work with large tools.

Input	W	3 100
Output	W	2 450
Frequency	Hz	300
Voltage/type of current	V/3~	200
Speed, no load	rpm	5,000
Flange		M 16
Grinding wheel for max. Ø x width	mm	175 x 40
Cable	m	5
Weight according to EPTA	kg	8,9

Part number	7 824 37 00 26 0
EAN	4014586857633

You will find other frequencies and voltages in the numerical section.

FEIN BENEFITS

- + Ideal power/weight ratio and excellent efficiency.
- + Metal motor and gearbox housing for maximum load capacity in industrial continuous use.
- + Fully encapsulated motor, 100% dust protection with surface cooling for maximum stability and service life even under extreme conditions of use.
- + Powerful motor.
- + Extremely quiet running.
- + Low-wear and low-maintenance.
- + Maximum reliability and outstanding service life.
- + High effective output.
- + Great speed consistency.

MSHYO 869-1D 300 HZ 200 V



SUPPLIED

1 wheel guard, 1 set of keys,
1 pair of flanges

For accessories, see page 114

The most powerful FEIN HF straight grinder for heavy-duty grinding work.

Input	W	3 100
Output	W	2 410
Frequency	Hz	300
Voltage/type of current	V/3~	200
Speed, no load	rpm	10,200
Flange		M 16
Grinding wheel for max. Ø x width	mm	150 x 32
Cable	m	5
Weight according to EPTA	kg	8,9

Part number	7 824 38 00 26 0
EAN	4014586858111

You will find other frequencies and voltages in the numerical section.

FEIN BENEFITS

- + Ideal power/weight ratio and excellent efficiency.
- + Metal motor and gearbox housing for maximum load capacity in industrial continuous use.
- + Fully encapsulated motor, 100% dust protection with surface cooling for maximum stability and service life even under extreme conditions of use.
- + Powerful motor.
- + Extremely quiet running.
- + Low-wear and low-maintenance.
- + Maximum reliability and outstanding service life.
- + High effective output.
- + Great speed consistency.

MSHYO 852-4A 300 HZ 200 V



SUPPLIED

1 wheel guard, 1 pair of flanges,
1 set of keys

For accessories, see page 114

Powerful HF straight grinder for satin-finishing work.

Input	W	1 900
Output	W	1 400
Frequency	Hz	300
Voltage/type of current	V/3~	200
Speed, no load	rpm	5,800
Flange		M 12
Grinding wheel for max. Ø x width	mm	125 x 32/26
Cable	m	5
Weight according to EPTA	kg	5,7

Part number	7 824 40 00 26 0
EAN	4014586858180

You will find other frequencies and voltages in the numerical section.

FEIN BENEFITS

- + Powerful for high grinding capacity.
- + Metal motor and gearbox housing for maximum load capacity in industrial continuous use.
- + Fully encapsulated motor, 100% dust protection with surface cooling for maximum stability and service life even under extreme conditions of use.
- + Extremely quiet running.
- + High effective output.
- + Maximum reliability and outstanding service life.
- + Low-wear and low-maintenance.
- + Great speed consistency.

MSHYO 852-3A 300 HZ 200 V



SUPPLIED

1 wheel guard, 1 set of keys,
1 pair of flanges

For accessories, see page 114

Powerful HF straight grinder for medium- to heavy-duty grinding work.

Input	W	1 900
Output	W	1 400
Frequency	Hz	300
Voltage/type of current	V/3~	200
Speed, no load	rpm	10,200
Flange		M 12
Grinding wheel for max. Ø x width	mm	125 x 32/26
Cable	m	5
Weight according to EPTA	kg	5,2

Part number	7 824 39 00 26 0
EAN	4014586857657

You will find other frequencies and voltages in the numerical section.

FEIN BENEFITS

- + Powerful for high grinding capacity.
- + Metal motor and gearbox housing for maximum load capacity in industrial continuous use.
- + Fully encapsulated motor, 100% dust protection with surface cooling for maximum stability and service life even under extreme conditions of use.
- + Extremely quiet running.
- + Low-wear and low-maintenance.
- + Maximum reliability and outstanding service life.
- + High effective output.
- + Great speed consistency.

MSHO 852-1 300 HZ 200 V



SUPPLIED

1 set of keys, 1 pair of flanges,
1 wheel guard

For accessories, see page 114

Powerful HF straight grinder for medium-duty to heavy-duty high-speed grinding work.

Input	W	1 900
Output	W	1 400
Frequency	Hz	300
Voltage/type of current	V/3~	200
Speed, no load	rpm	18,000
Flange		M 12
Grinding wheel for max. Ø x width	mm	85 x 32/28
Cable	m	5
Weight according to EPTA	kg	5,2

Part number	7 824 42 00 26 0
EAN	4014586858241

You will find other frequencies and voltages in the numerical section.

FEIN BENEFITS

- + Ideal power/weight ratio and excellent efficiency.
- + Metal motor and gearbox housing for maximum load capacity in industrial continuous use.
- + Fully encapsulated motor, 100% dust protection with surface cooling for maximum stability and service life even under extreme conditions of use.
- + Extremely quiet running.
- + Low-wear and low-maintenance.
- + Maximum reliability and outstanding service life.
- + High effective output.
- + Great speed consistency.

MSHO 840-2 300 HZ 200 V



SUPPLIED

1 collet Ø 6 mm, 1 set of keys

For accessories, see page 114

Handy HF straight grinder for light-duty grinding work.

Input	W	410
Output	W	290
Frequency	Hz	300
Voltage/type of current	V/3~	200
Speed, no load	rpm	18,000
Grinding wheel for max. Ø	mm	50
Collet for max. Ø	mm	6
Cable	m	5
Weight according to EPTA	kg	2,1

Part number	7 823 03 00 26 0
EAN	4014586827636

You will find other frequencies and voltages in the numerical section.

FEIN BENEFITS

- + Split grinding spindle with multiple mountings for absolutely precise and vibration-free concentricity.
- + Metal motor and gearbox housing for maximum load capacity in industrial continuous use.
- + Fully encapsulated motor, 100% dust protection with surface cooling for maximum stability and service life even under extreme conditions of use.
- + Low-wear and low-maintenance.
- + Maximum reliability and outstanding service life.
- + High effective output.
- + Great speed consistency.

MSH 843-1 300 HZ 200 V



SUPPLIED

1 collet Ø 6 mm, 1 set of keys

For accessories, see page 114

Lightweight and handy HF straight grinder for milling work.

Input	W	1 100
Output	W	700
Frequency	Hz	300
Voltage/type of current	V/3~	200
Speed, no load	rpm	18,000
Grinding wheel for max. Ø	mm	40
Collet for max. Ø	mm	6
Cable	m	5
Weight according to EPTA	kg	3

Part number	7 823 19 00 26 0
EAN	4014586857947

You will find other frequencies and voltages in the numerical section.

FEIN BENEFITS

- + Powerful ventilation for effective motor cooling.
- + Split grinding spindle with multiple mountings for absolutely precise and vibration-free concentricity.
- + Metal motor and gearbox housing for maximum load capacity in industrial continuous use.
- + Low-wear and low-maintenance.
- + Maximum reliability and outstanding service life.
- + High effective output.
- + Great speed consistency.

MSHO 849-1Z 300 HZ 200 V



SUPPLIED

1 collet Ø 8 mm, 1 set of keys

For accessories, see page 114

Powerful HF straight grinder for medium-duty grinding work with pin tools.

Input	W	1 500
Output	W	1 075
Frequency	Hz	300
Voltage/type of current	V/3~	200
Speed, no load	rpm	18,000
Grinding wheel for max. Ø	mm	50
Collet for max. Ø	mm	8
Cable	m	5
Weight according to EPTA	kg	3,9

Part number	7 823 20 00 26 0
EAN	4014586858012

You will find other frequencies and voltages in the numerical section.

FEIN BENEFITS

- + Powerful for high grinding capacity.
- + Split grinding spindle with multiple mountings for absolutely precise and vibration-free concentricity.
- + Metal motor and gearbox housing for maximum load capacity in industrial continuous use.
- + Low-wear and low-maintenance.
- + Maximum reliability and outstanding service life.
- + High effective output.
- + Great speed consistency.



MO83-11KSR 50400
300 HZ 200 V

MO83-20KSR 50400
300 HZ 200 V

MO83-30KSR 50400
300 HZ 200 V

MO83-45KSR 50400
300 HZ 200 V

		112	112	113	113
PAGE					
Primary voltage	V	200	200	200	200
Output power	W	11	20	30	45
Motor power	W	11,6	20	28	41
Motor current (400 V)	A	21,4	34,2	49,4	75,1

MO83-11KSR 50400 300 HZ 200 V



For accessories, see page 114

Primary voltage	V	200
Output power	W	11
Motor power	W	11,6
Motor current (400 V)	A	21,4
Power consumption	W	14,9
Idling power	W	1,4
Length x height	mm	844 x 360

Part number	9 28 21 340 26 0
EAN	4014586845593

You will find other frequencies and voltages in the numerical section.

MO83-20KSR 50400 300 HZ 200 V



For accessories, see page 114

Primary voltage	V	200
Output power	W	20
Motor power	W	20
Motor current (400 V)	A	34,2
Power consumption	W	23,8
Idling power	W	2,8
Length x height	mm	1 058 x 416

Part number	9 28 28 340 26 6
EAN	4014586845791

You will find other frequencies and voltages in the numerical section.

MO83-30KSR 50400 300 HZ 200 V



For accessories, see page 114

Primary voltage	V	200
Output power	W	30
Motor power	W	28
Motor current (400 V)	A	49,4
Power consumption	W	34,4
Idling power	W	3,7
Length x height	mm	1 058 x 416

Part number	9 28 24 340 26 2
EAN	4014586845715

You will find other frequencies and voltages in the numerical section.

MO83-45KSR 50400 300 HZ 200 V



For accessories, see page 114

Primary voltage	V	200
Output power	W	45
Motor power	W	41
Motor current (400 V)	A	75,1
Power consumption	W	52,1
Idling power	W	5,4
Length x height	mm	1 252 x 463

Part number	9 28 26 340 26 8
EAN	4014586845746

You will find other frequencies and voltages in the numerical section.

GENERAL ACCESSORIES FOR HF TOOLS



ANTI-VIBRATION HANDLE
M 8, vibration absorbing, to reduce the vibrations during longer jobs.

Part number
3 21 19 124 01 0



ANTI-VIBRATION HANDLE
M 10, vibration absorbing, to reduce the vibrations during longer jobs.

Part number
3 21 19 118 01 3



ANTI-VIBRATION HANDLE
M 14, vibration absorbing, to reduce the vibrations during longer jobs.

Part number
3 21 19 117 01 5



MALE CONNECTOR
over 50 V, 16 A, 100 - 300 Hz, 10 h, 3 P+E

Part number
3 07 28 123 00 7



MALE CONNECTOR
over 50 V, 32 A, 100 - 300 Hz, 10 h, 3 P+E

Part number
3 07 28 124 00 5



SLEEVE PLUG
over 50 V, 16 A, 100 - 300 Hz, 10 h, 3 P+E

Part number
3 07 28 130 00 0



SLEEVE PLUG
over 50 V, 32 A, 100 - 300 Hz, 10 h, 3 P+E

Part number
3 07 28 131 00 9



MOTOR PROTECTION PLUG
FEIN's motor safety plugs provide reliable overload protection for high-frequency power tools. A bimetallic actuator, which is individually set to the corresponding rated current of the connected high-frequency tool, prevents premature or late activation in the event of brief overloading. The motor safety plug is fitted on the high-frequency power tool's connector cable instead of the normal male connector. The motor safety plug consists of a CEE plug, thermal actuators with temperature compensation and a rotary activation toggle. suited to the 840 series, setting range 1.6 - 2.5 A

Model	Part number
16 A	3 07 56 085 00 2
32 A	3 07 56 093 00 9



MOTOR PROTECTION PLUG
FEIN's motor safety plugs provide reliable overload protection for high-frequency power tools. A bimetallic actuator, which is individually set to the corresponding rated current of the connected high-frequency tool, prevents premature or late activation in the event of brief overloading. The motor safety plug is fitted on the high-frequency power tool's connector cable instead of the normal male connector. The motor safety plug consists of a CEE plug, thermal actuators with temperature compensation and a rotary activation toggle. suited to the HF 9, 843, 849 series, setting range 4 - 6.3 A

Model	Part number
16 A	3 07 56 087 00 9
32 A	3 07 56 095 00 1



MOTOR PROTECTION PLUG
FEIN's motor safety plugs provide reliable overload protection for high-frequency power tools. A bimetallic actuator, which is individually set to the corresponding rated current of the connected high-frequency tool, prevents premature or late activation in the event of brief overloading. The motor safety plug is fitted on the high-frequency power tool's connector cable instead of the normal male connector. The motor safety plug consists of a CEE plug, thermal actuators with temperature compensation and a rotary activation toggle. suited to the 852 series, setting range 6.3 - 9 A

Model	Part number
16 A	3 07 56 088 00 7
32 A	3 07 56 096 00 4



MOTOR PROTECTION PLUG
FEIN's motor safety plugs provide reliable overload protection for high-frequency power tools. A bimetallic actuator, which is individually set to the corresponding rated current of the connected high-frequency tool, prevents premature or late activation in the event of brief overloading. The motor safety plug is fitted on the high-frequency power tool's connector cable instead of the normal male connector. The motor safety plug consists of a CEE plug, thermal actuators with temperature compensation and a rotary activation toggle. suited to the 869 series, setting range 9 - 12.5 A

Model	Part number
16 A	3 07 56 089 00 1
32 A	3 07 56 097 00 8



MOTOR PROTECTION PLUG
FEIN's motor safety plugs provide reliable overload protection for high-frequency power tools. A bimetallic actuator, which is individually set to the corresponding rated current of the connected high-frequency tool, prevents premature or late activation in the event of brief overloading. The motor safety plug is fitted on the high-frequency power tool's connector cable instead of the normal male connector. The motor safety plug consists of a CEE plug, thermal actuators with temperature compensation and a rotary activation toggle. suited to the 870 series, setting range 12.5 - 16 A

Model	Part number
16 A	3 07 56 090 00 3
32 A	3 07 56 098 00 6

GENERAL ACCESSORIES FOR FREQUENCY CONVERTERS



ASSEMBLY SOCKET
over 50 V, 16 A, 100 - 300 Hz, 10 h, 3 P+E

Part number
3 07 28 141 00 8



WALL SOCKET
over 50 V, 16 A, 100 - 300 Hz, 10 h, 3 P+E

Part number
3 07 28 137 00 5

WALL SOCKET
over 50 V, 32 A, 100 - 300 Hz, 10 h, 3 P+E

Part number
3 07 28 138 00 3

DEVICE COMBINATION



DEVICE COMBINATION
for MO 83 - 7.5 KSR

Part number
3 07 49 065 00 9



DEVICE COMBINATION
for MO 83 - 11 KSR

Part number
3 07 49 073 00 6



DEVICE COMBINATION
for MO 83 - 15 KSR

Part number
3 07 49 067 00 6



DEVICE COMBINATION
for MO 83 - 20 KSR

Part number
3 07 49 068 00 4



DEVICE COMBINATION
for MO 83 - 25 KSR / MO 83 - 30 KSR

Part number
3 07 49 069 00 8



DEVICE COMBINATION
for MO 83 - 45 KSR

Part number
3 07 49 070 00 0

ACCESSORIES FOR MO 83 - 25 KSR, MO 83 - 30 KSR, MO 83 - 45 KSR

ANTI VIBRATION MOUNTS
4 items required for each frequency converter.

Part number
3 14 15 020 00 8

ACCESSORIES FOR MO 83 - 20 KSR, MO 83 - 7.5 KSR, MO 83 - 11 KSR, MO 83 - 15 KSR

ANTI VIBRATION MOUNTS
4 items required for each frequency converter.

Part number
3 14 15 081 00 1



SHEET METAL WORKING

SLITTING SHEARS **118**

Clean, distortion-free cutting of sheet metals, profiles and pipes - with just one continuous cut.

SHEET METAL SHEARS **122**

The right choice for everyone who values the highest cutting performance in sheet metal and stainless steel.

NIBBLERS **126**

Extremely versatile and curve-compatible, particularly suited for trapezoid sheet metals, corrugated sheet metals, profiles and curved single rolled sheets.



ABS 18 1.6 E SELECT	BSS 1.6 E	BSS 1.6 CE	BSS 2.0 E
Easy-to-use, curve-compatible cordless slitting shears for distortion-free cuts and cut-outs in sheet metal up to 1.6 mm.	Easy-to-use and curve-compatible slitting shears for distortion-free cutting.	Easy-to-use and curve-compatible slitting shears with integrated chip clipper.	Powerful slitting shears for stainless steel processing, spiral seam pipes and profiles.

PAGE		119	119	119	120
Cuts		++	++	++	++
Curve cuts		+	+	+	
Cut-outs		++	++	++	
QuickIN		•			
Chip clipper				•	
FEIN high-power motor			•	•	•
Input	W		350	350	350
Battery voltage	V	18			
Battery compatibility		Li-ion/ HighPower Li-ion			
Battery interface		MultiVolt*			
Strokes	rpm	2,200 - 3,500	2,100 - 4,500	2,100 - 4,500	1,300 - 2,600
Cutting speed	m/min	5 - 8	6 - 10	6 - 10	2 - 4
Steel up to 400 N/mm ²	mm	1,6	1,6	1,6	2
Steel up to 600 N/mm ²	mm	1,2	1,2	1,2	1,5
Steel up to 800 N/mm ²	mm	0,8	1	1	1,3
Non-ferrous metals up to 250 N/mm ²	mm	2	2	2	3
Cutting width	mm	5	5	5	5
Rad. of smallest curve	mm	90 (30) ¹	90 (30) ¹	90 (30) ¹	245
Immersion Ø	mm	15 (8) ¹	15 (8) ¹	15 (8) ¹	12
Cable with plug	m		5	5	5
Weight according to EPTA	kg		1,5	1,5	1,7
Weight without storage battery	kg	1,2			
Profile		+	+	+	+
Folded spiral-seam pipes		+	+	+	++
Single rolled sheets		++	++	++	++
Single rolled sheets - slightly corrugated		++	++	++	++

+ suitability ++ optimal suitability • included ¹ with blade for curves *MultiVolt interface. Cordless tool can be operated with all FEIN Li-ion batteries (12–18 V) (with the exception of 12 V / 6 Ah).

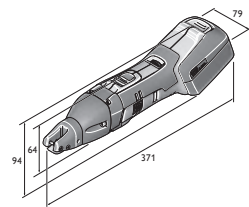

ABS 18 1.6 E

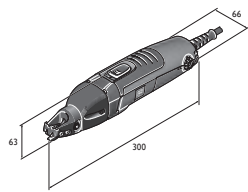

BSS 1.6 E

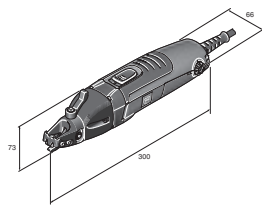

BSS 1.6 CE

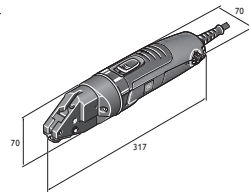

BSS 2.0 E

ABSS 18 1.6 E SELECT

Easy-to-use, curve-compatible cordless slitting shears for distortion-free cuts and cut-outs in sheet metal up to 1.6 mm.

**SUPPLIED**

1 Knife, straight, up to 1.6 mm,
1 pair of cutting bars, 1 key,
1 plastic carrying case

For accessories, see page 120

Battery voltage	V	18
Battery compatibility		Li-ion/ HighPower Li-ion
Battery interface		MultiVolt*
Strokes	rpm	2,200 - 3,500
Cutting speed	m/min	5 - 8
Steel up to 400 N/mm ²	mm	1,6
Steel up to 600 N/mm ²	mm	1,2
Steel up to 800 N/mm ²	mm	0,8
Non-ferrous metals up to 250 N/mm ²	mm	2
Cutting width	mm	5
Rad. of smallest curve	mm	90 (30) ¹
Immersion Ø	mm	15 (8) ¹
Weight without storage battery	kg	1,2

Part number	7 130 03 61 00 0
EAN	4014586886640

FEIN BENEFITS

- + Rapid work progress due to excellent view of the cutting line through the open-fronted cutting head.
- + Left and right curve cuts and distortion-free cutting possible with just one continuous chip.
- + QuickIN for rapid toolfree blade changing, with no further adjustment required.
- * MultiVolt interface. Cordless tool can be operated with all FEIN Li-ion batteries (12–18 V) (with the exception of 12 V / 6 Ah).
- + Excellent ergonomics and low weight.
- + Proven MULTIMASTER motor with outstanding performance and stability.
- + Cutting blade with excellent tool life.
- + 140 m cutting capacity (in 0.8 mm sheet metal) with one battery charge (6 Ah).
- + Clean swarf removal prevents injuries or scratches on workpieces.
- + Stainless steel up to 1.2 mm.
- + Wide range of accessories.
- ¹ with blade for curves

BSS 1.6 E

Easy-to-use and curve-compatible slitting shears for distortion-free cutting.

**SUPPLIED**

1 Knife, straight, up to 1.6 mm,
1 pair of cutting bars, 1 key

For accessories, see page 120

Input	W	350
Output	W	210
Strokes	rpm	2,100 - 4,500
Cutting speed	m/min	6 - 10
Steel up to 400 N/mm ²	mm	1,6
Steel up to 600 N/mm ²	mm	1,2
Steel up to 800 N/mm ²	mm	1
Non-ferrous metals up to 250 N/mm ²	mm	2
Cutting width	mm	5
Rad. of smallest curve	mm	90 (30) ¹
Immersion Ø	mm	15 (8) ¹
Cable with plug	m	5
Weight according to EPTA	kg	1,5

Part number	7 230 31 61 00 0
EAN	4014586874661

FEIN BENEFITS

- + Rapid work progress due to excellent view of the cutting line through the open-fronted cutting head.
- + Left and right curve cuts and distortion-free cutting possible with just one continuous chip.
- + QuickIN for rapid toolfree blade changing, with no further adjustment required.
- + Excellent ergonomics and low weight.
- + Motor with outstanding performance and stability.
- + Cutting blade with excellent tool life.
- + 5 metre cable.
- + Clean swarf removal prevents injuries or scratches on workpieces.
- + Stainless steel up to 1.2 mm.
- + Wide range of accessories.
- ¹ with blade for curves

BSS 1.6 CE

Easy-to-use and curve-compatible slitting shears with integrated chip clipper.

**SUPPLIED**

1 Knife, straight, up to 1.6 mm,
1 pair of cutting bars, 1 key

For accessories, see page 120

Input	W	350
Output	W	210
Strokes	rpm	2,100 - 4,500
Cutting speed	m/min	6 - 10
Steel up to 400 N/mm ²	mm	1,6
Steel up to 600 N/mm ²	mm	1,2
Steel up to 800 N/mm ²	mm	1
Non-ferrous metals up to 250 N/mm ²	mm	2
Cutting width	mm	5
Rad. of smallest curve	mm	90 (30) ¹
Immersion Ø	mm	15 (8) ¹
Cable with plug	m	5
Weight according to EPTA	kg	1,5

Part number	7 230 32 61 00 0
EAN	4014586874739

FEIN BENEFITS

- + Chip clipper for clipping off the cut chip at any point.
- + Left and right curve cuts and distortion-free cutting possible with just one continuous chip.
- + Rapid work progress due to excellent view of the cutting line through the open-fronted cutting head.
- + Excellent ergonomics and low weight.
- + Motor with outstanding performance and stability.
- + Cutting blade with excellent tool life.
- + 5 metre cable.
- + Clean swarf removal prevents injuries or scratches on workpieces.
- + Stainless steel up to 1.2 mm.
- + Wide range of accessories.
- ¹ with blade for curves

BSS 2.0 E

Powerful slitting shears for stainless steel processing, spiral seam pipes and profiles.

**SUPPLIED**

1 cutter blade, 1 pair of cutting bars

For accessories, see page 120

Input	W	350
Output	W	210
Strokes	rpm	1,300 - 2,600
Cutting speed	m/min	2 - 4
Steel up to 400 N/mm ²	mm	2
Steel up to 600 N/mm ²	mm	1,5
Steel up to 800 N/mm ²	mm	1,3
Non-ferrous metals up to 250 N/mm ²	mm	3
Cutting width	mm	5
Rad. of smallest curve	mm	245
Immersion Ø	mm	12
Cable with plug	m	5
Weight according to EPTA	kg	1,7

Part number	7 230 33 61 00 0
EAN	4014586874807

FEIN BENEFITS

- + High-strength blades make it ideal for reinforcement profiles in drywall construction and cutting stainless steel.
- + Robust cutting head for stationary application. Machine can be very easily clamped in a vice.
- + Left and right curve cuts and distortion-free cutting possible with just one continuous chip.
- + High performance and powerful motor when it comes to the most difficult tasks. Suitable for folded spiral-seam pipes with 4 x 0.75 mm connecting folds
- + Ideal for trimming profiled sections.
- + Best suited for trimming and cutting.
- + Motor with outstanding performance and stability.
- + Cutting blade with excellent tool life.
- + 5 metre cable.
- + Clean swarf removal prevents injuries or scratches on workpieces.
- + Stainless steel up to 1.5 mm.
- + Wide range of accessories.

GENERAL ACCESSORIES**CORDLESS ALED 12-18 V LED LAMP**

Compact and durable cordless LED lamp with swivel-mounted lamp head. Compatible with all 12 / 14 / 18 V FEIN Li-ion batteries, including hook for attaching the lamp. Extremely lightweight at 130 g and very bright at 900 Lux. Colour temperature is the equivalent of daylight. The brightness can be set to 2 levels.

Part number
9 26 04 200 02 0

**AUSB 12-18 V CORDLESS USB ADAPTER**

Compact cordless USB adapter for charging smartphones, tablets etc. without a mains connection. 2 high-speed USB charging ports for rapid charging at 2x 1.2 amps. Suitable for iOS and Android. Compatible with all 12 / 14 / 18 V FEIN Li-ion batteries.

Part number
9 26 04 201 02 0

**TOOL CASE**

Plastic, inner dimensions: 470 x 275 x 116 mm

Part number
3 39 01 118 01 0

**PLASTIC BOX**

Box insert with lockable lid for small parts and accessories, suitable for tool box 3 39 01 118 01 0, max 5 items/box.

Part number
3 39 01 119 00 0

**CUTTING PASTE**

Lubricating agents for working on sheet metals.

Part number
3 21 32 020 12 9

**QUICK CHARGER ALG 80 BC**

Bluetooth® connectivity for connecting to a mobile end device and for use with the my.FEIN app. Shows the current charge state and the number of charge cycles to date on your smartphone or tablet. Provides notification when the battery is fully charged. Short charge times thanks to high charge current of 8 amps and process-controlled charge management. Large LED display with charge indicator and USB port for mobile charging of small electrical devices. For all FEIN Li-ion batteries. Charge times (80 % of max. capacity): 12 and 18 V / 3 Ah: 31 min., 12 and 18 V / 6 Ah: 38 min., 18 V / 5.2 Ah: 33 min.

Part number
9 26 04 210 01 0

18 V BATTERY**BATTERY PACK**

Li-ion battery with charge status indicator and FEIN SafetyCell technology. Protects the battery and tool from overload, overheating and total discharge. Can be used with all FEIN 18 V cordless tools.

Current/Voltages V	Capacity Ah	Weight kg	Part number
18	6	0,7	9 26 04 175 02 0
18	3	0,45	9 26 04 182 02 0

**BATTERY STARTER SET**

2 x Li-ion batteries with ALG 80 BC rapid charger. Bluetooth® connectivity for connecting to a mobile end device and for use with the my.FEIN app. Shows the current charge state and the number of charge cycles to date on your smartphone or tablet. Provides notification when the battery is fully charged. Short charge times thanks to high charge current of 8 amps and process-controlled charge management. Large LED display with charge indicator and USB port for mobile charging of small electrical devices. For all FEIN Li-ion batteries. Charge times (80 % of max. capacity): 12 and 18 V / 3 Ah: 31 min., 12 and 18 V / 6 Ah: 38 min., 18 V / 5.2 Ah: 33 min.

Current/Voltages V	Capacity Ah	Part number
18	6	9 26 04 323 01 0
18	3	9 26 04 324 01 0

ACCESSORIES FOR (A)BSS 1.6 E, BSS 1.6 CE**CUTTING BLADE**

for steel sheet up to 400 N/mm²

Plate thickness mm	Part number
1,6	3 13 08 150 00 9

**BLADE FOR CURVES**

for steel sheet up to 400 N/mm²

Plate thickness mm	Part number
1	3 13 08 151 00 8

**CUTTING BLADE**

for stainless steel up to 800 N/mm²

Plate thickness mm	Part number
0,8	3 13 08 152 00 1

ACCESSORIES FOR (A)BSS 1.6 E**CUTTING BARS**

1 pair

Part number
3 13 08 153 01 4

ACCESSORIES FOR BSS 1.6 CE**CUTTING BARS**

1 pair

Part number
3 13 08 153 02 0

ACCESSORIES FOR BSS 2.0 E**CUTTING BLADE**

for steel sheet up to 400 N/mm²

Plate thickness mm	Part number
2	3 13 08 110 00 3

**CUTTING BLADE**

for stainless steel up to 800 N/mm²

Plate thickness mm	Part number
1,3	3 13 08 123 00 8

**CUTTING BARS**

Pack of 2

Part number
3 13 08 113 00 9

BLADE PIN

Part number
3 13 08 111 00 2



ABLS 18 1.6 E SELECT **BLS 1.6 E** **BLS 2.5 E**

Ergonomic, curve-compatible cordless sheet metal shears for cutting and trimming thin sheets. Easy-to-use, curve-compatible sheet metal shears for cutting and trimming thin sheets. Easy-to-use, curve-compatible sheet metal shears for working with stainless steel.

PAGE		123	123	123
Cuts		++	++	++
Curve cuts		+	+	+
Reversing blade			4x	4x
FEIN high-power motor			•	•
Input	W		350	350
Output	W		210	210
Battery voltage	V	18		
Battery compatibility		Li-ion/HighPower Li-ion		
Battery interface		MultiVolt*		
Strokes	rpm	2,200 - 3,700	2,300 - 4,800	800 - 1,700
Cutting speed	m/min	6 - 9	8 - 12	3 - 6
Steel up to 400 N/mm ²	mm	1,6	1,6	2,5
Steel up to 600 N/mm ²	mm	1,2	1,2	2
Steel up to 800 N/mm ²	mm	1	1	1,6
Non-ferrous metals up to 250 N/mm ²	mm	2	2	3
Rad. of smallest curve	mm	15	15	20
Cable with plug	m		5	5
Weight according to EPTA	kg		1,7	2,1
Weight without storage battery	kg	1,4		
Single rolled sheets		++	++	++
Single rolled sheets - slightly corrugated		++	++	++

+ suitability ++ optimal suitability • included *MultiVolt interface. Cordless tool can be operated with all FEIN Li-ion batteries (12–18 V) (with the exception of 12 V / 6 Ah).

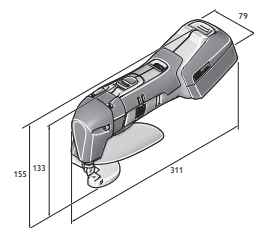

ABL 18 1.6 E

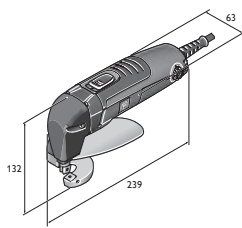

BLS 1.6 E

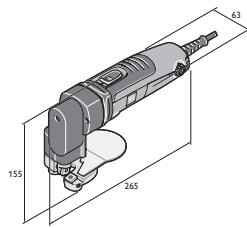

BLS 2.5 E

ABLS 18 1.6 E SELECT**SUPPLIED**

1 pair of blades, 1 set of wrenches,
1 hand guard, 1 plastic carrying case

For accessories, see page 124

Ergonomic, curve-compatible cordless sheet metal shears for cutting and trimming thin sheets.

Battery voltage	V	18
Battery compatibility		Li-ion/ HighPower Li-ion
Battery interface		MultiVolt*
Strokes	rpm	2,200 - 3,700
Cutting speed	m/min	6 - 9
Steel up to 400 N/mm ²	mm	1,6
Steel up to 600 N/mm ²	mm	1,2
Steel up to 800 N/mm ²	mm	1
Non-ferrous metals up to 250 N/mm ²	mm	2
Rad. of smallest curve	mm	15
Weight without storage battery	kg	1,4

Part number	7 130 04 61 00 0
EAN	4014586886664

FEIN BENEFITS

- + Outstanding ergonomics through compact and simple construction for optimal mobility of the shears.
- + Good curve precision with low sheet-metal distortion.
- + Four-fold reversing blade for clean and burr-free cutting with low operating costs.
- * MultiVolt interface. Cordless tool can be operated with all FEIN Li-ion batteries (12–18 V) (with the exception of 12 V / 6 Ah).
- + Perfect for trimming and cutting.
- + Unrestricted view of the cutting line.
- + Proven MULTIMASTER motor with outstanding performance and stability.
- + 160 m cutting capacity (in 0.8 mm sheet metal) with one battery charge (6 Ah).
- + Stainless steel up to 1.0 mm.

BLS 1.6 E**SUPPLIED**

1 pair of blades, 1 set of wrenches,
1 hand guard

For accessories, see page 124

Easy-to-use, curve-compatible sheet metal shears for cutting and trimming thin sheets.

Input	W	350
Output	W	210
Strokes	rpm	2,300 - 4,800
Cutting speed	m/min	8 - 12
Steel up to 400 N/mm ²	mm	1,6
Steel up to 600 N/mm ²	mm	1,2
Steel up to 800 N/mm ²	mm	1
Non-ferrous metals up to 250 N/mm ²	mm	2
Rad. of smallest curve	mm	15
Cable with plug	m	5
Weight according to EPTA	kg	1,7

Part number	7 230 34 61 00 0
EAN	4014586874876

FEIN BENEFITS

- + Outstanding ergonomics through compact and simple construction for optimal mobility of the shears.
- + Good curve precision with low sheet-metal distortion.
- + Four-fold reversing blade for clean and burr-free cutting with low operating costs.
- + Perfect for trimming and cutting.
- + Unrestricted view of the cutting line.
- + Motor with outstanding performance and stability.
- + 5 metre cable.
- + Stainless steel up to 1.0 mm.

BLS 2.5 E**SUPPLIED**

1 pair of blades, 1 set of wrenches,
1 hand guard

For accessories, see page 124

Easy-to-use, curve-compatible sheet metal shears for working with stainless steel.

Input	W	350
Output	W	210
Strokes	rpm	800 - 1,700
Cutting speed	m/min	3 - 6
Steel up to 400 N/mm ²	mm	2,5
Steel up to 600 N/mm ²	mm	2
Steel up to 800 N/mm ²	mm	1,6
Non-ferrous metals up to 250 N/mm ²	mm	3
Rad. of smallest curve	mm	20
Cable with plug	m	5
Weight according to EPTA	kg	2,1

Part number	7 230 35 61 00 0
EAN	4014586874944

FEIN BENEFITS

- + High performance and powerful motor for the most difficult tasks.
- + Unrestricted view of the cutting line makes faster work progress possible.
- + Four-fold reversing blade for clean and burr-free cutting with low operating costs.
- + Perfect for trimming and cutting.
- + Unrestricted view of the cutting line.
- + Good curve precision with low sheet-metal distortion.
- + 5 metre cable.
- + Stainless steel up to 1.6 mm.

GENERAL ACCESSORIES



CORDLESS ALED 12-18 V LED LAMP

Compact and durable cordless LED lamp with swivel-mounted lamp head. Compatible with all 12 / 14 / 18 V FEIN Li-ion batteries, including hook for attaching the lamp. Extremely lightweight at 130 g and very bright at 900 Lux. Colour temperature is the equivalent of daylight. The brightness can be set to 2 levels.

Part number
9 26 04 200 02 0



AUSB 12-18 V CORDLESS USB ADAPTER

Compact cordless USB adapter for charging smartphones, tablets etc. without a mains connection. 2 high-speed USB charging ports for rapid charging at 2x 1.2 amps. Suitable for iOS and Android. Compatible with all 12 / 14 / 18 V FEIN Li-ion batteries.

Part number
9 26 04 201 02 0



TOOL CASE

Plastic, inner dimensions: 470 x 275 x 116 mm

Part number
3 39 01 118 01 0



PLASTIC BOX

Box insert with lockable lid for small parts and accessories, suitable for tool box 3 39 01 118 01 0, max 5 items/box.

Part number
3 39 01 119 00 0



CUTTING PASTE

Lubricating agents for working on sheet metals.

Part number
3 21 32 020 12 9



QUICK CHARGER ALG 80 BC

Bluetooth® connectivity for connecting to a mobile end device and for use with the my.FEIN app. Shows the current charge state and the number of charge cycles to date on your smartphone or tablet. Provides notification when the battery is fully charged. Short charge times thanks to high charge current of 8 amps and process-controlled charge management. Large LED display with charge indicator and USB port for mobile charging of small electrical devices. For all FEIN Li-ion batteries. Charge times (80 % of max. capacity): 12 and 18 V / 3 Ah: 31 min., 12 and 18 V / 6 Ah: 38 min., 18 V / 5.2 Ah: 33 min.

Part number
9 26 04 210 01 0

18 V BATTERY



BATTERY PACK

Li-ion battery with charge status indicator and FEIN SafetyCell technology. Protects the battery and tool from overload, overheating and total discharge. Can be used with all FEIN 18 V cordless tools.

Current/Voltages V	Capacity Ah	Weight kg	Part number
18	6	0,7	9 26 04 175 02 0
18	3	0,45	9 26 04 182 02 0



BATTERY STARTER SET

2 x Li-ion batteries with ALG 80 BC rapid charger. Bluetooth® connectivity for connecting to a mobile end device and for use with the my.FEIN app. Shows the current charge state and the number of charge cycles to date on your smartphone or tablet. Provides notification when the battery is fully charged. Short charge times thanks to high charge current of 8 amps and process-controlled charge management. Large LED display with charge indicator and USB port for mobile charging of small electrical devices. For all FEIN Li-ion batteries. Charge times (80 % of max. capacity): 12 and 18 V / 3 Ah: 31 min., 12 and 18 V / 6 Ah: 38 min., 18 V / 5.2 Ah: 33 min.

Current/Voltages V	Capacity Ah	Part number
18	6	9 26 04 323 01 0
18	3	9 26 04 324 01 0

ACCESSORIES FOR (A)BLS 1.6 E



PLUNGER BLADE AND FIXED BLADE

for steel sheet up to 800 N/mm²

Part number
3 13 08 072 00 0

ACCESSORIES FOR BLS 2.5 E



PLUNGER BLADE AND FIXED BLADE

for steel sheet up to 800 N/mm²

Plate thickness mm	Part number
1,6	6 36 01 101 00 9

ACCESSORIES FOR BLS 3.5



FIXED BLADE

for steel sheet up to 400 N/mm²

Plate thickness mm	Part number
3,5	3 13 08 136 00 2



FIXED BLADE

for stainless steel up to 800 N/mm²

Plate thickness mm	Part number
2	3 13 08 143 00 6



PLUNGER BLADE
for steel sheet up to 400 N/mm²

Plate thickness mm	Part number
3,5	3 13 08 146 00 1



PLUNGER BLADE
for stainless steel up to 800 N/mm²

Plate thickness mm	Part number
2	3 13 08 147 00 5

ACCESSORIES FOR BLS 4.2



FIXED BLADE

Part number
3 13 08 092 00 8



PLUNGER BLADE
for steel sheet up to 400 N/mm²

Plate thickness mm	Part number
4,2	3 13 08 096 00 7



PLUNGER BLADE
for stainless steel up to 800 N/mm²

Plate thickness mm	Part number
2	3 13 08 098 00 9



		ABLK 18 1.3 CSE SELECT	ABLK 18 1.3 TE SELECT	ABLK 18 1.6 E SELECT	BLK 1.3 CSE
		Compact and curve-compatible nibbler for roof and façade construction. Precise cuts in corrugated sheet metal up to 1.3 mm.	Compact and curve-compatible nibbler for roof and façade construction. Precise cuts in trapezoid sheet metal up to 1.3 mm.	Compact and curve-compatible nibbler for roof and façade construction. Precise cuts in trapezoid and corrugated sheet metals and profiles.	Compact and rapid nibbler for corrugated sheet metals.
PAGE		128	128	129	129
Curve cuts		++	++	++	++
Cut-outs		+	+	++	+
QuickIN		•	•	•	•
Cutting direction		8 x 45°	8 x 45°	8 x 45°	8 x 45°
Rotating round punch		•	•	•	•
Input	W				350
Output	W				210
Battery voltage	V	18	18	18	
Battery compatibility		Li-ion/ HighPower Li-ion	Li-ion/ HighPower Li-ion	Li-ion/ HighPower Li-ion	
Battery interface		MultiVolt*	MultiVolt*	MultiVolt*	
Strokes	rpm	900 - 1,600	900 - 1,600	800 - 1,300	1,000 - 1,800
Cutting speed	m/min	1,9	1,9	1,5	2,3
Steel up to 400 N/mm ²	mm	1,3	1,3	1,6	1,3
Steel up to 600 N/mm ²	mm	0,8	0,8	1	0,8
Steel up to 800 N/mm ²	mm	0,6	0,6	0,7	0,6
Non-ferrous metals up to 250 N/mm ²	mm	2	2	2,5	2
Cutting width	mm	4	4	5	4
Immersion Ø with die	mm	19	19	22	19
Rad. of smallest curve (inside/outside)	mm	15 / 20	25 / 30	30 / 35	15 / 20
Cable with plug	m				5
Weight according to EPTA	kg				1,8
Weight without storage battery	kg	1,6	1,6	1,65	
Trapezoid sheet metal up to 85 mm deep channels		+	++	++	+
Corrugated sheet metal		++	+	++	++
Profile					
Single rolled sheets		++	++	++	++
Single rolled sheets - slightly corrugated		++	++	++	++
Trapezoid sheet metal up to 160 mm deep channels		+	++	++	+

+ suitability ++ optimal suitability • included

*MultiVolt interface. Cordless tool can be operated with all FEIN Li-ion batteries (12–18 V) (with the exception of 12 V / 6 Ah).



ABLK 18 1.3 CSE
ABLK 18 1.3 TE



ABLK 18 1.6 E

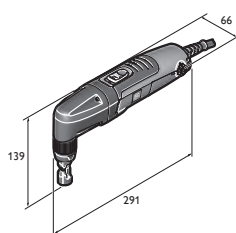

BLK 1.3 CSE

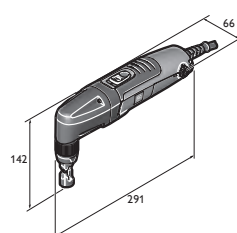

BLK 1.3 TE

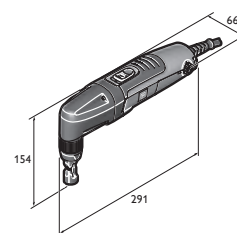

BLK 1.6 E



BLK 1.3 TE	BLK 1.6 E	BLK 1.6 LE	BLK 2.0 E	BLK 3.5	BLK 5.0
Compact and rapid nibbler for trapezoid sheet metals.	Universal nibbler for sheets, profiles, trapezoid and corrugated sheet metals.	Compact nibbler for deep-channel trapezoidal sheet metals in roof and façade construction.	Compact nibbler with unlimited curve precision for corners and edges.	Powerful nibbler with unlimited curve-compatibility for grooves and cut-outs.	Powerful nibbler for heavy dismantling and cutting applications.
130	130	131	131	132	132
++	+	++	++	++	+
+	++	+	++	+	
•	•	•	•	•	
8 x 45°	8 x 45°	8 x 45°	8 x 45°	3 x 90°	3 x 90°
•	•	•	•	•	
350	350	350	350	1 200	1 200
210	210	210	210	750	750

1,000 - 1,800	800 - 1,500	800 - 1,500	500 - 1,000	750	750
2,3	1,9	2,7	1	1,3	1,3
1,3	1,6	1,6	2	3,5	5
0,8	1	1	1,5	2,3	3,3
0,6	0,7	0,7	1	1,8	2,5
2	2,5	2,5	2,5	3,5	7
4	5	5	8	14	8
19	22	24	18	30	43
25 / 30	30 / 35	65 / 70	4 / 0	7 / 0	86 / 94
5	5	5	5	5	5
1,8	1,8	1,9	1,8	3,5	3,8
++	++	++			
+	++	++	+	+	+
		+			+
++	++	++	++	++	++
++	++	++	++	++	++
++	++				

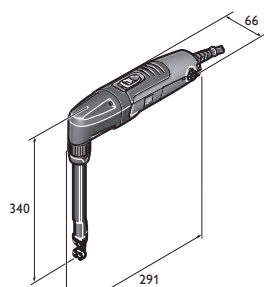

BLK 1.6 LE

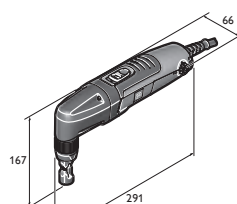

BLK 2.0 E

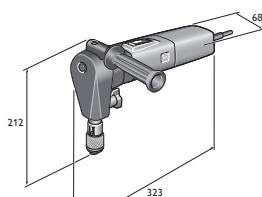

BLK 3.5

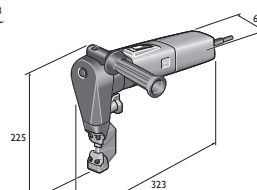

BLK 5.0

ABLK 18 1.3 CSE SELECT Compact and curve-compatible nibbler for roof and façade construction. Precise cuts in corrugated sheet metal up to 1.3 mm.**SUPPLIED**

1 die for corrugated sheet metal (3 01 09 169 00 9),
1 punch (6 36 02 050 00 0),
1 plastic carrying case

For accessories, see page 133

Battery voltage	V	18
Battery compatibility		Li-ion/ HighPower Li-ion
Battery interface		MultiVolt*
Strokes	rpm	900 - 1,600
Cutting speed	m/min	1,9
Steel up to 400 N/mm ²	mm	1,3
Steel up to 600 N/mm ²	mm	0,8
Steel up to 800 N/mm ²	mm	0,6
Non-ferrous metals up to 250 N/mm ²	mm	2
Cutting width	mm	4
Immersion Ø with die	mm	19
Rad. of smallest curve (inside/outside)	mm	15 / 20
Weight without storage battery	kg	1,6

FEIN BENEFITS

- + 45 m cutting capacity (in 0.8 mm sheet metal) with one battery charge (6 Ah).
- + 1.9 m/min cutting speed for excellent work progress.
- + Variable cutting speed due to electronically adjustable speed control.
- * MultiVolt interface. Cordless tool can be operated with all FEIN Li-ion batteries (12–18 V) (with the exception of 12 V / 6 Ah).
- + Brief overlapping area up to 2.6 mm.
- + Optimum handling due to extremely slim gearbox head.
- + Comfortably light weight.
- + QuickIN quick change system for die and punch.
- + Rotating punch for a service life which is now up to 30 % longer.
- + Cutting direction setting can be changed in 45° steps up to 360° using tool-free pivoting cutting head.
- + Proven MULTIMASTER motor with outstanding performance and stability.

Part number	7 132 05 61 00 0
EAN	4014586886701

ABLK 18 1.3 TE SELECT Compact and curve-compatible nibbler for roof and façade construction. Precise cuts in trapezoid sheet metal up to 1.3 mm.**SUPPLIED**

1 die for trapezoidal sheet metal (3 01 09 170 00 1),
1 punch (6 36 02 050 00 0),
1 plastic carrying case

For accessories, see page 133

Battery voltage	V	18
Battery compatibility		Li-ion/ HighPower Li-ion
Battery interface		MultiVolt*
Strokes	rpm	900 - 1,600
Cutting speed	m/min	1,9
Steel up to 400 N/mm ²	mm	1,3
Steel up to 600 N/mm ²	mm	0,8
Steel up to 800 N/mm ²	mm	0,6
Non-ferrous metals up to 250 N/mm ²	mm	2
Cutting width	mm	4
Immersion Ø with die	mm	19
Rad. of smallest curve (inside/outside)	mm	25 / 30
Weight without storage battery	kg	1,6

FEIN BENEFITS

- + 45 m cutting capacity (in 0.8 mm sheet metal) with one battery charge (6 Ah).
- + 1.9 m/min cutting speed for excellent work progress.
- + Variable cutting speed due to electronically adjustable speed control.
- * MultiVolt interface. Cordless tool can be operated with all FEIN Li-ion batteries (12–18 V) (with the exception of 12 V / 6 Ah).
- + Brief overlapping area up to 2.6 mm.
- + Optimum handling due to extremely slim gearbox head.
- + Comfortably light weight.
- + QuickIN quick change system for die and punch.
- + Rotating punch for a service life which is now up to 30 % longer.
- + Cutting direction setting can be changed in 45° steps up to 360° using tool-free pivoting cutting head.
- + Proven MULTIMASTER motor with outstanding performance and stability.

Part number	7 132 06 61 00 0
EAN	4014586886725

ABLK 18 1.6 E SELECT

Compact and curve-compatible nibbler for roof and façade construction. Precise cuts in trapezoid and corrugated sheet metals and profiles.

**SUPPLIED**

1 die (3 01 09 141 00 3),
1 punch (6 36 02 048 00 4),
1 plastic carrying case

For accessories, see page 133

Battery voltage	V	18
Battery compatibility		Li-ion/ HighPower Li-ion
Battery interface		MultiVolt*
Strokes	rpm	800 - 1,300
Cutting speed	m/min	1,5
Steel up to 400 N/mm ²	mm	1,6
Steel up to 600 N/mm ²	mm	1
Steel up to 800 N/mm ²	mm	0,7
Non-ferrous metals up to 250 N/mm ²	mm	2,5
Cutting width	mm	5
Immersion Ø with die	mm	22
Rad. of smallest curve (inside/ outside)	mm	30 / 35
Weight without storage battery	kg	1,65

Part number	7 132 04 61 00 0
EAN	4014586886688

FEIN BENEFITS

- + 45 m cutting capacity (in 0.8 mm sheet metal) with one battery charge (6 Ah).
- + 1.5 m/min cutting speed for excellent work progress.
- + Variable cutting speed due to electronically adjustable speed control.
- * MultiVolt interface. Cordless tool can be operated with all FEIN Li-ion batteries (12–18 V) (with the exception of 12 V / 6 Ah).
- + Brief overlapping area up to 2.6 mm.
- + Optimum handling due to extremely slim gearbox head.
- + Comfortably light weight.
- + QuickIN quick change system for die and punch.
- + Rotating punch for a service life which is now up to 30 % longer.
- + Cutting direction setting can be changed in 45° steps up to 360° using tool-free pivoting cutting head.
- + Proven MULTIMASTER motor with outstanding performance and stability.
- + Low operating costs. Punch and die are replaced independently of one another.

BLK 1.3 CSE

Compact and rapid nibbler for corrugated sheet metals.

**SUPPLIED**

1 die for corrugated sheet
metal (3 01 09 169 00 9),
1 punch (6 36 02 050 00 0)

For accessories, see page 133

Input	W	350
Output	W	210
Strokes	rpm	1,000 - 1,800
Cutting speed	m/min	2,3
Steel up to 400 N/mm ²	mm	1,3
Steel up to 600 N/mm ²	mm	0,8
Steel up to 800 N/mm ²	mm	0,6
Non-ferrous metals up to 250 N/mm ²	mm	2
Cutting width	mm	4
Immersion Ø with die	mm	19
Rad. of smallest curve (inside/ outside)	mm	15 / 20
Cable with plug	m	5
Weight according to EPTA	kg	1,8

Part number	7 232 42 60 00 0
EAN	4014586870137

FEIN BENEFITS

- + Cutting direction setting can be changed in 45° steps up to 360° using tool-free pivoting cutting head.
- + 2.3 m/min cutting speed for excellent work progress.
- + Optimum ergonomics with a handle up to 20 % slimmer because of its extremely thin drive head.
- + Chip protection mesh on vent slots.
- + Low operating costs due to long tool life of punch and die.
- + Rotating punch for a service life which is now up to 30 % longer.
- + QuickIN clamping system.
- + Stainless steel up to 0.6 mm.
- + Motor with outstanding performance and stability.
- + 5 metre cable.

BLK 1.3 TE**SUPPLIED**

1 die for trapezoidal sheet metal (3 01 09 170 00 1),
1 punch (6 36 02 050 00 0)

For accessories, see page 133

Compact and rapid nibbler for trapezoid sheet metals.

Input	W	350
Output	W	210
Strokes	rpm	1,000 - 1,800
Cutting speed	m/min	2,3
Steel up to 400 N/mm ²	mm	1,3
Steel up to 600 N/mm ²	mm	0,8
Steel up to 800 N/mm ²	mm	0,6
Non-ferrous metals up to 250 N/mm ²	mm	2
Cutting width	mm	4
Immersion Ø with die	mm	19
Rad. of smallest curve (inside/outside)	mm	25 / 30
Cable with plug	m	5
Weight according to EPTA	kg	1,8

Part number	7 232 41 60 00 0
EAN	4014586870069

FEIN BENEFITS

- + Cutting direction setting can be changed in 45° steps up to 360° using tool-free pivoting cutting head.
- + 2.3 m/min cutting speed for excellent work progress.
- + Optimum ergonomics with a handle up to 20 % slimmer because of its extremely thin drive head.
- + Chip protection mesh on vent slots.
- + Low operating costs due to long tool life of punch and die.
- + Brief overlapping area up to 2.6 mm.
- + Rotating punch for a service life which is now up to 30 % longer.
- + QuickIN clamping system.
- + Stainless steel up to 0.6 mm.
- + Motor with outstanding performance and stability.
- + 5 metre cable.

BLK 1.6 E**SUPPLIED**

1 die (3 01 09 141 00 3),
1 punch (6 36 02 048 00 4)

For accessories, see page 133

Universal nibbler for sheets, profiles, trapezoid and corrugated sheet metals.

Input	W	350
Output	W	210
Strokes	rpm	800 - 1,500
Cutting speed	m/min	1,9
Steel up to 400 N/mm ²	mm	1,6
Steel up to 600 N/mm ²	mm	1
Steel up to 800 N/mm ²	mm	0,7
Non-ferrous metals up to 250 N/mm ²	mm	2,5
Cutting width	mm	5
Immersion Ø with die	mm	22
Rad. of smallest curve (inside/outside)	mm	30 / 35
Cable with plug	m	5
Weight according to EPTA	kg	1,8

Part number	7 232 38 60 00 0
EAN	4014586869858

FEIN BENEFITS

- + Almost indestructible. Ideal for flexible and universal use with sheet thickness up to 1.6 mm..
- + Optimum ergonomics with a handle up to 20 % slimmer because of its extremely thin drive head.
- + Cutting direction setting can be changed in 45° steps up to 360° using tool-free pivoting cutting head.
- + QuickIN clamping system.
- + High cutting speed.
- + Rotating punch for a service life which is now up to 30 % longer.
- + Low operating costs due to long tool life of punch and die.
- + Motor with outstanding performance and stability.
- + Chip protection mesh on vent slots.
- + 5 metre cable.
- + Stainless steel up to 0.7 mm.
- + Retrofittable trapezoid profile set up to 160 mm deep channels.

BLK 1.6 LE

Compact nibbler for deep-channel trapezoidal sheet metals in roof and façade construction.

Input	W	350
Output	W	210
Strokes	rpm	800 - 1,500
Cutting speed	m/min	2,7
Steel up to 400 N/mm ²	mm	1,6
Steel up to 600 N/mm ²	mm	1
Steel up to 800 N/mm ²	mm	0,7
Non-ferrous metals up to 250 N/mm ²	mm	2,5
Cutting width	mm	5
Immersion Ø with die	mm	24
Rad. of smallest curve (inside/outside)	mm	65 / 70
Cable with plug	m	5
Weight according to EPTA	kg	1,9

FEIN BENEFITS

- + The specialist when it comes to zero compromise work on trapezoidal sheet metals with deep channels of up to 160 mm.
- + Optimum ergonomics with a handle up to 20 % slimmer because of its extremely thin drive head.
- + Cutting direction setting can be changed in 45° steps up to 360° using tool-free pivoting cutting head.
- + QuickIN clamping system.
- + High cutting speed.
- + Motor with outstanding performance and stability.
- + Chip protection mesh on vent slots.
- + 5 metre cable.
- + Stainless steel up to 0.7 mm.

SUPPLIED

1 die for trapezoidal sheet metal (3 13 09 122 00 5),
1 punch (6 36 02 049 00 8),
1 wearing plate

For accessories, see page 133

Part number	7 232 39 60 00 0
EAN	4014586869926

BLK 2.0 E

Compact nibbler with unlimited curve precision for corners and edges.

Input	W	350
Output	W	210
Strokes	rpm	500 - 1,000
Cutting speed	m/min	1
Steel up to 400 N/mm ²	mm	2
Steel up to 600 N/mm ²	mm	1,5
Steel up to 800 N/mm ²	mm	1
Non-ferrous metals up to 250 N/mm ²	mm	2,5
Cutting width	mm	8
Immersion Ø with die	mm	18
Rad. of smallest curve (inside/outside)	mm	4 / 0
Cable with plug	m	5
Weight according to EPTA	kg	1,8

FEIN BENEFITS

- + High curve precision due to special cutting head geometry. Nibbler can turn on the spot.
- + Especially well-suited for cutting edged sheet metals with a minimum bend radius of 3 mm.
- + Cutting direction setting can be changed in 45° steps up to 360° using tool-free pivoting cutting head.
- + QuickIN clamping system.
- + Optimal ergonomics.
- + Motor with outstanding performance and stability.
- + Ideal for cut-outs.
- + Optimally suited for template cuts.
- + Chip protection mesh on vent slots.
- + 5 metre cable.
- + Stainless steel up to 1.0 mm.

SUPPLIED

1 die (3 13 09 040 00 2),
1 punch (6 36 02 051 00 9)

For accessories, see page 133

Part number	7 232 40 60 00 0
EAN	4014586869995

BLK 3.5

Powerful nibbler with unlimited curve-compatibility for grooves and cut-outs.

**SUPPLIED**

1 die (3 13 09 093 00 3),
1 punch (3 13 09 097 00 2),
1 additional handle

For accessories, see page 133

Input	W	1 200
Output	W	750
Strokes	rpm	750
Cutting speed	m/min	1,3
Steel up to 400 N/mm ²	mm	3,5
Steel up to 600 N/mm ²	mm	2,3
Steel up to 800 N/mm ²	mm	1,8
Non-ferrous metals up to 250 N/mm ²	mm	3,5
Cutting width	mm	14
Immersion Ø with die	mm	30
Rad. of smallest curve (inside/outside)	mm	7 / 0
Cable with plug	m	5
Weight according to EPTA	kg	3,5

FEIN BENEFITS

- + Ideally suited for grooves and cut-outs in sheet metals, tool can turn on the spot.
- + Cutting direction can be adjusted in 90° steps without the need for tools.
- + QuickIN clamping system for quick, tool-free punch and die changes.
- + Optimum power-to-weight ratio.
- + Long tool life, punches can be reground.
- + Motor with outstanding performance and stability.
- + Warp-free cutting of flat and bent sheet metal.
- + Optimally suited for template cuts.
- + Chip protection mesh on vent slots.
- + Handle can be rotated 180°.
- + 5 metre cable.
- + Stainless steel up to 1.8 mm.
- + Wide range of accessories.

Part number	7 232 30 00 23 0
EAN	4014586848655

BLK 5.0

Powerful nibbler for heavy dismantling and cutting applications.

**SUPPLIED**

1 die (3 13 09 107 00 0),
1 punch (3 13 09 110 00 4),
1 additional handle

For accessories, see page 133

Input	W	1 200
Output	W	750
Strokes	rpm	750
Cutting speed	m/min	1,3
Steel up to 400 N/mm ²	mm	5
Steel up to 600 N/mm ²	mm	3,3
Steel up to 800 N/mm ²	mm	2,5
Non-ferrous metals up to 250 N/mm ²	mm	7
Cutting width	mm	8
Immersion Ø with die	mm	43
Rad. of smallest curve (inside/outside)	mm	86 / 94
Cable with plug	m	5
Weight according to EPTA	kg	3,8

FEIN BENEFITS

- + Powerful 1 200 W motor for outstanding performance while maintaining excellent ergonomics.
- + Cuts over 90° edges, for example on guard rails or tanks.
- + Cutting direction can be adjusted in 90° steps without the need for tools.
- + Optimum power-to-weight ratio.
- + Long tool life of punch and die.
- + Chip protection mesh on vent slots.
- + Handle can be rotated 180°.
- + 5 metre cable.
- + Stainless steel up to 2.5 mm.
- + Wide range of accessories.

Part number	7 232 31 00 23 9
EAN	4014586848662

GENERAL ACCESSORIES



CORDLESS ALED 12-18 V LED LAMP

Compact and durable cordless LED lamp with swivel-mounted lamp head. Compatible with all 12 / 14 / 18 V FEIN Li-ion batteries, including hook for attaching the lamp. Extremely lightweight at 130 g and very bright at 900 Lux. Colour temperature is the equivalent of daylight. The brightness can be set to 2 levels.

Part number

9 26 04 200 02 0



AUSB 12-18 V CORDLESS USB ADAPTER

Compact cordless USB adapter for charging smartphones, tablets etc. without a mains connection. 2 high-speed USB charging ports for rapid charging at 2x 1.2 amps. Suitable for iOS and Android. Compatible with all 12 / 14 / 18 V FEIN Li-ion batteries.

Part number

9 26 04 201 02 0



TOOL CASE

Plastic, inner dimensions: 470 x 275 x 116 mm

Part number

3 39 01 118 01 0



PLASTIC BOX

Box insert with lockable lid for small parts and accessories, suitable for tool box 3 39 01 118 01 0, max 5 items/box.

Part number

3 39 01 119 00 0



CUTTING PASTE

Lubricating agents for working on sheet metals.

Part number

3 21 32 020 12 9



QUICK CHARGER ALG 80 BC

Bluetooth® connectivity for connecting to a mobile end device and for use with the my.FEIN app. Shows the current charge state and the number of charge cycles to date on your smartphone or tablet. Provides notification when the battery is fully charged. Short charge times thanks to high charge current of 8 amps and process-controlled charge management. Large LED display with charge indicator and USB port for mobile charging of small electrical devices. For all FEIN Li-ion batteries. Charge times (80 % of max. capacity): 12 and 18 V / 3 Ah: 31 min., 12 and 18 V / 6 Ah: 38 min., 18 V / 5.2 Ah: 33 min.

Part number

9 26 04 210 01 0

18 V BATTERY



BATTERY PACK

Li-ion battery with charge status indicator and FEIN SafetyCell technology. Protects the battery and tool from overload, overheating and total discharge. Can be used with all FEIN 18 V cordless tools.

Current/Voltages V	Capacity Ah	Weight kg	Part number
18	6	0,7	9 26 04 175 02 0
18	3	0,45	9 26 04 182 02 0



BATTERY STARTER SET

2 x Li-ion batteries with ALG 80 BC rapid charger. Bluetooth® connectivity for connecting to a mobile end device and for use with the my.FEIN app. Shows the current charge state and the number of charge cycles to date on your smartphone or tablet. Provides notification when the battery is fully charged. Short charge times thanks to high charge current of 8 amps and process-controlled charge management. Large LED display with charge indicator and USB port for mobile charging of small electrical devices. For all FEIN Li-ion batteries. Charge times (80 % of max. capacity): 12 and 18 V / 3 Ah: 31 min., 12 and 18 V / 6 Ah: 38 min., 18 V / 5.2 Ah: 33 min.

Current/Voltages V	Capacity Ah	Part number
18	6	9 26 04 323 01 0
18	3	9 26 04 324 01 0

ACCESSORIES FOR (A)BLK 1.3 CSE



PUNCH

for steel sheet up to 400 N/mm²

Plate thickness mm	No. in pack pcs	Part number
1,3	1	6 36 02 050 00 0
1,3	5	6 36 02 050 03 0
1,3	10	6 36 02 050 01 0

DIE

for corrugated sheet metal

No. in pack pcs	Part number
1	3 01 09 169 00 9
2	3 01 09 169 04 0

PUNCHES AND DIES IN A SET

consisting of 5 x punches 6 36 02 050 00 0 and 1 x die 3 01 09 169 00 9.

Part number

3 01 09 169 03 0

ACCESSORIES FOR (A)BLK 1.3 TE

PUNCHES AND DIES IN A SET

consisting of 5 x punches 6 36 02 050 00 0 and 1 x die 3 01 09 170 00 1.

Part number

3 01 09 170 03 0

DIE

for trapezoidal sheet metal

No. in pack pcs	Part number
1	3 01 09 170 00 1
2	3 01 09 170 04 0

ACCESSORIES FOR (A)BLK 1.6 E



PUNCH

No. in pack pcs	Part number
1	6 36 02 048 00 4
5	6 36 02 048 04 0
10	6 36 02 048 05 0



DIE

No. in pack pcs	Part number
1	3 01 09 141 00 3
2	3 01 09 141 02 0
5	3 01 09 141 03 0



PUNCHES AND DIES

In set, each consisting of 1x punch 6 36 02 048 00 4 and 1x die 3 01 09 141 00 3.

Part number
6 36 02 048 01 3



DIE HOLDER

for trapezoidal sheet metal and corrugated sheet metal

Part number
3 01 09 154 00 7



PROFILE SET 160

For deep-channel trapezoidal sheet metals (85-160 mm), incl. 1 punch, die and wearing plate.

Part number
9 26 02 071 01 9

ACCESSORIES FOR BLK 1.6 LE

PUNCHES AND DIES

In the set, for profile set 160, including wear plate, screws and key. Profile set 160

Part number
6 36 02 049 01 7



PUNCH

No. in pack pcs	Part number
1	6 36 02 049 00 8
2	6 36 02 049 04 0
5	6 36 02 049 05 0

DIE

No. in pack pcs	Part number
1	3 13 09 122 00 5
2	3 13 09 122 02 0
5	3 13 09 122 03 0

WEARING PLATE

Profile set 160

Part number
3 13 09 121 00 2

ACCESSORIES FOR BLK 2.0 E

DIE

RSS 636

Part number
3 13 09 040 00 2



PUNCH

Part number
6 36 02 051 01 9



PUNCHES AND DIES IN A SET

Consisting of: 1 die 6 36 02 051 00 9 and 1 punch 3 13 09 040 00 2

Part number
6 36 02 051 01 8

ACCESSORIES FOR BLK 3.5



PUNCH

for steel sheet up to 400 N/mm²

Part number
3 13 09 097 00 2



PUNCH

for stainless steel up to 800 N/mm²

Part number
3 13 09 098 00 0



DIE

for steel sheet up to 400 N/mm²

Part number
3 13 09 093 00 3



DIE

for stainless steel up to 800 N/mm²

Part number
3 13 09 094 00 1

ACCESSORIES FOR BLK 5.0**PUNCHES AND DIES IN A SET**

Up to 5.0 mm steel plate (400 N/mm²), consisting of:
1 punch 3 13 09 110 00 4 and 1 die 3 13 09 107 00 0.

Part number

3 13 09 110 01 3

PUNCHES AND DIES IN A SET

Up to 3.0 mm stainless steel plate (600 N/mm²), consisting of:
1 punch 3 13 09 134 00 6 and 1 die 3 13 09 108 00 8.

Part number

3 13 09 134 01 5

**CHIPS BAG**

Part number

3 13 09 114 00 8

PUNCH

Up to 7.0 mm aluminium steel plate (250 N/mm²)
up to 5.0 mm steel sheet (400 N/mm²).

Part number

3 13 09 110 00 4

PUNCH

Up to 3.0 mm stainless steel plate (600 N/mm²).

Part number

3 13 09 134 00 6

DIE

for steel sheet up to 5 mm thickness

Part number

3 13 09 107 00 0

DIE

Up to 3.0 mm stainless steel plate (600 N/mm²).

Part number

3 13 09 108 00 8

DIE

Up to 7.0 mm aluminium steel plate (250 N/mm²)
up to 5.0 mm steel sheet (400 N/mm²).

Part number

3 13 09 109 00 2



SAWING AND CUTTING

JIGSAWS **138**

Optimum cutting speed with minimal wear.

PIPE SAWS **141**

Optimum cutting speed with minimal wear.

CHOP SAWS **145**

Saw safely with speed and precision with the chop saw for metal.

BEVELLER **146**

For efficiently producing exposed and functional edges as well as rounding edges.

PIPE MILLING MACHINE **152**

Cost-effective pipe machining with high cutting performance.



AST 638

Metal jigsaws with unsurpassed precision, robustness and service life.

ASTE 638

Metal jigsaws with continuously variable speed control and stainless steel base plate for unsurpassed precision, robustness and service life.

PAGE		139	139
Adjustable stroke			•
Stainless steel foot plate		•	•
Swarf removal can be switched over		•	•
Input	W	350	450
Strokes	rpm	3,350	1,050 - 2,600
Stroke of blade	mm	20	20
Stainless steel (V2A)	mm	3	6
Steel (St 37)	mm	8	10
alu, copper, brass	mm	10 / 10	15 / 10
Hard/soft wood and plywood	mm	50 / 40	60 / 50
Hard particle / fibre-glass materials	mm	25 / 20	30 / 30
steel/woods and plastics	mm	8 / 6	8 / 6
Cable with plug	m	5	5
Weight according to EPTA	kg	2,2	2,3
Stainless steel		+	++
Steel		++	++
wood		+	++
Fabric-based laminate / composite materials		+	++

+ suitability ++ optimal suitability • included

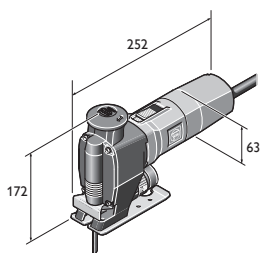

ASt 638
ASte 638

AST 638**SUPPLIED**

2 packs of saw blades,
1 anti-chipping protector

For accessories, see page 140

Metal jigsaws with unsurpassed precision, robustness and service life.

Input	W	350
Output	W	200
Strokes	rpm	3,350
Stroke of blade	mm	20
Stainless steel (V2A)	mm	3
Steel (St 37)	mm	8
alu, copper, brass	mm	10 / 10
Hard/soft wood and plywood	mm	50 / 40
Hard particle / fibre-glass materials	mm	25 / 20
steel/woods and plastics	mm	8 / 6
Cable with plug	m	5
Weight according to EPTA	kg	2,2

Part number	7 234 17 00 23 9
EAN	4014586841670

FEIN BENEFITS

- + Extremely low levels of wear and maintenance even when used in very demanding industrial applications.
- + Machine concept for optimum results in metals, insulation materials (sandwich) and hard wood.
- + Excellent ergonomics.
- + Outstanding smooth running thanks to precisely balanced weight distribution.
- + Swarf removal can be switched between extraction or blowing.

ASTE 638**SUPPLIED**

2 packs of saw blades,
1 anti-chipping protector,
1 Chip protection additional

For accessories, see page 140

Metal jigsaws with continuously variable speed control and stainless steel base plate for unsurpassed precision, robustness and service life.







Input	W	450
Output	W	245
Strokes	rpm	1,050 - 2,600
Stroke of blade	mm	20
Stainless steel (V2A)	mm	6
Steel (St 37)	mm	10
alu, copper, brass	mm	15 / 10
Hard/soft wood and plywood	mm	60 / 50
Hard particle / fibre-glass materials	mm	30 / 30
steel/woods and plastics	mm	8 / 6
Cable with plug	m	5
Weight according to EPTA	kg	2,3

Part number	7 234 15 00 23 0
EAN	4014586839332





FEIN BENEFITS

- + Tool concept for optimum results in metals, stainless steel, insulation material (sandwich) and hardwood. With extremely robust 4 mm thick stainless steel base plate.
- + Continuously variable, electronic speed setting for optimum cutting speed and saw blade service life
- + Excellent ergonomics.
- + Outstanding smooth running thanks to precisely balanced weight distribution.
- + Swarf removal can be switched between extraction or blowing.

SAW BLADES FOR METAL AND SANDWICH MATERIAL

	METAL	ALU	Cu Fe Ni Mn Zn	STAINLESS STEEL INOX NIBOSTA	PVC	SANDWICH			Qualität/ Quality	No. in pack Qty.	Part number
	< 1,2	< 1,2					77	0,7	HSS	5	6 35 03 060 01 0
	< 1,2						100	0,7	HSS	5	6 35 03 076 01 0
	< 2,0	< 2,0	< 2,0	< 4,0	< 70,0	120	1,2	HSS	5	6 35 03 077 01 4	
	< 10,0	< 8,0	< 10,0	< 30,0	< 120	180	2	BIM	5	6 35 03 114 01 0	
	< 2,0	< 2,0	< 2,0	< 2,0	< 4,0		88	1,2	BIM	5	6 35 03 112 01 0
	< 10,0	< 8,0	< 10,0	< 6,0	< 8,0		88	2,0	BIM	5	6 35 03 113 01 0
	< 6,0	< 15,0					100	3,0	BIM	5	6 35 03 088 01 1

SAW BLADES FOR WOOD AND OTHER MATERIALS

	FIBREGLASS		PVC				Qualität/ Quality	No. in pack Qty.	Part number
	< 40,0	< 15,0	< 25,0	88	3,0	HCS	5	6 35 03 037 01 8	
	< 50,0	< 30,0	< 50,0	88	4,0	HCS	5	6 35 03 038 01 6	
	< 60,0	< 30,0	< 60,0	100	4,0	HCS	5	6 35 03 082 01 0	
	< 25,0	< 30,0		88	4,0	HSS	5	6 35 03 039 01 0	
	< 10,0			77		50 Diamond	1	6 35 03 061 01 9	

GENERAL ACCESSORIES

TOOL CASE
Plastic, inner dimensions: 470 x 275 x 116 mm



Part number
3 39 01 118 01 0

PLASTIC BOX
Box insert with lockable lid for small parts and accessories, suitable for tool box 3 39 01 118 01 0, max 5 items/box.



Part number
3 39 01 119 00 0

CUTTING PASTE
Lubricating agents for working on sheet metals.



Part number
3 21 32 020 12 9

ANTI-CHIPPING PROTECTOR
Pack of 5



No. in pack
pcs

Part number
3 14 28 102 01 6

CHIPPING PROTECTOR
for ASt(e) 638



Part number
3 27 14 088 00 7

HOSE SLEEVE
For the connection of FEIN Electric Power Tools with dust extraction.



Ø
mm

Part number

32 3 05 17 028 00 7

27 3 05 17 029 00 1

CONNECTING PIECE
Universal device to connect power tools and accessories with dust extraction to vacuum cleaner. Flexible rubber sleeve, length 70 mm, inner diameter 31.5 mm.



Part number
3 13 22 771 00 9

STS 325 R**SUPPLIED**

2 saw blades, 1 set of keys,
1 additional handle, 1 hose coupling

For accessories, see page 143

Compressed air hacksaw for pipes and profiled sections.

Operating pressure	bar	6
Air consumption	m ³ /min	1,5
Output	W	1 100
Strokes	rpm	330
Stroke of blade	mm	60
Pipes up to Ø	mm	440 *
profiles up to W x H	mm	290 x 500
Weight according to EPTA	kg	7,2

Part number	7 534 08 00 00 0
EAN	4014586855639

FEIN BENEFITS

- + Ideally suited for trimming pipes and shaped section made of steel, cast-iron, autoclaved aerated concrete and plastics.
- + Clamp and feed device available for profiles and pipes from Ø 80 mm to Ø 400 mm.
- + Adjustable clamping devices permit mitre cuts up to 45° as well.
- + Clamp and feed device.
- + Adjustable clamping fixtures.
- * With chain extension.

ASTX 649-1**SUPPLIED**

2 saw blades, 1 additional handle,
1 set of keys

For accessories, see page 143

Powerful hacksaw for pipes and profiled sections.

Input	W	750
Output	W	480
Strokes	rpm	350
Stroke of blade	mm	60
Pipes up to Ø	mm	440 *
profiles up to W x H	mm	290 x 550
Cable with plug	m	2,5
Weight according to EPTA	kg	6,1

Part number	7 234 22 00 23 0
EAN	4014586858470

FEIN BENEFITS

- + Ideally suited for trimming pipes and shaped section made of steel, cast-iron, autoclaved aerated concrete and plastics.
- + Clamp and feed device available for profiles and pipes from Ø 80 mm to Ø 400 mm.
- + Especially suitable for sandwich material and layers of different materials.
- + Adjustable clamping devices permit mitre cuts up to 45° as well.
- * With chain extension.

ASTXE 649-1**SUPPLIED**

2 saw blades, 1 additional handle,
1 set of keys

For accessories, see page 143

Powerful hacksaw for pipes and profiled sections with continuously variable speed adjustment.













Input	W	750
Output	W	480
Strokes	rpm	100 - 350
Stroke of blade	mm	60
Pipes up to Ø	mm	400 *
profiles up to W x H	mm	290 x 550
Cable with plug	m	2,5
Weight according to EPTA	kg	6,4

Part number	7 234 23 00 23 0
EAN	4014586858500

FEIN BENEFITS







- + Ideally suited for trimming pipes and shaped section made of steel, cast-iron, autoclaved aerated concrete and plastics.
- + Clamp and feed device available for profiles and pipes from Ø 80 mm to Ø 400 mm.
- + Especially suitable for sandwich material and layers of different materials.
- + Variable electronic speed control for optimum cutting speed.
- + Adjustable clamping devices permit mitre cuts up to 45° as well.
- * With chain extension.

SAW BLADES

	NF metals and steel 400 N/mm ²	Steel above 400 N/mm ² and grey cast iron	Miscellaneous	Length mm	Tooth spacing mm	Thickness mm	Weight (net) kg	Material	Part number
	x	x	≤ dia. 80	200	1.0	1.5	0.06	HSS	6 35 03 067 00 6
	x	x	≤ dia. 80	200	1.6	1.5	0.06	HSS	6 35 03 066 00 2
	x	x	≤ dia. 170 ¹	300	1.6	1.5	0.06	HSS	6 35 03 063 00 7
	x	x	≤ dia. 260 ¹	400	1.6	1.5	0.125	HSS	6 35 03 064 00 5
	x	x	≤ dia. 350 ²	500	1.8	2.0	0.18	HSS	6 35 03 072 00 2
	x	x	≤ dia. 440 ²	600	1.8	2.0	0.21	HSS	6 35 03 073 00 6
	x	x		300	2.1	1.5	0.08	HSS	6 35 03 070 00 0
	x		*	530	2.1	1.5	0.170	HSS	6 35 03 069 00 8
	x (AL)		Plastic	200	3.2	1.5	0.06	HSS	6 35 03 065 00 9
	x (AL)		Plastic	400	3.2	1.5	0.125	HSS	6 35 03 068 00 4
			PE pipes, porous concrete	300	6.3	1.5	0.08		6 35 03 071 00 9
			PE pipes, porous concrete *	530	6.3	1.5	0.170		6 35 03 040 00 3



HD SAW BLADES

Special saw blades for working with steel and stainless steel. HD saw blades deliver impressively long service lives and rapid sawing progress. They are well worth trying out.

	NF metals and steel 400 N/mm ²	Steel above 400 N/mm ² and grey cast iron	Miscellaneous	Length mm	Tooth spacing mm	Thickness mm	Weight (net) kg	Material	Part number
	x	x	≤ dia. 170 ¹	300	1.6	2.0	0.08	HSS	6 35 03 093 00 4
	x	x	≤ dia. 350 ²	500	1.8	2.0	0.18	HSS	6 35 03 099 00 5
	x	x	≤ dia. 325 *	530	2.1	1.6	0.17	HSS	6 35 03 100 00 6
	x	x	≤ dia. 260 ¹	400	2.1	2.0	0.175	HSS	6 35 03 094 00 2
	x	x	≤ dia. 260 ¹	400	3.2	2.0	0.175	HSS	6 35 03 095 00 6
	x	x	≤ dia. 440 ²	600	1.8	2.0	0.21	HSS	6 35 03 098 00 1

TD SAW BLADES

TD saw blades are suited to wet and dry cutting. They deliver impressively short cutting times and clean cutting results.

	For ductile cast-iron pipes, even with cement mortar lining and grey cast iron pipes.	Pipe diameter (DN) mm	Length mm	Lining length mm	Thickness mm	Weight kg	Part number
	x	80–150 ³	320	260	2.2	0.110	6 35 03 096 01 8
	x	80–300 ³	490	430	2.9	0.220	6 35 03 097 01 2

* only with saw blade guide 9 06 06 002 00 9

¹ with FEIN clamping and feed device 9 07 02 005 00 0 or clamping device 9 07 02 004 00 6

² only with chain extension up to diameter of 440 mm, chain 3 02 31 003 00 3 and bolt 3 02 16 130 00 4 are also needed

³ can only be used with FEIN clamping and feed device 9 07 02 005 00 0

GENERAL ACCESSORIES



CUTTING PASTE

Lubricating agents for working on sheet metals.

Part number

3 21 32 020 12 9



FEIN CLAMP AND FEED DEVICE

(W x D x H) 280 x 285 x 395 mm, for pipes and circular material with an outside dia. of 80 mm to 400 mm.

Part number

9 07 02 005 00 0



CLAMPING FIXTURE

For pipes up to Ø 159 mm and for mitre cuts.

Part number

9 07 02 001 00 1



CLAMPING FIXTURE

For pipes from Ø 100 mm up to 325 mm, only with extension of the chain up to Ø 440 mm, chain 3 02 31 003 00 3 and bolt 3 02 16 130 00 4 necessary.

Part number

9 07 02 004 00 6



CLAMPING FIXTURE

For profiles up to 290 mm width at max height 550 mm.

Part number

9 07 02 003 00 8



SAW BLADE GUIDE

For pipes up to Ø 325 mm only with saw blade 530 mm length, guide to the centre of the pipe.

Part number

9 06 06 002 00 9

SPLITTER WEDGE

Prevents the jamming of the saw blade.

Part number

6 33 05 006 00 8

PROTECTIVE STEEL JAWS

for avoiding damage to the surface of the pipe, 4 pieces required

Part number

3 13 27 064 00 8



CLEANING BLOCK

Rhombus for cleaning the carbide tools and diamond-coated tools.

Part number

6 37 19 007 01 0

ACCESSORY STS 325 R

HOSE COUPLING

Part number

4 11 40 004 00 7

MKAS 355



Saw safely with speed and precision with the chop saw for metal.

Current/Voltages	V	230
Input	W	1 800
Output	W	1 050
Speed, no load	rpm	1,300
Saw blade Ø	mm	355
Holder mandrel	mm	25,4
Max. cutting depth, square	mm	120
Max. cutting depth, square at 45°	mm	90
Max. cutting depth, round	mm	100
Max. cutting depth, round at 45°	mm	90
Cable with plug	m	4
Weight	kg	24,4

FEIN BENEFITS

- + Up to 100 % non-sparking: cold cuts for safe working without dust.
- + Fast and precise dividing: maximum work progress with minimal rework.
- + A versatile all-rounder: the right saw blade for every material.
- + Angle can be set to 0–45° for mitre cuts.
- + Quick clamping device for table clamp.
- + Depth stop
- + Swarf collecting vessel.
- + Dead man's switch.

SUPPLIED

1 saw blade for construction steel,
1 combination wrench: 6 mm hexagon socket and PH2 cross recess, 1 socket head wrench 8 mm

For accessories, see page 145

Part number	7 236 54 60 00 0
EAN	4014586894447



GENERAL ACCESSORIES



SAW BLADE

For construction steel.

Ø mm	Teeth	Thickness mm	Part number
355	66	2,2	6 35 02 301 00 0

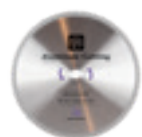

SAW BLADE

For aluminium.

Ø mm	Teeth	Thickness mm	Part number
355	80	2,8	6 35 02 302 00 0



SAW BLADE

For stainless steel.

Ø mm	Teeth	Thickness mm	Part number
355	90	2,4	6 35 02 303 00 0



SAW BLADE

For flat steel.

Ø mm	Teeth	Thickness mm	Part number
355	90	2,4	6 35 02 304 00 0



MAGBRUSH

Practical tool with high magnetic force for quick and easy collection of magnetic metal swarf.

Part number	6 42 01 005 01 0
-------------	------------------



CUTTING PASTE

Lubricating agents for working on sheet metals.

Part number	3 21 32 020 12 9
-------------	------------------



AKFH 18-5 SELECT	KFH 17-8 R	KFH 17-15 R
Powerful cordless beveler for perfectly preparing subsequent coatings for flexible jobs in the workshop and on the construction site.	Universal beveler with booster technology for perfectly preparing welded seams and preparing subsequent coatings.	Universal beveler with booster and spring technology for perfectly preparing welded seams.

PAGE		147	147	147
Installation work		++	+	+
Bevel length of up to 5 mm at 45°		+	++	++
Bevel length of up to 8 mm at 45°			+	++
Bevel length of up to 15 mm at 45°				+
Workshop jobs		+	++	++
Soft start		•	•	•
Restart protection		•	•	•
Blockage monitoring		•	•	•
Electronic overload protection		•	•	•
Speed preselection		•	•	•
Booster technology			•	•
Spring technology				•
Quick-change cutter system			•	•
Input	W		1 700	1 700
Output	W		1 000	1 000
Battery voltage	V	18		
Battery compatibility		Li-ion/HighPower Li-ion		
Battery interface		18 V		
Speed, no load	rpm	2,400 - 7,500	2,300 - 7,500	2,300 - 7,500
Max. bevel length at 45°	mm	5	8	15
Max. bevel height at 45°	mm	3,5	5,7	10,6
Radius		1,2 / 2,5 mm	2 / 3 / 4 mm	2 / 3 / 4 mm
Support plate diameter	mm	98	118	137
Bevel angle		45°	30° / 37,5° / 45° / 60°	30° / 37,5° / 45° / 60°
Milling head configuration		3x SX tip	3x KX tip	3 x 2 KX tip
Weight according to EPTA	kg		4,6	6,4
Weight without storage battery	kg	2,4		

+ suitability ++ optimal suitability • included



AKFH 18-5



KFH 17-8 R



KFH 17-15 R

AKFH 18-5 SELECT**SUPPLIED**

1 tool incl. 45 milling head (without guide roller, without indexable tips), 3 x clamping screws, 1 x copper paste, 1 x 4 mm socket head wrench, 1 x TX 15 Torx screwdriver, 1 plastic carrying case

For accessories, see page 148

Powerful cordless beveler for perfectly preparing subsequent coatings for flexible jobs in the workshop and on the construction site.

Battery voltage	V	18
Battery compatibility		Li-ion/ HighPower Li-ion
Battery interface		18 V
Speed, no load	rpm	2,400 - 7,500
Max. bevel length at 45°	mm	5
Max. bevel height at 45°	mm	3,5
Bevel angle		45°
Radius		1.2 / 2,5 mm
Milling head configuration		3x SX tip
Support plate diameter	mm	98
Weight without storage battery	kg	2,4

Part number	7 138 01 61 00 0
EAN	4014586892665

FEIN BENEFITS

- + For the production of bevels and radii on flat materials, sheet metals and containers, of inner and outer edges, contour shapes and for rounding off holes.
- + High sanding capacity requiring little force and infinitely variable speed setting for different materials.
- + Ergonomic thanks to low weight and compact design.
- + FEIN PowerDrive motor delivers good performance and long service life.
- + Extensive user protection features include soft start, restart protection, jam monitoring and electronic overload protection.

KFH 17-8 R**SUPPLIED**

1 tool (without milling head, without guide roller, without indexable tips), 3 x clamping screws, 1 x copper paste, 1 socket head wrench 5 mm, 1 x TX 15 Torx screwdriver, 1 plastic carrying case

For accessories, see page 148

Universal beveler with booster technology for perfectly preparing welded seams and preparing subsequent coatings.

Input	W	1 700
Output	W	1 000
Speed, no load	rpm	2,300 - 7,500
Max. bevel length at 45°	mm	8
Max. bevel height at 45°	mm	5,7
Bevel angle		30° / 37,5° / 45° / 60°
Radius		2 / 3 / 4 mm
Milling head configuration		3x KX tip
Support plate diameter	mm	118
Cable with plug	m	4
Weight according to EPTA	kg	4,6

Part number	7 238 16 61 00 0
EAN	4014586892696

FEIN BENEFITS

- + Milling performance improved by 30 - 80 % and vastly reduced vibrations thanks to new booster technology.
- + FEIN ErgoGrip: unique, ergonomic concept of two-handed operation for fatigue-free working (patent pending).
- + Efficient quick-change cutter system for minimal interruptions.
- + Effective material removal requiring little force.
- + Extensive user protection features include soft start, restart protection, jam monitoring and electronic overload protection.

KFH 17-15 R**SUPPLIED**

1 tool (without milling head, without guide roller, without indexable tips), 6 x clamping screws, 1 x copper paste, 1 socket head wrench 5 mm, 1 x TX 15 Torx screwdriver, 1 plastic carrying case

For accessories, see page 148

Universal beveler with booster and spring technology for perfectly preparing welded seams.

Input	W	1 700
Output	W	1 000
Speed, no load	rpm	2,300 - 7,500
Max. bevel length at 45°	mm	15
Max. bevel height at 45°	mm	10,6
Bevel angle		30° / 37,5° / 45° / 60°
Radius		2 / 3 / 4 mm
Milling head configuration		3 x 2 KX tip
Support plate diameter	mm	137
Cable with plug	m	4
Weight according to EPTA	kg	6,4

Part number	7 238 18 61 00 0
EAN	4014586892733

FEIN BENEFITS

- + Milling performance improved by 30 - 80 % and vastly reduced vibrations thanks to new booster technology.
- + Spring technology: absorption of rotational forces and therefore improved operational safety from low-vibration working.
- + FEIN ErgoGrip: unique, ergonomic concept of two-handed operation for fatigue-free working (patent pending).
- + Extensive user protection features include soft start, restart protection, jam monitoring and electronic overload protection.
- + Efficient quick-change cutter system for minimal interruptions.
- + Effective material removal requiring little force.

GENERAL ACCESSORIES



WORK GLOVES
Vibration-attenuating, certified according to EN 388/420, EN ISO 10819, EEC No. 0200, No. in pack 1 pair.

Size	Part number
9 L	3 21 73 003 00 3
10 XL	3 21 73 004 00 1
11 XXL	3 21 73 005 00 5



CORDLESS ALED 12-18 V LED LAMP
Compact and durable cordless LED lamp with swivel-mounted lamp head. Compatible with all 12 / 14 / 18 V FEIN Li-ion batteries, including hook for attaching the lamp. Extremely lightweight at 130 g and very bright at 900 Lux. Colour temperature is the equivalent of daylight. The brightness can be set to 2 levels.

Part number	9 26 04 200 02 0
-------------	------------------



AUSB 12-18 V CORDLESS USB ADAPTER
Compact cordless USB adapter for charging smartphones, tablets etc. without a mains connection. 2 high-speed USB charging ports for rapid charging at 2x 1.2 amps. Suitable for iOS and Android. Compatible with all 12 / 14 / 18 V FEIN Li-ion batteries.

Part number	9 26 04 201 02 0
-------------	------------------



QUICK CHARGER ALG 80 BC
Bluetooth® connectivity for connecting to a mobile end device and for use with the my.FEIN app. Shows the current charge state and the number of charge cycles to date on your smartphone or tablet. Provides notification when the battery is fully charged. Short charge times thanks to high charge current of 8 amps and process-controlled charge management. Large LED display with charge indicator and USB port for mobile charging of small electrical devices. For all FEIN Li-ion batteries. Charge times (80 % of max. capacity): 12 and 18 V / 3 Ah: 31 min., 12 and 18 V / 6 Ah: 38 min., 18 V / 5.2 Ah: 33 min.

Part number	9 26 04 210 01 0
-------------	------------------

18 V BATTERY



HIGHPOWER BATTERY PACK
HighPower Li-ion battery with cells capable of handling high currents, charge status indicator and FEIN SafetyCell technology. Continually high power output with 75 % higher current rating than a Li-ion battery. Recommended for FEIN cordless magnetic core drills and cordless angle grinders. Can be used with all FEIN 18 V cordless tools.

Current/Voltages V	Capacity Ah	Weight kg	Part number
18	5,2	0,75	9 26 04 179 02 0



HIGHPOWER BATTERY STARTER SET
2 HighPower Li-ion batteries with ALG 80 rapid charger. Bluetooth® connectivity for connecting to a mobile end device and for use with the my.FEIN app. Shows the current charge state and the number of charge cycles to date on your smartphone or tablet. Provides notification when the battery is fully charged. Short charge times thanks to high charge current of 8 amps and process-controlled charge management. Large LED display with charge indicator and USB port for mobile charging of small electrical devices. For all FEIN Li-ion batteries. Charge times (80 % of max. capacity): 12 and 18 V / 3 Ah: 31 min., 12 and 18 V / 6 Ah: 38 min., 18 V / 5.2 Ah: 33 min.

Current/Voltages V	Capacity Ah	Part number
18	5,2	9 26 04 325 01 0

ACCESSORY AKFH 18-5



SX INDEXABLE TIP
Bevel for universal use (steel, stainless steels which can be milled).

No. in pack pcs	Part number
10	6 43 02 001 01 0



SX INDEXABLE TIP
Bevel for non-ferrous metals and soft materials (aluminium, copper, plastics,...).

No. in pack pcs	Part number
10	6 43 02 007 01 0



SX INDEXABLE TIP
1.2 mm radius for universal use (steel, stainless steels which can be milled).

No. in pack pcs	Part number
10	6 43 02 008 01 0



SX INDEXABLE TIP
1.2 mm radius for non-ferrous metals and soft materials (aluminium, copper, plastics,...).

No. in pack pcs	Part number
10	6 43 02 009 01 0



SX INDEXABLE TIP
2.5 mm radius for universal use (steel, stainless steels which can be milled).

No. in pack pcs	Part number
10	6 43 02 002 01 0



SX INDEXABLE TIP
2.5 mm radius for non-ferrous metals and soft materials (aluminium, copper, plastics,...).

No. in pack pcs	Part number
10	6 43 02 010 01 0



SX CLAMPING SCREW
For SX indexable tip.

No. in pack pcs	Part number
10	3 13 50 076 00 0



GUIDE ROLLER
19.80 mm diameter for 45° bevel and 1.2 mm radius. In order to be able to use the two radius-cutting edges in each position (8x), both guide rollers (small and large diameters) are needed so that the indexable radius cutter can then be used 16 times.

Part number	6 43 03 006 01 0
-------------	------------------



GUIDE ROLLER
26.10 mm diameter for 45° bevel and 1.2 mm radius. In order to be able to use the two radius-cutting edges in each position (8x), both guide rollers (small and large diameters) are needed so that the indexable radius cutter can then be used 16 times.

Part number	6 43 03 007 01 0
-------------	------------------



GUIDE ROLLER
21.69 mm diameter for 45° bevel and 2.5 mm radius.

Part number	6 43 03 001 01 0
-------------	------------------

ACCESSORY KFH 17-8 R**CUTTER**

Tool with 3 cutters for 30° bevel.

Part number
6 43 01 002 01 0**CUTTER**

Tool with 3 cutters for 45° bevel and radius.

Part number
6 43 01 001 01 0**CUTTER**

Tool with 3 cutters for 60° bevel.

Part number
6 43 01 007 01 0**ACCESSORY KFH 17-15 R****CUTTER**

Tool with 3 x 2 cutters for 30° bevel.

Part number
6 43 01 004 01 0**CUTTER**

Tool with 3 x 2 cutters for 45° bevel and radius.

Part number
6 43 01 003 01 0**CUTTER**

Tool with 3 x 2 cutters for 60° bevel.

Part number
6 43 01 008 01 0**ACCESSORY KFH 17-8 R, KFH 17-15 R****KX INDEXABLE TIP**

Chamfer for high-strength steels, fine-grained steels, special steels.

No. in pack
pcs
10Part number
6 43 02 011 01 0**KX INDEXABLE TIP**

Bevel for non-ferrous metals and soft materials (aluminium, copper, plastics,..).

No. in pack
pcs
10Part number
6 43 02 003 01 0**KX INDEXABLE TIP**

Bevel for universal use (steel, stainless steels which can be milled).

No. in pack
pcs
10Part number
6 43 02 004 01 0**KX INDEXABLE TIP**

2 mm radius for high-strength steels, fine-grained steels, special steels.

No. in pack
pcs
10Part number
6 43 02 013 01 0**KX INDEXABLE TIP**

2 mm radius for non-ferrous metals and soft materials (aluminium, copper, plastics,..).

No. in pack
pcs
10Part number
6 43 02 018 01 0**KX INDEXABLE TIP**

2 mm radius for universal use (steel, stainless steels which can be milled).

No. in pack
pcs
10Part number
6 43 02 012 01 0**KX INDEXABLE TIP**

3 mm radius for high-strength steels, fine-grained steels, special steels.

No. in pack
pcs
10Part number
6 43 02 014 01 0**KX INDEXABLE TIP**

3 mm radius for non-ferrous metals and soft materials (aluminium, copper, plastics,..).

No. in pack
pcs
10Part number
6 43 02 005 01 0**KX INDEXABLE TIP**

3 mm radius for universal use (steel, stainless steels which can be milled).

No. in pack
pcs
10Part number
6 43 02 006 01 0**KX INDEXABLE TIP**

4 mm radius for high-strength steels, fine-grained steels, special steels.

No. in pack
pcs
10Part number
6 43 02 017 01 0**KX INDEXABLE TIP**

4 mm radius for non-ferrous metals and soft materials (aluminium, copper, plastics,..).

No. in pack
pcs
10Part number
6 43 02 016 01 0**KX INDEXABLE TIP**

4 mm radius for universal use (steel, stainless steels which can be milled).

No. in pack
pcs
10Part number
6 43 02 015 01 0**KX CLAMPING SCREW**

For KX indexable tip.

No. in pack
pcs
10Part number
3 13 50 075 00 0



GUIDE ROLLER

29.90 mm diameter for 30° and 37.5° bevel; no radius.

Part number

6 43 03 002 01 0



GUIDE ROLLER

26.30 mm diameter for 45° bevel; no radius.

Part number

6 43 03 003 01 0



GUIDE ROLLER

25.00 mm diameter for 60° bevel; no radius.

Part number

6 43 03 008 01 0



GUIDE ROLLER

26.65 mm diameter for 45° bevel and 2 mm radius.
In order to be able to use the two radius-cutting edges in each position (8x), both guide rollers (small and large diameters) are needed so that the indexable radius cutter can then be used 16 times.

Part number

6 43 03 009 01 0



GUIDE ROLLER

32.30 mm diameter for 45° bevel and 2 mm radius.
In order to be able to use the two radius-cutting edges in each position (8x), both guide rollers (small and large diameters) are needed so that the indexable radius cutter can then be used 16 times.

Part number

6 43 03 010 01 0



GUIDE ROLLER

28.55 mm diameter for 45° bevel and 3 mm radius.

Part number

6 43 03 004 01 0



GUIDE ROLLER

27.55 mm diameter for 45° bevel and 4 mm radius.

Part number

6 43 03 011 01 0

AKFH 18-5

5 mm
0.197 in

6 43 02 001 01 0

1,2 mm
0.047 in

6 43 02 008 01 0

2,5 mm
0.098 in

6 43 02 002 01 0

5 mm
0.197 in

6 43 02 007 01 0

1,2 mm
0.047 in

6 43 02 009 01 0

2,5 mm
0.098 in

6 43 02 010 01 0

1,2 mm
0.047 in

7,2 mm
0.283 in

Ø 19,80 mm

6 43 03 006 01 0

1,2 mm
0.047 in

2,7 mm
0.106 in

Ø 26,10 mm

6 43 03 007 01 0

2,5 mm
0.098 in

5 mm
0.197 in

Ø 21,69 mm

6 43 03 001 01 0

SX

10 x

3 13 50 076 00 0

KFH 17-8 R



8 mm
0.315 in

6 43 02 004 01 0

2 mm
0.079 in

6 43 02 012 01 0

3 mm | 0.118 in
6 43 02 006 01 0

4 mm | 0.157 in
6 43 02 015 01 0

8 mm
0.315 in

6 43 02 003 01 0

2 mm
0.079 in

6 43 02 018 01 0

3 mm | 0.118 in
6 43 02 005 01 0

4 mm | 0.157 in
6 43 02 016 01 0

8 mm
0.315 in

6 43 02 011 01 0

2 mm
0.079 in

6 43 02 013 01 0

3 mm | 0.118 in
6 43 02 014 01 0

4 mm | 0.157 in
6 43 02 017 01 0

8 mm
0.315 in

Ø 29,90 mm
6 43 03 002 01 0

2 mm
0.079 in

8 mm
0.315 in

Ø 26,65 mm
6 43 03 009 01 0

8 mm
0.315 in

Ø 26,30 mm
6 43 03 003 01 0

2 mm
0.079 in

4 mm
0.157 in

Ø 32,30 mm
6 43 03 010 01 0

7,4 mm
0.291 in

Ø 25,00 mm
6 43 03 008 01 0

3 mm
0.118 in

6,2 mm
0.244 in

Ø 28,55 mm
6 43 03 004 01 0

4 mm
0.157 in

7,5 mm
0.295 in

Ø 27,55 mm
6 43 03 011 01 0

KX

10 x

3 13 50 075 00 0

KFH 17-15 R



15 mm
0.590 in

6 43 02 004 01 0

2 mm
0.079 in

6 43 02 012 01 0

3 mm | 0.118 in
6 43 02 006 01 0

4 mm | 0.157 in
6 43 02 015 01 0

15 mm
0.590 in

6 43 02 003 01 0

2 mm
0.079 in

6 43 02 018 01 0

3 mm | 0.118 in
6 43 02 005 01 0

4 mm | 0.157 in
6 43 02 016 01 0

15 mm
0.590 in

6 43 02 011 01 0

2 mm
0.079 in

6 43 02 013 01 0

3 mm | 0.118 in
6 43 02 014 01 0

4 mm | 0.157 in
6 43 02 017 01 0

15 mm
0.590 in

Ø 29,90 mm
6 43 03 002 01 0

2 mm
0.079 in

16,8 mm
0.661 in

Ø 26,65 mm
6 43 03 009 01 0

15 mm
0.590 in

Ø 26,30 mm
6 43 03 003 01 0

2 mm
0.079 in

13 mm
0.512 in

Ø 32,30 mm
6 43 03 010 01 0

16 mm
0.630 in

Ø 25,00 mm
6 43 03 008 01 0

3 mm
0.118 in

14 mm
0.551 in

Ø 28,55 mm
6 43 03 004 01 0

4 mm
0.157 in

16,2 mm
0.638 in

Ø 27,55 mm
6 43 03 011 01 0

KX

10 x

3 13 50 075 00 0

SAWING AND CUTTING

FEIN pipe milling cutters – cost-effective pipe machining with high cutting performance.

The pipe cutting industry the world over is familiar with FEIN pipe milling machines. They can be used for everything from cutting to length before laying to cutting pipes which have already been laid. In addition, the FEIN pipe milling machines boast impressive, robust quality and

outstanding efficiency. They are ideally suited to machining cast pipes or steel pipes for oil, gas and water supplies that are used in pipelines, public supply networks, power plants, industrial systems and container construction, for example. Optimised technology ensures good cutting performance.

Tried and tested technology for perfect results.

The system comes into its own under tough conditions, e.g. pipe fractures.

Adapting to different pipe materials by selecting the right gear ratio produces ideal cutting and feed speeds, enabling the cost-effective use of HSS and carbide tools.

Key advantages at a glance:

- + Robust tool design, powerful motors and high-quality materials make the tool ideal for use under extreme conditions.
- + Electric pipe milling machines can even be used at very low sub-zero temperatures.
- + Electric pipe milling machines with feed and return (return only in load-free operation).
- + Can be used flexibly for pipes of between 250 mm and 3 000 mm.
- + Profile and separating cuts with form cutter or saw blade.
- + Precise directional stability and exact cut thanks to the two-chain system, adjustable track setting and double chain tension.
- + Crack-free pipe ends deliver perfect results when welding. Reason: perfect cutting and sawing results are achieved due to the good sanding capacity, high tool quality and the fact that there is no misalignment.
- + Easy installation thanks to optimised handling.
- + Available in two gearbox variants: different feed and speed levels guarantee a cutting speed to suit various materials (recommendation: steel pipe – slow cutting speed, cast pipe – fast cutting speed).
- + Precise and safe working as feed can be switched off and shut down (RSG/RDG 1 500 pipe milling cutters).
- + Tool is shut down by slipping clutch, meaning that it is protected when the gearbox is overloaded.
- + Extensive FEIN accessories range.





Overview of tools



FEIN electric pipe milling machines:

Protection class I. Protection code IP X4.

In conjunction with the controlgear combination:

+ Self-start lock ensures safe operations.

+ Overload protection for the three-phase motor.

Produced and tested in accordance with EN 62841.

RSG VERSION:

+ For universal use.

+ Three-phase motor with protection from explosion and moisture.

RSG EX VERSION:

+ Particularly well suited for cutting oil and gas pipes not transporting material.

+ Three-phase motor with protection from explosion and moisture with additional switch with explosion protection.

FEIN pneumatic pipe milling machines:

RDG VERSION:

+ Protection for work on water, oil and gas pipes not transporting material thanks to pneumatic drive.

+ Suitable for use in potable water applications.

+ Motor drive parts made from stainless material.

+ The compressed air motor's fins are resistant to swelling.

+ Can even run dry for brief periods.

**WE ARE MORE THAN HAPPY TO PROVIDE
TECHNICAL ADVICE.**



METAL CORE DRILLING

ECONOMICAL **156**

Economical magnetic core drills with basic functionality for drilling, which do not compromise on lifetime or performance.

COMPACT **159**

Compact magnetic core drills with minimum dimensions for core drilling in tight and difficult-to-reach spots.

UNIVERSAL **164**

High-performance universal magnetic core drills with very high quality standards for universal applications.

AUTOMATIC **174**

High-performance, fully automatic auto magnetic core drills for maximum efficiency and minimum physical strain.



KBE 30 **KBE 32** **KBE 32 QW** **KBE 35** **KBE 50-2**

Small and extremely lightweight single-speed economical magnetic core drill with basic functionality for core drilling on the construction site.

Small and powerful single-speed Eco magnetic core drill with basic functionality for core drilling and twist drilling on the construction site.

Lightweight and powerful 2-speed Eco magnetic core drill with basic functionality for core drilling and twist drilling in the workshop and on the construction site.

PAGE		157	157	157	158	158
Core drilling in metal with a Ø up to 35 mm		++	++	++	++	++
Core drilling in metal with a Ø up to 50 mm						++
Twist drills with drill chuck (DIN 338)					++	++
Working overhead		++	++	++	++	+
Installation work		++	++	++	++	++
Workshop jobs		++	++	++	++	++
Feed handwheel can be moved from one side to the other		•	•	•	•	•
Tool-free core bit fast change system				•		
Input	W	750	1200	1200	850	1100
Output	W	430	770	770	450	650
Speed, full load	rpm	430	450	450	460	
Load speed in speed 1	rpm					260
Load speed in speed 2	rpm					520
Speed, no load	rpm	740	700	700	620	
Idling speed in speed 1	rpm					330
Idling speed in speed 2	rpm					650
Carbide core drill bit max. Ø	mm	30	32	32	35	50
HSS core drill max. Ø	mm	30	32	32	35	50
Core drill, drilling depth max.	mm	50	50	50	50	50
Twist drill max. Ø	mm				13	16
Core drill holder		3/4" Weldon	3/4" Weldon	3/4" Weldon	3/4" Weldon	3/4" Weldon
Stroke	mm	65	90	90	135	135
Magnetic holding power	N	9,000	10,000	10,000	12,000	12,000
Magnetic foot dimensions	mm	178 x 95	175 x 80	175 x 80	195 x 90	195 x 90
Cable with plug	m	3	3	3	3	3
Weight according to EPTA	kg	10,5	10,8	11	11,8	12,5

+ suitability ++ optimal suitability • included

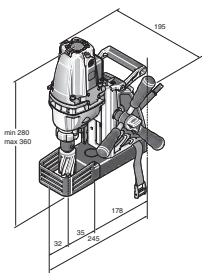

KBE 30



KBE 32



KBE 32 QW

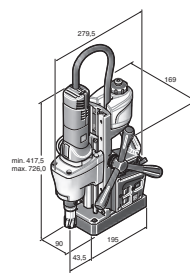

KBE 35

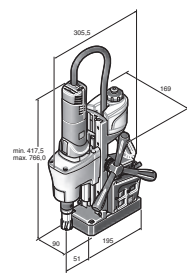

KBE 50-2

KBE 30**SUPPLIED**

1 coolant tank, 1 lashing strap,
1 centring pin 100 mm, 1 contact
guard, 1 socket head wrench 5 mm

For accessories, see page 160

Small and extremely lightweight single-speed economical magnetic core drill with basic functionality for core drilling on the construction site.

Input	W	750
Output	W	430
Speed, full load	rpm	430
Speed, no load	rpm	740
Carbide core drill bit max. Ø	mm	30
HSS core drill max. Ø	mm	30
Core drill, drilling depth max.	mm	50
Core drill holder		3/4" Weldon
Stroke	mm	65
Magnetic holding power	N	9,000
Magnetic foot dimensions	mm	178 x 95
Cable with plug	m	3
Weight according to EPTA	kg	10,5

FEIN BENEFITS

- + For tough use thanks to the outstanding quality of workmanship and the internal motor cable guide.
- + Lightweight with FEIN high-power motor and high torque for all core drilling tasks
- + Uncompromising with regard to service life and work progress coupled with outstanding value for money.
- + Internal cooling.
- + High magnetic holding force.
- + Feed handwheel can be moved from one side to the other.
- + Personal safety switch.

Part number	7 270 65 60 00 0
EAN	4014586889597

KBE 32**SUPPLIED**

1 hand pump, 1 bottle holder,
1 lashing strap, 1 centring pin
100 mm, 1 contact guard, 1 socket
head wrench 5 mm, 1 case

For accessories, see page 160

Small and extremely lightweight single-speed economical magnetic core drill with basic functionality for core drilling on the construction site.

Input	W	1 200
Output	W	770
Speed, full load	rpm	450
Speed, no load	rpm	700
Carbide core drill bit max. Ø	mm	32
HSS core drill max. Ø	mm	32
Core drill, drilling depth max.	mm	50
Core drill holder		3/4" Weldon
Stroke	mm	90
Magnetic holding power	N	10,000
Magnetic foot dimensions	mm	175 x 80
Cable with plug	m	3
Weight according to EPTA	kg	10,8

FEIN BENEFITS

- + For tough use thanks to the outstanding quality of workmanship and the internal motor cable guide.
- + Extremely durable gearbox design offering an operating time of up to 400 hours for an uncompromising service life.
- + Lightweight with FEIN high-power motor and high torque for all core drilling tasks
- + Excellent price / performance ratio.
- + Internal cooling.
- + High magnetic holding force.
- + Feed handwheel can be moved from one side to the other.
- + Good accessibility in cramped operating situations.
- + Personal safety switch.

Part number	7 270 94 61 00 0
EAN	4014586894539

KBE 32 QW**SUPPLIED**

1 hand pump, 1 bottle holder,
1 lashing strap, 1 centring pin
100 mm, 1 contact guard, 1 case

For accessories, see page 160

Small and extremely lightweight single-speed economical magnetic core drill with basic functionality for core drilling on the construction site.

Input	W	1 200
Output	W	770
Speed, full load	rpm	450
Speed, no load	rpm	700
Carbide core drill bit max. Ø	mm	32
HSS core drill max. Ø	mm	32
Core drill, drilling depth max.	mm	50
Core drill holder		3/4" Weldon
Changing the core bit		tool-free
Stroke	mm	90
Magnetic holding power	N	10,000
Magnetic foot dimensions	mm	175 x 80
Cable with plug	m	3
Weight according to EPTA	kg	11

FEIN BENEFITS

- + For tough use thanks to the outstanding quality of workmanship and the internal motor cable guide.
- + Extremely durable gearbox design offering an operating time of up to 400 hours for an uncompromising service life.
- + Lightweight with FEIN high-power motor and high torque for all core drilling tasks
- + Excellent price / performance ratio.
- + Tool-free core bit quick change system.
- + Internal cooling.
- + High magnetic holding force.
- + Feed handwheel can be moved from one side to the other.
- + Good accessibility in cramped operating situations.
- + Personal safety switch.

Part number	7 270 95 61 00 0
EAN	4014586894614

KBE 35

Small and powerful single-speed Eco magnetic core drill with basic functionality for core drilling and twist drilling on the construction site.

**SUPPLIED**

1 coolant tank, 1 lashing strap, 1 centring pin 100 mm, 1 contact guard, 2 x 5 and 6 mm hexagon socket wrench

For accessories, see page 160

Input	W	850
Output	W	450
Speed, full load	rpm	460
Speed, no load	rpm	620
Carbide core drill bit max. Ø	mm	35
HSS core drill max. Ø	mm	35
Core drill, drilling depth max.	mm	50
Twist drill max. Ø	mm	13
Core drill holder		3/4" Weldon
Stroke	mm	135
Total stroke range	mm	260
Magnetic holding power	N	12,000
Magnetic foot dimensions	mm	195 x 90
Cable with plug	m	3
Weight according to EPTA	kg	11,8

Part number	7 270 50 60 00 0
EAN	4014586881584

FEIN BENEFITS

- + For tough use thanks to the outstanding quality of workmanship
- + FEIN high-power motor with high torque and large stroke range for core and twist drilling.
- + Uncompromising with regard to service life and work progress coupled with outstanding value for money.
- + Integrated coolant tank.
- + High magnetic holding force.
- + Optimum power-to-weight ratio.
- + Feed handwheel can be moved from one side to the other with hex hub.
- + Integrated Allen wrench holder.
- + Personal safety switch.

KBE 50-2

Lightweight and powerful 2-speed Eco magnetic core drill with basic functionality for core drilling and twist drilling in the workshop and on the construction site.

**SUPPLIED**

1 coolant tank, 1 lashing strap, 1 centring pin 100 mm, 1 contact guard, 2 x 5 and 6 mm hexagon socket wrench

For accessories, see page 160

Input	W	1 100
Output	W	650
Load speed in speed 1	rpm	260
Load speed in speed 2	rpm	520
Idling speed in speed 1	rpm	330
Idling speed in speed 2	rpm	650
Carbide core drill bit max. Ø	mm	50
HSS core drill max. Ø	mm	50
Core drill, drilling depth max.	mm	50
Twist drill max. Ø	mm	16
Core drill holder		3/4" Weldon
Stroke	mm	135
Total stroke range	mm	260
Magnetic holding power	N	12,000
Magnetic foot dimensions	mm	195 x 90
Cable with plug	m	3
Weight according to EPTA	kg	12,5

Part number	7 270 51 60 00 0
EAN	4014586881645

FEIN BENEFITS

- + For tough use thanks to the outstanding quality of workmanship
- + FEIN high-power motor with high torque and large stroke range for core and twist drilling.
- + Uncompromising with regard to service life and work progress coupled with outstanding value for money.
- + Mechanical 2-speed gearbox.
- + Integrated coolant tank.
- + High magnetic holding force.
- + Optimum power-to-weight ratio.
- + Feed handwheel can be moved from one side to the other with hex hub.
- + Integrated Allen wrench holder.
- + Personal safety switch.



KBB 40

Extremely small single-speed compact magnetic core drill with fixed drill motor for core drilling in tight spaces in the workshop and on the construction site.

PAGE		160
Core drilling in metal with a Ø up to 35 mm		++
Core drilling in metal with a Ø up to 40 mm		++
Working overhead		++
Installation work		++
Workshop jobs		++
Input	W	1 100
Output	W	610
Speed, full load	rpm	280
Speed, no load	rpm	450
Carbide core drill bit max. Ø	mm	40
HSS core drill max. Ø	mm	40
Core drill, drilling depth max.	mm	50
Twist drill max. Ø	mm	16
Core drill holder		3/4" Weldon
Stroke	mm	65
Magnetic holding power	N	9,000
Magnetic foot dimensions	mm	165 x 102
Cable with plug	m	3,8
Weight according to EPTA	kg	12,8

++ optimal suitability

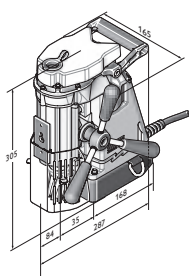

KBB 40

METAL
CORE DRILLING

KBB 40



SUPPLIED

1 coolant tank, 1 lashing strap, 1 swarf hook, 2 centering pins, 1 contact guard, 1 socket head wrench 5 mm, 1 case

For accessories, see page 160

Extremely small single-speed compact magnetic core drill with fixed drill motor for core drilling in tight spaces in the workshop and on the construction site.

Input	W	1 100
Output	W	610
Speed, full load	rpm	280
Speed, no load	rpm	450
Carbide core drill bit max. Ø	mm	40
HSS core drill max. Ø	mm	40
Core drill, drilling depth max.	mm	50
Twist drill max. Ø	mm	16
Core drill holder		3/4" Weldon
Width across corners	mm	46
Height	mm	305
Stroke	mm	65
Magnetic holding power	N	9,000
Magnetic foot dimensions	mm	165 x 102
Cable with plug	m	3,8
Weight according to EPTA	kg	12,8

FEIN BENEFITS

- + Extremely small and light for working in tight and difficult-to-reach spots - including vertically and overhead - thanks to height of 305 mm.
- + Extremely low wear and long-life tool design with spindle sleeve feed without clearance for accurate drilling results in tough use in industry and manual trades.
- + FEIN 1100 W high-power motor operates at constant speed for reliable and economical core drilling to a cutting depth of up to 50 mm.
- + Fixed drill motor for working in tight spaces.
- + High gearbox positioning for optimum view of the drilling point.
- + Feed handwheel can be moved from one side to the other for use in special work situations.
- + Integrated coolant tank.
- + Solid die-cast aluminium construction.
- + Personal safety switch.

Part number	7 272 03 61 00 0
EAN	4014586700502

BEST OF CORE DRILLING HSS ACCESSORY SET



BEST OF CORE BITS 3/4" WELDON

Industrial standard. Metric dimensions, cutting depth 25 mm. Set version, consisting of 4 core bits, 2 x 14 mm diameter, 2 x 18 mm diameter, (cutting depth 25 mm) and 1 centring pin (80 mm) in plastic case.

Part number
6 31 34 999 06 2



BEST OF CORE BITS 3/4" WELDON

Industrial standard. Metric dimensions, cutting depth 50 mm. Set version, consisting of 4 core bits, 2x 14 mm diameter, 2x 18 mm diameter, (cutting depth 50 mm) and 1 centring pin (100 mm) in plastic case.

Part number
6 31 34 999 06 4



BEST OF CORE BITS 3/4" WELDON

Industrial standard. Metric dimensions, cutting depth 25 mm. Set version, consisting of 6 core bits with diameters of 12, 14, 16, 18, 20 and 22 mm (cutting depth 25 mm) and 2 centring pins (80 mm) in plastic case.

Part number
6 31 34 999 06 1



BEST OF CORE BITS 3/4" WELDON

Industrial standard. Metric dimensions, cutting depth 50 mm. Set version, consisting of 6 core bits with diameters of 12, 14, 16, 18, 20 and 22 mm (cutting depth 50 mm) and 2 centring pins (100 mm) in plastic case.

Part number
6 31 34 999 06 3

BEST OF CORE DRILLING CARBIDE ACCESSORY SET



BEST OF CORE BITS 3/4" WELDON

Very long service life and outstanding cutting performance. Metric dimensions, cutting depth 35 mm. Set version, consisting of 6 core bits with diameters of 12, 14, 16, 18, 20 and 22 mm (cutting depth 35 mm) and 2 centring pins (100 mm) in plastic case.

Part number
6 31 27 714 02 0

CARBIDE CORE DRILL



TCT ULTRA 35 CORE BIT WITH 3/4" WELDON HOLDER

Very long service life and outstanding cutting performance. Metric dimensions, cutting depth 35 mm.

Cutting depth mm	Bore Ø mm	Part number
35	12	6 31 27 714 01 0
35	13	6 31 27 715 01 0
35	14	6 31 27 716 01 0
35	15	6 31 27 717 01 0
35	16	6 31 27 718 01 0
35	17	6 31 27 719 01 0
35	18	6 31 27 720 01 0
35	19	6 31 27 721 01 0
35	20	6 31 27 722 01 0
35	21	6 31 27 723 01 0
35	22	6 31 27 724 01 0
35	23	6 31 27 725 01 0
35	24	6 31 27 726 01 0
35	25	6 31 27 727 01 0
35	26	6 31 27 728 01 0
35	27	6 31 27 729 01 0
35	28	6 31 27 730 01 0
35	29	6 31 27 731 01 0
35	30	6 31 27 732 01 0
35	31	6 31 27 733 01 0
35	32	6 31 27 734 01 0
35	33	6 31 27 735 01 0

Cutting depth mm	Bore Ø mm	Part number
35	34	6 31 27 736 01 0
35	35	6 31 27 737 01 0
35	36	6 31 27 738 01 0
35	37	6 31 27 739 01 0
35	38	6 31 27 740 01 0
35	39	6 31 27 741 01 0
35	40	6 31 27 742 01 0
35	41	6 31 27 743 01 0
35	42	6 31 27 744 01 0
35	43	6 31 27 745 01 0
35	44	6 31 27 746 01 0
35	45	6 31 27 747 01 0
35	46	6 31 27 748 01 0
35	47	6 31 27 749 01 0
35	48	6 31 27 750 01 0
35	49	6 31 27 751 01 0
35	50	6 31 27 752 01 0



TCT ULTRA 50 CORE BIT WITH 3/4" WELDON HOLDER

Very long service life and outstanding cutting performance.
Metric dimensions, cutting depth 50 mm.

Cutting depth mm	Bore Ø mm	Part number
50	12	6 31 27 276 01 0
50	13	6 31 27 277 01 0
50	14	6 31 27 278 01 0
50	15	6 31 27 279 01 0
50	15,5	6 31 27 828 01 0
50	16	6 31 27 280 01 0
50	17	6 31 27 281 01 0
50	17,5	6 31 27 829 01 0
50	18	6 31 27 282 01 0
50	19	6 31 27 283 01 0
50	19,5	6 31 27 830 01 0
50	20	6 31 27 284 01 0
50	21	6 31 27 285 01 0
50	22	6 31 27 286 01 0
50	23	6 31 27 287 01 0
50	24	6 31 27 288 01 0
50	25	6 31 27 289 01 0
50	26	6 31 27 290 01 0
50	26,5	6 31 27 831 01 0
50	27	6 31 27 291 01 0
50	28	6 31 27 292 01 0
50	29	6 31 27 293 01 0
50	30	6 31 27 294 01 0
50	31	6 31 27 295 01 0
50	32	6 31 27 296 01 0
50	33	6 31 27 297 01 0
50	34	6 31 27 298 01 0
50	35	6 31 27 299 01 0
50	36	6 31 27 300 01 0
50	37	6 31 27 301 01 0
50	38	6 31 27 302 01 0
50	39	6 31 27 303 01 0
50	40	6 31 27 304 01 0
50	41	6 31 27 305 01 0
50	42	6 31 27 306 01 0
50	43	6 31 27 307 01 0
50	44	6 31 27 308 01 0
50	45	6 31 27 309 01 0
50	46	6 31 27 310 01 0
50	47	6 31 27 311 01 0
50	48	6 31 27 312 01 0
50	49	6 31 27 313 01 0
50	50	6 31 27 314 01 0

HSS CORE DRILL



HSS NOVA 25 CORE BIT WITH 3/4" WELDON HOLDER
Industrial standard. Metric dimensions, cutting depth 25 mm.

Cutting depth mm	Bore Ø mm	Part number
25	12	6 31 34 120 05 1
25	13	6 31 34 130 05 1
25	14	6 31 34 140 05 1
25	15	6 31 34 150 05 1
25	16	6 31 34 160 05 1
25	17	6 31 34 170 05 1
25	18	6 31 34 180 05 1
25	19	6 31 34 190 05 1
25	20	6 31 34 200 05 1
25	21	6 31 34 210 05 1
25	22	6 31 34 220 05 1
25	23	6 31 34 230 05 1
25	24	6 31 34 240 05 1
25	25	6 31 34 250 05 1
25	26	6 31 34 260 05 1
25	27	6 31 34 270 05 1
25	28	6 31 34 280 05 1
25	29	6 31 34 290 05 1
25	30	6 31 34 300 05 1
25	31	6 31 34 310 05 1
25	32	6 31 34 320 05 1
25	33	6 31 34 330 05 1
25	34	6 31 34 340 05 1
25	35	6 31 34 350 05 1
25	36	6 31 34 360 05 1
25	37	6 31 34 370 05 1
25	38	6 31 34 380 05 1
25	39	6 31 34 390 05 1
25	40	6 31 34 400 05 1
25	41	6 31 34 410 05 1
25	42	6 31 34 420 05 1
25	43	6 31 34 430 05 1
25	44	6 31 34 440 05 1
25	45	6 31 34 450 05 1
25	46	6 31 34 460 05 1
25	47	6 31 34 470 05 1
25	48	6 31 34 480 05 1
25	49	6 31 34 490 05 1
25	50	6 31 34 500 05 1



HSS NOVA 50 CORE BIT WITH 3/4" WELDON HOLDER
Industrial standard. Metric dimensions, cutting depth 50 mm.

Cutting depth mm	Bore Ø mm	Part number
50	12	6 31 34 120 05 2
50	13	6 31 34 130 05 2
50	14	6 31 34 140 05 2
50	15	6 31 34 150 05 2
50	16	6 31 34 160 05 2
50	17	6 31 34 170 05 2
50	18	6 31 34 180 05 2
50	19	6 31 34 190 05 2
50	20	6 31 34 200 05 2
50	21	6 31 34 210 05 2
50	22	6 31 34 220 05 2
50	23	6 31 34 230 05 2
50	24	6 31 34 240 05 2
50	25	6 31 34 250 05 2
50	26	6 31 34 260 05 2
50	27	6 31 34 270 05 2
50	28	6 31 34 280 05 2
50	29	6 31 34 290 05 2
50	30	6 31 34 300 05 2
50	31	6 31 34 310 05 2
50	32	6 31 34 320 05 2

Cutting depth mm	Bore Ø mm	Part number
50	33	6 31 34 330 05 2
50	34	6 31 34 340 05 2
50	35	6 31 34 350 05 2
50	36	6 31 34 360 05 2
50	37	6 31 34 370 05 2
50	38	6 31 34 380 05 2
50	39	6 31 34 390 05 2
50	40	6 31 34 400 05 2
50	41	6 31 34 410 05 2
50	42	6 31 34 420 05 2
50	43	6 31 34 430 05 2
50	44	6 31 34 440 05 2
50	45	6 31 34 450 05 2
50	46	6 31 34 460 05 2
50	47	6 31 34 470 05 2
50	48	6 31 34 480 05 2
50	49	6 31 34 490 05 2
50	50	6 31 34 500 05 2



HSS SPECIAL 25 CORE BIT WITH 3/4" WELDON FITTING
Long service life. For drilling multi-layered materials in a single process.

Cutting depth mm	Bore Ø mm	Part number
25	12	6 31 34 120 30 1
25	13	6 31 34 130 30 1
25	14	6 31 34 140 30 1
25	14,3	6 31 34 143 30 1
25	15	6 31 34 150 30 1
25	16	6 31 34 160 30 1
25	17	6 31 34 170 30 1
25	18	6 31 34 180 30 1
25	20	6 31 34 200 30 1
25	22	6 31 34 220 30 1
25	24	6 31 34 240 30 1
25	26	6 31 34 260 30 1
25	28	6 31 34 280 30 1
25	30	6 31 34 300 30 1
25	32	6 31 34 320 30 1
25	35	6 31 34 350 30 1



HSS DURA 25 CORE BIT WITH 3/4" WELDON HOLDER
TiN surface coating for outstanding service lives and the best glide properties.
Metric dimensions, cutting depth 25 mm.

Cutting depth mm	Bore Ø mm	Part number
25	12	6 31 34 120 07 5
25	13	6 31 34 130 07 5
25	14	6 31 34 140 07 5
25	15	6 31 34 150 07 5
25	16	6 31 34 160 07 5
25	17	6 31 34 170 07 5
25	18	6 31 34 180 07 5
25	19	6 31 34 190 07 5
25	20	6 31 34 200 07 5
25	21	6 31 34 210 07 5
25	22	6 31 34 220 07 5
25	23	6 31 34 230 07 5
25	24	6 31 34 240 07 5
25	25	6 31 34 250 07 5
25	26	6 31 34 260 07 5
25	27	6 31 34 270 07 5
25	28	6 31 34 280 07 5
25	29	6 31 34 290 07 5
25	30	6 31 34 300 07 5
25	31	6 31 34 310 07 5
25	32	6 31 34 320 07 5
25	33	6 31 34 330 07 5
25	34	6 31 34 340 07 5

Cutting depth mm	Bore Ø mm	Part number
25	35	6 31 34 350 07 5
25	36	6 31 34 360 07 5
25	37	6 31 34 370 07 5
25	38	6 31 34 380 07 5
25	39	6 31 34 390 07 5
25	40	6 31 34 400 07 5
25	41	6 31 34 410 07 5
25	42	6 31 34 420 07 5
25	43	6 31 34 430 07 5
25	44	6 31 34 440 07 5
25	45	6 31 34 450 07 5
25	46	6 31 34 460 07 5
25	47	6 31 34 470 07 5
25	48	6 31 34 480 07 5
25	49	6 31 34 490 07 5
25	50	6 31 34 500 07 5



HSS DURA 50 CORE BIT WITH 3/4" WELDON HOLDER
TiN surface coating for outstanding service lives and the best glide properties.
Metric dimensions, cutting depth 50 mm.

Cutting depth mm	Bore Ø mm	Part number
50	12	6 31 34 120 07 6
50	13	6 31 34 130 07 6
50	14	6 31 34 140 07 6
50	15	6 31 34 150 07 6
50	16	6 31 34 160 07 6
50	17	6 31 34 170 07 6
50	18	6 31 34 180 07 6
50	19	6 31 34 190 07 6
50	20	6 31 34 200 07 6
50	21	6 31 34 210 07 6
50	22	6 31 34 220 07 6
50	23	6 31 34 230 07 6
50	24	6 31 34 240 07 6
50	25	6 31 34 250 07 6
50	26	6 31 34 260 07 6
50	27	6 31 34 270 07 6
50	28	6 31 34 280 07 6
50	29	6 31 34 290 07 6
50	30	6 31 34 300 07 6
50	31	6 31 34 310 07 6
50	32	6 31 34 320 07 6
50	33	6 31 34 330 07 6
50	34	6 31 34 340 07 6
50	35	6 31 34 350 07 6
50	36	6 31 34 360 07 6
50	37	6 31 34 370 07 6
50	38	6 31 34 380 07 6
50	39	6 31 34 390 07 6
50	40	6 31 34 400 07 6
50	41	6 31 34 410 07 6
50	42	6 31 34 420 07 6
50	43	6 31 34 430 07 6
50	44	6 31 34 440 07 6
50	45	6 31 34 450 07 6
50	46	6 31 34 460 07 6
50	47	6 31 34 470 07 6
50	48	6 31 34 480 07 6
50	49	6 31 34 490 07 6
50	50	6 31 34 500 07 6

CENTERING PINS



CENTERING PIN

Ø mm	L mm	Part number
	80	3 02 17 359 00 0
6,35	82	6 31 34 998 30 0
6,35	100	6 31 34 998 31 0

ADAPTER/DRILL CHUCK

HSS TWIST DRILL WITH 3/4" WELDON FITTING
Cutting depth 35 mm

Bore Ø mm	Part number
5	6 31 11 036 01 0
6	6 31 11 018 01 0
6,8	6 31 11 034 01 0
7	6 31 11 019 01 0
8	6 31 11 020 01 0
8,5	6 31 11 035 01 0
9	6 31 11 021 01 0
10	6 31 11 022 01 0
10,2	6 31 11 037 01 0
11	6 31 11 023 01 0
12	6 31 11 024 01 0
13	6 31 11 025 01 0
14	6 31 11 026 01 0
15	6 31 11 027 01 0
16	6 31 11 028 01 0



HSS TWIST DRILL SET WITH 3/4" WELDON FITTING
Comprising 6 HSS twist drills (diameters of 6, 8, 10, 12, 14 and 16 mm) in a handy plastic storage box. Cutting depth 35 mm

Part number
6 31 11 018 02 0



ADAPTER WITH 3/4" WELDON FITTING
1/4" hexagonal output in accordance with DIN 3126/ISO 1173 – C 6.3

Part number
6 32 06 148 01 0



HSS 90° COUNTERSINK BIT
With 1/4" hexagon in accordance with DIN 3126/ISO 1173 – C 6.3

Ø mm	Part number
16,5	6 31 11 038 01 0



HSS 90° COUNTERSINK BIT WITH ADAPTER WITH 3/4" WELDON FITTING

Ø mm	Part number
16,5	6 31 11 038 02 0

CLAMPING FIXTURES

VACUUM PLATE
for anti-magnetic materials and structured bases (corrugated sheet, stud plate etc.)
Vacuum plate 396 x 200 x 95 mm

Part number
9 26 02 057 01 7



VACUUM PUMP
Suction rate 0,015 m³/min, -0,8 bar, 92 W, weight 2,5 kg including suction hose

Part number
9 26 01 022 01 3



SUCTION PLATE
for anti-magnetic materials, 250 x 330 x 110 mm

Part number
9 26 02 054 01 6



PIPE DRILLING DEVICE
incl. clamping strap, for positioning bores on pipes with pipe Ø of 60 to 300 mm, 220 x 130 mm.

Part number
9 26 02 055 01 0

COOLING

PUMP
Capacity approx. 450 ml.

Part number
3 21 32 022 00 7

REPLACEMENT HOSE
for hand pump 3 21 32 022 00 7.

Part number
3 14 14 054 00 8



CUTTING PASTE
Lubricating agents for working on sheet metals.

Part number
3 21 32 020 12 9



COOLANT TANK
Capacity approx. 500 ml. Scope for regulating the flow rate. Suitable for KBE 32 and KBE 32 QW.

Part number
3 21 31 038 02 0

OTHER ACCESSORIES

MAGBRUSH
Practical tool with high magnetic force for quick and easy collection of magnetic metal swarf.

Part number
6 42 01 005 01 0



CASE
Suitable for KBE 30.

Part number
3 39 98 140 13 0



CASE
Suitable for KBE 35, KBE 50-2, KBE 50-2 M, KBE 65-2 M.

Part number
3 39 01 142 14 0



	AKBU 35 PMQ SELECT	AKBU 35 PMQW SELECT	KBU 35 Q	KBU 35 PQ	KBU 35 QW	KBU 35 PQW	
	Small and powerful single-speed cordless universal magnetic core drill with forward/reverse running, MT2 tool mounting, permanent magnet and maximum functionality for mobile working on the construction site.		Small and powerful single-speed universal magnetic core drill with clockwise/anti-clockwise operation and maximum functionality for flexible working on the construction site.	Small and powerful single-speed universal magnetic core drill with clockwise/anti-clockwise operation, permanent magnet and maximum functionality for very safe and flexible working on the construction site.	Small and powerful single-speed universal magnetic core drill with clockwise/anti-clockwise operation and maximum functionality for flexible working on the construction site.	Small and powerful single-speed universal magnetic core drill with clockwise/anti-clockwise operation, permanent magnet and maximum functionality for very safe and flexible working on the construction site.	
PAGE	167	167	168	169	168	169	
Core drilling in metal with a Ø up to 35 mm	++	++	++	++	++	++	
Core drilling in metal with a Ø up to 50 mm							
Core drilling in metal with a Ø up to 65 mm							
Core drilling in metal with a Ø up to 110 mm							
Twist drills with drill chuck (DIN 338)	+	+	+	+	+	+	
Twist drills with MK fitting (DIN 345)	++	++					
Tapping	++	++	++	++	++	++	
Countersinking	++	++	++	++	++	++	
Reaming	++	++	++	++	++	++	
Working overhead	++	++	++	++	++	++	
Installation work	++	++	++	++	++	++	
Workshop jobs	++	++	++	++	++	++	
Electronic magnetic holding force							
Magnetic holding force display	•	•	•	•	•	•	
Reversible rotation	•	•	•	•	•	•	
Variable speed control	•	•	•	•	•	•	
Memory function	•	•	•	•	•	•	
Speed-controlled electronics (tacho)	•	•	•	•	•	•	
Torque slipping clutch							
Tilt sensor	•	•	•	•	•	•	
Input	W		1 100	1 010	1 100	1 010	
Output	W		550	550	550	550	
Battery voltage	V	18	18				
Speed, full load	rpm	130 - 520	130 - 520	130 - 520	130-520	130 - 520	130-520
Load speed in speed 1	rpm						
Load speed in speed 2	rpm						
Load speed in speed 3	rpm						
Load speed in speed 4	rpm						
Tool Holder		MT 2	MT 2				
Carbide core drill bit max. Ø	mm	35	35	35	35	35	35
HSS core drill max. Ø	mm	35	35	35	35	35	35
Core drill holder		QuickIN	3/4" Weldon	QuickIN	QuickIN	3/4" Weldon	3/4" Weldon
Stroke	mm	135	135	135	135	135	135
Total stroke range	mm	260	260	260	260	260	260
Adjustment range for drill jigs	mm						
Swivel range for drill jigs							
Magnetic holding power	N	9,000	9,000	10,000	9,000	10,000	9,000
Magnetic foot dimensions	mm	195 x 70	195 x 70	175 x 80	195 x 70	175 x 80	195 x 70
Weight according to EPTA	kg			10,6	12,5	10,6	12,5
Weight without storage battery	kg	12,1	12,1				

+ suitability ++ optimal suitability • included

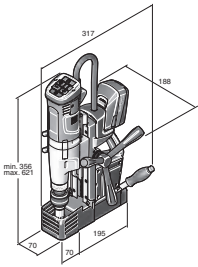

AKBU 35 PMQ
AKBU 35 PMQW

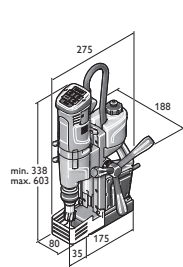

KBU 35 Q
KBU 35 QW

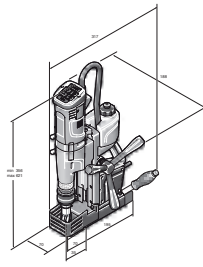

KBU 35 PQ
KBU 35 PQW

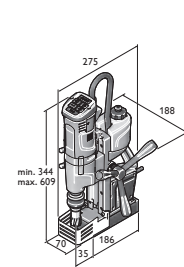

KBU 35-2 Q
KBU 35-2 QW

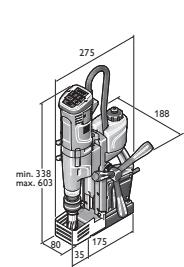

KBU 35 MQ
KBU 35 MQW

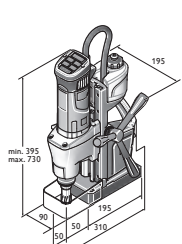

KBM 50 Q

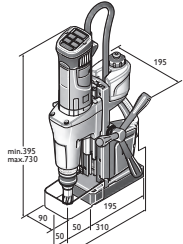

KBM 50 U

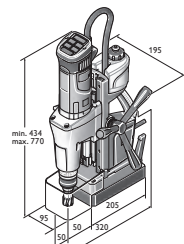

KBM 65 U

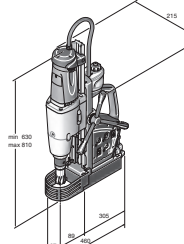

KBU 110-4 M

AKBU 35 PMQ SELECT**AKBU 35 PMQW SELECT**

Small and powerful single-speed cordless universal magnetic core drill with forward/reverse running, MT2 tool mounting, permanent magnet and maximum functionality for mobile working on the construction site.

Battery voltage	V	18	18
Battery compatibility		Li-ion/HighPower Li-ion**	Li-ion/HighPower Li-ion**
Battery interface		18 V	18 V
Motor		brushless	brushless
Speed, full load	rpm	130 - 520	130 - 520
Tool Holder		MT 2	MT 2
Carbide core drill bit max. Ø	mm	35	35
HSS core drill max. Ø	mm	35	35
Core drill, drilling depth max.	mm	50(75)*	50(75)*
Twist drill max. Ø	mm	18	18
Tapping		M 14	M 14
Countersinking max. Ø	mm	31	31
Reaming max. Ø	mm	18	18
Core drill holder		QuickIN	3/4" Weldon
Changing the core bit		tool-free	tool-free
Stroke	mm	135	135
Total stroke range	mm	260	260
Magnetic holding power	N	9,000	9,000
Magnetic foot dimensions	mm	195 x 70	195 x 70
Weight without storage battery	kg	12,1	12,1

FEIN BENEFITS

- + Extremely low-wear tool design with swivel-mounted motor cable protection hose for tough use in industry and manual trades.
 - + Small and light tool for continuously good work progress thanks to brushless FEIN PowerDrive motor with tachoelectronics and FEIN HighPower storage battery with cells with high current capability.
 - + Flexibility for all mobile drilling work, such as core drilling, twist drilling, tapping, countersinking and reaming.
 - + FEIN HighPower Li-ion battery. Continually high power output with 75 % higher current rating than a Li-ion battery for good work progress.
 - + Simple operating concept avoids mix-ups and can be clearly seen by the user.
 - + Convenient magnetic holding force display.
 - + Tilt sensor.
 - + Reversible.
 - + Electronic speed setting.
 - + Extra large stroke range.
 - + MT2 tool mounting.
 - + Extra narrow permanent magnet with magnetic bias.
 - + Speed saving "memory function".
 - + The battery charge can be read off the battery.
 - + FEIN SafetyCell technology. Protects the battery and tool from overload, overheating and total discharge.
- * Also available with accessories.
** Maximum performance with FEIN HighPower Li-ion battery.

SUPPLIED

1 x coolant pump, 1 lashing strap, 1 swarf hook, 1 centering pin, 1 contact guard, 1 drift key, 1 case

Part number	7 170 01 62 00 0	7 170 02 62 00 0
EAN	4014586889108	4014586889122

For accessories, see page 176

KBU 35 Q**KBU 35 QW**

Small and powerful single-speed universal magnetic core drill with clockwise/anti-clockwise operation and maximum functionality for flexible working on the construction site.

Input	W	1 100	1 100
Output	W	550	550
Speed, full load	rpm	130 - 520	130 - 520
Carbide core drill bit max. Ø	mm	35	35
HSS core drill max. Ø	mm	35	35
Core drill, drilling depth max.	mm	50	50
Twist drill max. Ø	mm	16	16
Tapping		M 14	M 14
Countersinking max. Ø	mm	31	31
Reaming max. Ø	mm	16	16
Core drill holder		QuickIN	3/4" Weldon
Changing the core bit		tool-free	tool-free
Stroke	mm	135	135
Total stroke range	mm	260	260
Magnetic holding power	N	10,000	10,000
Magnetic foot dimensions	mm	175 x 80	175 x 80
Cable with plug	m	4	4
Weight according to EPTA	kg	10,6	10,6

FEIN BENEFITS

- + Extremely low-wear tool design with swivel-mounted motor cable protection hose for tough use in industry and manual trades.
- + Perfect power-to-weight ratio thanks to compact, weight-optimised design and FEIN 1 100 W high-power motor with tacho electronics for high speed stability for reliable and economical working.
- + With clockwise/anti-clockwise operation, electronic speed setting and a 260 mm stroke range, this is a universal tool for core drilling, twist drilling, tapping, countersinking and reaming.
- + Small and lightweight.
- + Simple operating concept avoids mix-ups and can be clearly seen by the user.
- + Convenient magnetic holding force display.
- + High magnetic holding force.
- + Tilt sensor.
- + Additional magnetic switch in the drill jig.
- + Integrated coolant tank.
- + Feed handwheel can be moved from one side to the other.
- + Speed saving "memory function".
- + Personal safety switch.

SUPPLIED

1 coolant tank, 1 lashing strap, 1 swarf hook, 1 centering pin, 1 contact guard, 1 case

Part number	7 270 53 61 00 0	7 270 54 61 00 0
EAN	4014586886039	4014586886763

For accessories, see page 176

KBU 35 PQ**KBU 35 PQW**

Small and powerful single-speed universal magnetic core drill with clockwise/anti-clockwise operation, permanent magnet and maximum functionality for very safe and flexible working on the construction site.

Input	W	1 010	1 010
Output	W	550	550
Speed, full load	rpm	130-520	130-520
Carbide core drill bit max. Ø	mm	35	35
HSS core drill max. Ø	mm	35	35
Core drill, drilling depth max.	mm	50	50
Twist drill max. Ø	mm	16	16
Tapping		M 14	M 14
Countersinking max. Ø	mm	31	31
Reaming max. Ø	mm	16	16
Core drill holder		QuickIN	3/4" Weldon
Changing the core bit		tool-free	tool-free
Stroke	mm	135	135
Total stroke range	mm	260	260
Magnetic holding power	N	9,000	9,000
Magnetic foot dimensions	mm	195 x 70	195 x 70
Cable with plug	m	4	4
Weight according to EPTA	kg	12,5	12,5

FEIN BENEFITS

- + Permanent magnet for very safe working at height, swivel-mounted motor cable protective hose and good quality of workmanship for tough use.
- + Compact and lightweight tool with high torque for continuously good work progress thanks to FEIN high-power motor with tachometer electronics.
- + Tool with extra large stroke range for all drilling work, such as core, twist and tap drilling, countersinking and reaming.
- + Extra narrow permanent magnet with magnetic bias.
- + Tilt sensor.
- + Simple operating concept avoids mix-ups and can be clearly seen by the user.
- + Convenient magnetic holding force display.
- + Reversible.
- + Integrated coolant tank.
- + Speed saving "memory function".
- + Feed handwheel can be moved from one side to the other.
- + Personal safety switch.

SUPPLIED

1 coolant tank, 1 lashing strap, 1 swarf hook, 1 centring pin, diameter of 6.35 x 100 mm, 1 contact guard, 1 case

Part number	7 270 71 61 00 0	7 270 72 61 00 0
EAN	4014586890524	4014586890548

For accessories, see page 176

KBU 35-2 Q**KBU 35-2 QW**

Small and powerful 2-speed universal magnetic core drill with clockwise/anti-clockwise operation and high speed for efficient twist drilling on the construction site.

Input	W	1 100	1 100
Output	W	550	550
Load speed in speed 1	rpm	130 - 520	130 - 520
Load speed in speed 2	rpm	400 - 1,600	400 - 1,600
Carbide core drill bit max. Ø	mm	35	35
HSS core drill max. Ø	mm	35	35
Core drill, drilling depth max.	mm	50	50
Twist drill max. Ø	mm	16	16
Tapping		M 14	M 14
Countersinking max. Ø	mm	31	31
Reaming max. Ø	mm	16	16
Core drill holder		QuickIN	3/4" Weldon
Changing the core bit		tool-free	tool-free
Stroke	mm	135	135
Total stroke range	mm	260	260
Magnetic holding power	N	9,500	9,500
Magnetic foot dimensions	mm	186 x 70	186 x 70
Cable with plug	m	4	4
Weight according to EPTA	kg	11	11
FEIN BENEFITS		<ul style="list-style-type: none"> + Extremely low-wear tool design with swivel-mounted motor cable protection hose for tough use in industry and manual trades. + Perfect power-to-weight ratio thanks to compact, weight-optimised design and FEIN 1 100 W high-power motor with tacho electronics for high speed stability for reliable and economical working. + With clockwise/anti-clockwise operation, electronic speed setting and a 260 mm stroke range, this is a universal tool for core drilling, twist drilling, tapping, countersinking and reaming. + Small with mechanical 2-speed gearbox for twist drilling. + Simple operating concept avoids mix-ups and can be clearly seen by the user. + Convenient magnetic holding force display. + High magnetic holding force thanks to 3-coil magnet, just 70 mm wide. + Tilt sensor. + Additional magnetic switch in the drill jig. + Integrated coolant tank. + Feed handwheel can be moved from one side to the other. + Speed saving "memory function". + Personal safety switch. 	<ul style="list-style-type: none"> + Extremely resilient construction thanks to sturdy machine design with swivel-mounted motor cable protection hose. Designed for tough use in industry and manual trades.
SUPPLIED		1 coolant tank, 1 lashing strap, 1 swarf hook, 1 centering pin, 1 contact guard, 1 case	
Part number		7 270 57 61 00 0	7 270 58 61 00 0
EAN		4014586886077	4014586886787

For accessories, see page 176

KBU 35 MQ**KBU 35 MQW**

Small and powerful single-speed universal magnetic core drill with clockwise/anti-clockwise operation, MT2 tool mounting and maximum functionality for flexible working on the construction site.

Input	W	1 100	1 100
Output	W	550	550
Speed, full load	rpm	130 - 520	130 - 520
Tool Holder		MT 2	MT 2
Carbide core drill bit max. Ø	mm	35	35
HSS core drill max. Ø	mm	35	35
Core drill, drilling depth max.	mm	50(75)*	50(75)*
Twist drill max. Ø	mm	18	18
Tapping		M 14	M 14
Countersinking max. Ø	mm	31	31
Reaming max. Ø	mm	18	18
Core drill holder		QuickIN	3/4" Weldon
Changing the core bit		tool-free	tool-free
Stroke	mm	135	135
Total stroke range	mm	260	260
Magnetic holding power	N	10,000	10,000
Magnetic foot dimensions	mm	175 x 80	175 x 80
Cable with plug	m	4	4
Weight according to EPTA	kg	11	11

FEIN BENEFITS

- + Extremely low-wear tool design with swivel-mounted motor cable protection hose for tough use in industry and manual trades.
 - + Perfect power-to-weight ratio thanks to compact, weight-optimised design and FEIN 1 100 W high-power motor with tachometer for high speed stability for reliable and economical working.
 - + With clockwise/anti-clockwise operation, electronic speed setting and a 260 mm stroke range, this is a universal tool for core drilling, twist drilling, tapping, countersinking and reaming.
 - + Small with MT2 tool mounting.
 - + Simple operating concept avoids mix-ups and can be clearly seen by the user.
 - + Convenient magnetic holding force display.
 - + High magnetic holding force.
 - + Tilt sensor.
 - + Additional magnetic switch in the drill jig.
 - + Integrated coolant tank.
 - + Feed handwheel can be moved from one side to the other.
 - + Speed saving "memory function".
 - + Personal safety switch.
- * Also available with accessories.

SUPPLIED

1 coolant tank, 1 lashing strap, 1 swarf hook, 1 centering pin, 1 contact guard, 1 drift key, 1 case	1 coolant tank, 1 lashing strap, 1 swarf hook, 1 centering pin, 1 contact guard, 1 case
------------------------------------------------------------------------------------------------------	-----------------------------------------------------------------------------------------

Part number	7 270 55 61 00 0	7 270 56 61 00 0
EAN	4014586886053	4014586886770

For accessories, see page 176

KBM 50 Q**SUPPLIED**

1 coolant tank, 1 lashing strap,
1 swarf hook, 1 centering pin,
1 contact guard, 1 case

For accessories, see page 176

Lightweight and powerful 2-speed universal magnetic core drill with clockwise/anti-clockwise operation and maximum functionality for flexible working in the workshop and on the construction site.

Input	W	1 200
Output	W	640
Load speed in speed 1	rpm	130 - 260
Load speed in speed 2	rpm	260 - 520
Carbide core drill bit max. Ø	mm	50
HSS core drill max. Ø	mm	40
Core drill, drilling depth max.	mm	50
Twist drill max. Ø	mm	16
Tapping		M 16
Countersinking max. Ø	mm	31
Reaming max. Ø	mm	16
Core drill holder		QuickIN
Changing the core bit		tool-free
Stroke	mm	145
Total stroke range	mm	315
Magnetic holding power	N	12,500
Magnetic foot dimensions	mm	195 x 90
Cable with plug	m	4
Weight according to EPTA	kg	13,2

Part number	7 270 41 61 00 0
EAN	4014586872834

FEIN BENEFITS

- + Extremely low-wear tool design with swivel-mounted motor cable protection hose for tough use in industry and manual trades.
- + Perfect power-to-weight ratio thanks to compact, weight-optimised design and FEIN 1,200 W high-power motor with tach electronics for high speed stability for reliable and economical working.
- + With clockwise/anti-clockwise operation, electronic speed setting and a 315 mm stroke range, this is a universal tool for core drilling, twist drilling, tapping, countersinking and reaming.
- + Simple operating concept avoids mix-ups and can be clearly seen by the user.
- + Convenient magnetic holding force display.
- + High magnetic holding force.
- + Integrated coolant tank.
- + Feed handwheel can be moved from one side to the other.
- + Speed saving "memory function".
- + Personal safety switch.

KBM 50 U**SUPPLIED**

1 coolant tank, 1 lashing strap,
1 swarf hook, 1 centering pin,
1 contact guard, 1 drift key, 1 case

For accessories, see page 176

Lightweight and powerful 2-speed universal magnetic core drill with clockwise/anti-clockwise operation, MT3 tool mounting and maximum functionality for flexible working in the workshop and on the construction site.

Input	W	1 200
Output	W	610
Load speed in speed 1	rpm	130 - 260
Load speed in speed 2	rpm	260 - 520
Tool Holder		MK 3
Carbide core drill bit max. Ø	mm	50
HSS core drill max. Ø	mm	40
Core drill, drilling depth max.	mm	50(75)*
Twist drill max. Ø	mm	23
Tapping		M 16
Countersinking max. Ø	mm	50
Reaming max. Ø	mm	23
Core drill holder		QuickIN
Changing the core bit		tool-free
Stroke	mm	145
Total stroke range	mm	315
Magnetic holding power	N	12,500
Magnetic foot dimensions	mm	195 x 90
Cable with plug	m	4
Weight according to EPTA	kg	13,9

Part number	7 270 40 61 00 0
EAN	4014586872995

FEIN BENEFITS

- + Extremely low-wear tool design with swivel-mounted motor cable protection hose for tough use in industry and manual trades.
- + Perfect power-to-weight ratio thanks to compact, weight-optimised design and FEIN 1,200 W high-power motor with tach electronics for high speed stability for reliable and economical working.
- + With clockwise/anti-clockwise operation, electronic speed setting and a 315 mm stroke range, this is a universal tool for core drilling, twist drilling, tapping, countersinking and reaming.
- + MT3 tool mounting.
- + Simple operating concept avoids mix-ups and can be clearly seen by the user.
- + Convenient magnetic holding force display.
- + High magnetic holding force.
- + Integrated coolant tank.
- + Feed handwheel can be moved from one side to the other.
- + Speed saving "memory function".
- + Personal safety switch.
- * Also available with accessories.

KBM 65 U**SUPPLIED**

1 coolant tank, 1 lashing strap,
1 swarf hook, 1 centering pin,
1 contact guard, 1 drift key, 1 case

For accessories, see page 176

Powerful and very high-performance 2-speed universal magnetic core drill with clockwise/anti-clockwise operation, MT3 tool mounting, fine adjustment and maximum functionality for flexible working in the workshop.

Input	W	1 300
Output	W	730
Load speed in speed 1	rpm	120 - 240
Load speed in speed 2	rpm	260 - 520
Tool Holder		MK 3
Carbide core drill bit max. Ø	mm	65
HSS core drill max. Ø	mm	45
Core drill, drilling depth max.	mm	50(75)*
Twist drill max. Ø	mm	25
Tapping		M 20
Countersinking max. Ø	mm	50
Reaming max. Ø	mm	25
Core drill holder		QuickIN
Changing the core bit		tool-free
Stroke	mm	145
Total stroke range	mm	315
Adjustment range for drill jigs	mm	6
Swivel range for drill jigs		7°
Magnetic holding power	N	14,000
Magnetic foot dimensions	mm	205 x 95
Cable with plug	m	4
Weight according to EPTA	kg	16,1

FEIN BENEFITS

- + Extremely low-wear tool design with swivel-mounted motor cable protection hose for tough use in industry and manual trades.
- + Perfect power-to-weight ratio thanks to compact, weight-optimised design and FEIN 1,300 W high-power motor with tachometer electronics for high speed stability for reliable and economical working.
- + With clockwise/anti-clockwise operation, electronic speed setting and a 315 mm stroke range, this is a universal tool for core drilling, twist drilling, tapping, countersinking and reaming.
- + Fine adjustment of the drill spindle for convenient tool alignment.
- + MT3 tool mounting.
- + Simple operating concept avoids mix-ups and can be clearly seen by the user.
- + Convenient magnetic holding force display.
- + High magnetic holding force.
- + Integrated coolant tank.
- + Feed handwheel can be moved from one side to the other.
- + Speed saving "memory function".
- + Personal safety switch.
- * Also available with accessories.

Part number	7 270 43 61 00 0
EAN	4014586872902

KBU 110-4 M**SUPPLIED**

1 coolant tank, 1 safety strap with ratchet, 1 swarf hook, 2 centering pins, diameter of 6.35 x 125 mm and diameter of 7.98 x 184 mm, 1 contact guard, 1 drift key, 2 x 5 and 6 mm hexagon socket wrench, 1 additional handle, 1 case

For accessories, see page 176

High-performance and powerful 4-speed universal magnetic core drill with forward/reverse running, MT4 tool mounting and maximum functionality for the toughest drilling jobs in the workshop.

Input	W	1 700
Output	W	850
Load speed in speed 1	rpm	60 / 120
Load speed in speed 2	rpm	90 / 170
Load speed in speed 3	rpm	150 / 300
Load speed in speed 4	rpm	230 / 430
Idling speed in speed 1	rpm	100 / 190
Idling speed in speed 2	rpm	160 / 290
Idling speed in speed 3	rpm	270 / 500
Idling speed in speed 4	rpm	420 / 750
Tool Holder		MK 4
Carbide core drill bit max. Ø	mm	110
HSS core drill max. Ø	mm	80
Core drill, drilling depth max.	mm	100
Twist drill max. Ø	mm	40
Tapping		M 36
Countersinking max. Ø	mm	60
Reaming max. Ø	mm	36
Core drill holder		Weldon 32
Stroke	mm	280
Total stroke range	mm	400
Magnetic holding power	N	23,000
Magnetic foot dimensions	mm	240 x 120
Cable with plug	m	4
Weight according to EPTA	kg	39

FEIN BENEFITS

- + FEIN 1700 W high-power motor with high torque for heavy-duty drilling work.
- + For tough use thanks to outstanding quality of workmanship and swivel-mounted motor cable protective hose.
- + Tool with extra large stroke range for all drilling work, such as core, twist and tap drilling, countersinking and reaming.
- + Mechanical 4-speed gearbox.
- + High magnetic holding force.
- + Torque support for high stability.
- + Tilt sensor.
- + Slipping clutch torque.
- + Convenient magnetic holding force display.
- + Speed reduction.
- + Reversible.
- + MT4 tool mounting.
- + Integrated coolant tank.
- + Personal safety switch.

Part number	7 270 60 61 00 0
EAN	4014586889740

**KBM 50 AUTO**

Lightweight, powerful and ingenious 2-speed auto magnetic core drill offering maximum efficiency and minimum physical strain for core drilling in the workshop and on the construction site.

PAGE		175
Core drilling in metal with a Ø up to 35 mm		++
Core drilling in metal with a Ø up to 50 mm		++
Twist drills with drill chuck (DIN 338)		+
Twist drills with MK fitting (DIN 345)		++
Tapping		++
Countersinking		++
Reaming		++
Fully-automatic drilling		++
Working overhead		+
Installation work		++
Workshop jobs		++
Electronic magnetic holding force		•
Magnetic holding force display		•
Automatic drill feed		•
Reversible rotation		•
Variable speed control		•
Memory function		•
Speed-controlled electronics (tacho)		•
Tilt sensor		•
Input	W	1 200
Output	W	610
Load speed in speed 1	rpm	130 - 260 1/min
Load speed in speed 2	rpm	260 - 520 1/min
Tool Holder		MK 3
Carbide core drill bit max. Ø	mm	50
HSS core drill max. Ø	mm	40
Core drill, drilling depth max.	mm	50(75)*
Twist drill max. Ø	mm	18/23**
Tapping		M 16**
Countersinking max. Ø	mm	50**
Reaming max. Ø	mm	23**
Core drill holder		QuickIN
Stroke	mm	145
Total stroke range	mm	315
Magnetic holding power	N	12,500
Magnetic foot dimensions	mm	195 x 90
Cable with plug	m	4
Weight according to EPTA	kg	16,2

+ suitability ++ optimal suitability • included * Also available with accessories. ** In manual tool mode only

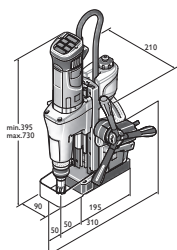

KBM 50 auto

KBM 50 AUTO**SUPPLIED**

1 coolant tank, 1 lashing strap,
1 swarf hook, 1 centering pin,
1 drift key, 1 contact guard, 1 case

For accessories, see page 176

Lightweight, powerful and ingenious 2-speed auto magnetic core drill offering maximum efficiency and minimum physical strain for core drilling in the workshop and on the construction site.

Input	W	1 200
Output	W	610
Load speed in speed 1	rpm	130 - 260 1/min
Load speed in speed 2	rpm	260 - 520 1/min
Tool Holder		MK 3
Carbide core drill bit max. Ø	mm	50
HSS core drill max. Ø	mm	40
Core drill, drilling depth max.	mm	50(75)*
Twist drill max. Ø	mm	18/23**
Tapping		M 16**
Countersinking max. Ø	mm	50**
Reaming max. Ø	mm	23**
Core drill holder		QuickIN
Changing the core bit		tool-free
Stroke	mm	145
Total stroke range	mm	315
Magnetic holding power	N	12,500
Magnetic foot dimensions	mm	195 x 90
Cable with plug	m	4
Weight according to EPTA	kg	16,2

FEIN BENEFITS

- + Extremely low-wear tool design with swivel-mounted motor cable protection hose for tough use in industry and manual trades.
- + Saves time and money when producing a large number of holes thanks to the digitally controlled drill feed.
- + With clockwise/anti-clockwise operation, electronic speed setting and a 315 mm stroke range, this is a universal tool for core drilling, twist drilling, tapping, countersinking and reaming.
- + Thanks to reproducible and timed drilling times, working hours for commissioned and serial work can be planned.
- + MT3 tool mounting.
- + FEIN high-power motor with stable speed.
- + Simple operating concept avoids mix-ups and can be clearly seen by the user.
- + High magnetic holding force.
- + Convenient magnetic holding force display.
- + Integrated coolant tank.
- + Tilt sensor.
- + Speed saving "memory function".
- + Personal safety switch.
- * Also available with accessories.
- ** In manual tool mode only

Part number	7 270 42 61 00 0
EAN	4014586874272

BEST OF CORE DRILLING CARBIDE ACCESSORY SET



BEST OF CORE BITS QUICKIN

Very long service life and outstanding cutting performance. Metric dimensions, cutting depth 35 mm. Set version, consisting of 6 core bits with diameters of 12, 14, 16, 18, 20 and 22 mm (cutting depth 35 mm) and 2 centring pins (100 mm) in plastic case.

Part number
6 31 27 086 04 0



BEST OF CORE BITS 3/4" WELDON

Very long service life and outstanding cutting performance. Metric dimensions, cutting depth 35 mm. Set version, consisting of 6 core bits with diameters of 12, 14, 16, 18, 20 and 22 mm (cutting depth 35 mm) and 2 centring pins (100 mm) in plastic case.

Part number
6 31 27 714 02 0



BEST OF CORE BITS 3/4" WELDON

Very long service life and outstanding cutting performance. Metric dimensions, cutting depth 50 mm. Set version, consisting of 6 core bits with diameters of 12, 14, 16, 18, 20 and 22 mm (cutting depth 50 mm) and 2 centring pins (100 mm) in plastic case.

Part number
6 31 27 276 02 0

CARBIDE CORE DRILL



TCT ULTRA 35 CORE BIT WITH QUICKIN HOLDER

Very long service life and outstanding cutting performance. Metric dimensions, cutting depth 35 mm.

Cutting depth mm	Bore Ø mm	Part number
35	12	6 31 27 086 01 9
35	13	6 31 27 087 01 3
35	14	6 31 27 088 01 1
35	15	6 31 27 089 01 5
35	15,5	6 31 27 238 01 1
35	16	6 31 27 090 01 7
35	17	6 31 27 091 01 6
35	17,5	6 31 27 239 01 5
35	18	6 31 27 092 01 9
35	19	6 31 27 093 01 3
35	19,5	6 31 27 240 01 7
35	20	6 31 27 094 01 1
35	21	6 31 27 095 01 5
35	22	6 31 27 096 01 8
35	23	6 31 27 097 01 2
35	24	6 31 27 098 01 0
35	25	6 31 27 099 01 4
35	26	6 31 27 100 01 5
35	26,5	6 31 27 241 01 6
35	27	6 31 27 101 01 4
35	28	6 31 27 102 01 7
35	29	6 31 27 103 01 1
35	30	6 31 27 104 01 9
35	31	6 31 27 105 01 3
35	32	6 31 27 106 01 6
35	33	6 31 27 107 01 0
35	34	6 31 27 108 01 8
35	35	6 31 27 109 01 2
35	36	6 31 27 110 01 4
35	37	6 31 27 111 01 3

Cutting depth mm	Bore Ø mm	Part number
35	38	6 31 27 112 01 6
35	39	6 31 27 113 01 0
35	40	6 31 27 114 01 8
35	41	6 31 27 115 01 2
35	42	6 31 27 116 01 5
35	43	6 31 27 117 01 9
35	44	6 31 27 118 01 7
35	45	6 31 27 119 01 1
35	46	6 31 27 120 01 3
35	47	6 31 27 121 01 2
35	48	6 31 27 122 01 5
35	49	6 31 27 123 01 9
35	50	6 31 27 124 01 7
35	51	6 31 27 125 01 1
35	52	6 31 27 126 01 4
35	53	6 31 27 127 01 8
35	54	6 31 27 128 01 6
35	55	6 31 27 129 01 0
35	56	6 31 27 130 01 2
35	57	6 31 27 131 01 1
35	58	6 31 27 132 01 4
35	59	6 31 27 133 01 8
35	60	6 31 27 134 01 6
35	61	6 31 27 135 01 0
35	62	6 31 27 136 01 3
35	63	6 31 27 137 01 7
35	64	6 31 27 138 01 5
35	65	6 31 27 139 01 9



TCT ULTRA 75 CORE BIT WITH QUICKIN HOLDER

Very long service life and outstanding cutting performance. Metric dimensions, cutting depth 75 mm.

Cutting depth mm	Bore Ø mm	Part number
75	18	6 31 27 763 01 0
75	19	6 31 27 764 01 0
75	20	6 31 27 765 01 0
75	21	6 31 27 766 01 0
75	22	6 31 27 767 01 0
75	23	6 31 27 768 01 0
75	24	6 31 27 769 01 0
75	25	6 31 27 770 01 0
75	26	6 31 27 771 01 0
75	27	6 31 27 772 01 0
75	28	6 31 27 773 01 0
75	29	6 31 27 774 01 0
75	30	6 31 27 775 01 0
75	32	6 31 27 776 01 0
75	35	6 31 27 777 01 0
75	36	6 31 27 778 01 0
75	40	6 31 27 779 01 0
75	45	6 31 27 780 01 0
75	50	6 31 27 781 01 0
75	55	6 31 27 782 01 0
75	60	6 31 27 783 01 0
75	65	6 31 27 784 01 0

**TCT ULTRA 50 CORE BIT WITH FEIN THREAD M 18 X 6 P 1.5**

Very long service life and outstanding cutting performance.
Metric dimensions, cutting depth 50 mm.

Cutting depth mm	Bore Ø mm	Part number
50	12	6 31 27 042 01 4
50	13	6 31 27 043 01 8
50	14	6 31 27 044 01 6
50	15	6 31 27 045 01 0
50	16	6 31 27 046 01 3
50	17	6 31 27 047 01 7
50	18	6 31 27 001 01 5
50	19	6 31 27 019 01 2
50	20	6 31 27 002 01 8
50	21	6 31 27 020 01 4
50	22	6 31 27 003 01 2
50	23	6 31 27 021 01 3
50	24	6 31 27 022 01 6
50	25	6 31 27 004 01 0
50	26	6 31 27 005 01 4
50	27	6 31 27 023 01 0
50	28	6 31 27 006 01 7
50	29	6 31 27 024 01 8
50	30	6 31 27 007 01 1
50	31	6 31 27 025 01 2
50	32	6 31 27 008 01 9
50	33	6 31 27 026 01 5
50	34	6 31 27 009 01 3
50	35	6 31 27 010 01 5
50	36	6 31 27 027 01 9
50	37	6 31 27 028 01 7
50	38	6 31 27 011 01 4
50	39	6 31 27 029 01 1
50	40	6 31 27 012 01 7
50	41	6 31 27 030 01 3
50	42	6 31 27 013 01 1
50	43	6 31 27 014 01 9
50	44	6 31 27 031 01 2
50	45	6 31 27 015 01 3
50	46	6 31 27 032 01 5
50	47	6 31 27 033 01 9
50	48	6 31 27 016 01 6
50	49	6 31 27 034 01 7
50	50	6 31 27 017 01 0
50	51	6 31 27 035 01 1
50	52	6 31 27 018 01 8
50	53	6 31 27 036 01 4
50	54	6 31 27 037 01 8
50	55	6 31 27 038 01 6
50	56	6 31 27 039 01 0
50	57	6 31 27 040 01 2
50	58	6 31 27 041 01 1
50	59	6 31 27 049 01 9
50	60	6 31 27 050 01 1
50	61	6 31 27 051 01 0
50	62	6 31 27 052 01 3
50	63	6 31 27 053 01 7
50	64	6 31 27 054 01 5
50	65	6 31 27 055 01 9

**TCT ULTRA 35 CORE BIT WITH 3/4" WELDON HOLDER**

Very long service life and outstanding cutting performance.
Metric dimensions, cutting depth 35 mm.

Cutting depth mm	Bore Ø mm	Part number
35	12	6 31 27 714 01 0
35	13	6 31 27 715 01 0
35	14	6 31 27 716 01 0
35	15	6 31 27 717 01 0
35	16	6 31 27 718 01 0
35	17	6 31 27 719 01 0
35	18	6 31 27 720 01 0
35	19	6 31 27 721 01 0
35	20	6 31 27 722 01 0
35	21	6 31 27 723 01 0
35	22	6 31 27 724 01 0
35	23	6 31 27 725 01 0
35	24	6 31 27 726 01 0
35	25	6 31 27 727 01 0
35	26	6 31 27 728 01 0
35	27	6 31 27 729 01 0
35	28	6 31 27 730 01 0
35	29	6 31 27 731 01 0
35	30	6 31 27 732 01 0
35	31	6 31 27 733 01 0
35	32	6 31 27 734 01 0
35	33	6 31 27 735 01 0
35	34	6 31 27 736 01 0
35	35	6 31 27 737 01 0
35	36	6 31 27 738 01 0
35	37	6 31 27 739 01 0
35	38	6 31 27 740 01 0
35	39	6 31 27 741 01 0
35	40	6 31 27 742 01 0
35	41	6 31 27 743 01 0
35	42	6 31 27 744 01 0
35	43	6 31 27 745 01 0
35	44	6 31 27 746 01 0
35	45	6 31 27 747 01 0
35	46	6 31 27 748 01 0
35	47	6 31 27 749 01 0
35	48	6 31 27 750 01 0
35	49	6 31 27 751 01 0
35	50	6 31 27 752 01 0
35	51	6 31 27 753 01 0
35	52	6 31 27 754 01 0
35	53	6 31 27 755 01 0
35	54	6 31 27 756 01 0
35	55	6 31 27 757 01 0
35	56	6 31 27 758 01 0
35	57	6 31 27 759 01 0
35	58	6 31 27 760 01 0
35	59	6 31 27 761 01 0
35	60	6 31 27 762 01 0

**TCT ULTRA 50 CORE BIT WITH 3/4" WELDON HOLDER**

Very long service life and outstanding cutting performance.
Metric dimensions, cutting depth 50 mm.

Cutting depth mm	Bore Ø mm	Part number
50	12	6 31 27 276 01 0
50	13	6 31 27 277 01 0
50	14	6 31 27 278 01 0
50	15	6 31 27 279 01 0
50	15,5	6 31 27 828 01 0
50	16	6 31 27 280 01 0
50	17	6 31 27 281 01 0
50	17,5	6 31 27 829 01 0
50	18	6 31 27 282 01 0
50	19	6 31 27 283 01 0
50	19,5	6 31 27 830 01 0
50	20	6 31 27 284 01 0
50	21	6 31 27 285 01 0
50	22	6 31 27 286 01 0
50	23	6 31 27 287 01 0
50	24	6 31 27 288 01 0
50	25	6 31 27 289 01 0
50	26	6 31 27 290 01 0
50	26,5	6 31 27 831 01 0
50	27	6 31 27 291 01 0
50	28	6 31 27 292 01 0
50	29	6 31 27 293 01 0
50	30	6 31 27 294 01 0
50	31	6 31 27 295 01 0
50	32	6 31 27 296 01 0
50	33	6 31 27 297 01 0
50	34	6 31 27 298 01 0
50	35	6 31 27 299 01 0
50	36	6 31 27 300 01 0
50	37	6 31 27 301 01 0
50	38	6 31 27 302 01 0
50	39	6 31 27 303 01 0
50	40	6 31 27 304 01 0
50	41	6 31 27 305 01 0
50	42	6 31 27 306 01 0
50	43	6 31 27 307 01 0
50	44	6 31 27 308 01 0
50	45	6 31 27 309 01 0
50	46	6 31 27 310 01 0
50	47	6 31 27 311 01 0
50	48	6 31 27 312 01 0
50	49	6 31 27 313 01 0
50	50	6 31 27 314 01 0
50	51	6 31 27 315 01 0
50	52	6 31 27 316 01 0
50	53	6 31 27 317 01 0
50	54	6 31 27 318 01 0
50	55	6 31 27 319 01 0
50	56	6 31 27 320 01 0
50	57	6 31 27 321 01 0
50	58	6 31 27 322 01 0
50	59	6 31 27 323 01 0
50	60	6 31 27 324 01 0
50	61	6 31 27 325 01 0
50	62	6 31 27 326 01 0
50	63	6 31 27 327 01 0
50	64	6 31 27 328 01 0
50	65	6 31 27 329 01 0

**TCT ULTRA 75 CORE BIT WITH 3/4" WELDON HOLDER**

Very long service life and outstanding cutting performance.
Metric dimensions, cutting depth 75 mm.

Cutting depth mm	Bore Ø mm	Part number
75	18	6 31 27 785 01 0
75	19	6 31 27 786 01 0
75	20	6 31 27 787 01 0
75	21	6 31 27 788 01 0
75	22	6 31 27 789 01 0
75	23	6 31 27 790 01 0
75	24	6 31 27 791 01 0
75	25	6 31 27 792 01 0
75	26	6 31 27 793 01 0
75	27	6 31 27 794 01 0
75	28	6 31 27 795 01 0
75	29	6 31 27 796 01 0
75	30	6 31 27 797 01 0
75	32	6 31 27 798 01 0
75	35	6 31 27 799 01 0
75	36	6 31 27 800 01 0
75	40	6 31 27 801 01 0
75	45	6 31 27 802 01 0
75	50	6 31 27 803 01 0
75	55	6 31 27 804 01 0
75	60	6 31 27 805 01 0
75	65	6 31 27 806 01 0

**HM ULTRA 50 CORE DRILL BIT WITH QUICKIN MAX/
WELDON 32 FITTING**

Very long service life and outstanding cutting performance.
Metric dimensions, cutting depth 50 mm.

Cutting depth mm	Bore Ø mm	Part number
50	50	6 31 27 330 01 0
50	51	6 31 27 331 01 0
50	52	6 31 27 332 01 0
50	53	6 31 27 333 01 0
50	54	6 31 27 334 01 0
50	55	6 31 27 335 01 0
50	56	6 31 27 336 01 0
50	57	6 31 27 337 01 0
50	58	6 31 27 338 01 0
50	59	6 31 27 339 01 0
50	60	6 31 27 340 01 0
50	61	6 31 27 341 01 0
50	62	6 31 27 342 01 0
50	63	6 31 27 343 01 0
50	64	6 31 27 344 01 0
50	65	6 31 27 345 01 0
50	66	6 31 27 346 01 0
50	67	6 31 27 347 01 0
50	68	6 31 27 348 01 0
50	69	6 31 27 349 01 0
50	70	6 31 27 350 01 0
50	71	6 31 27 351 01 0
50	72	6 31 27 352 01 0
50	73	6 31 27 353 01 0
50	74	6 31 27 354 01 0
50	75	6 31 27 355 01 0
50	76	6 31 27 456 01 0
50	77	6 31 27 457 01 0
50	78	6 31 27 458 01 0
50	79	6 31 27 459 01 0
50	80	6 31 27 460 01 0
50	85	6 31 27 807 01 0
50	90	6 31 27 808 01 0
50	95	6 31 27 809 01 0
50	100	6 31 27 810 01 0
50	105	6 31 27 822 01 0
50	110	6 31 27 823 01 0



HM ULTRA 100 CORE DRILL BIT WITH WELDON 32 FITTING

Very long service life and outstanding cutting performance. Metric dimensions, cutting depth 100 mm. Internal hole 8 mm.

Cutting depth mm	Bore Ø mm	Part number
100	50	6 31 27 811 01 0
100	55	6 31 27 812 01 0
100	60	6 31 27 813 01 0
100	65	6 31 27 814 01 0
100	70	6 31 27 815 01 0
100	74	6 31 27 826 01 0
100	75	6 31 27 816 01 0
100	80	6 31 27 817 01 0
100	82	6 31 27 827 01 0
100	85	6 31 27 818 01 0
100	90	6 31 27 819 01 0
100	95	6 31 27 820 01 0
100	100	6 31 27 821 01 0
100	105	6 31 27 824 01 0
100	110	6 31 27 825 01 0

BEST OF CORE DRILLING HSS ACCESSORY SET



BEST OF CORE BITS QUICKIN

Industrial standard. Metric dimensions, cutting depth 50 mm. Set version, consisting of 6 core bits with diameters of 12, 14, 16, 18, 20 and 22 mm (cutting depth 50 mm) and 2 centring pins (100 mm) in plastic case.

Part number
6 31 33 999 01 0



BEST OF CORE BITS 3/4" WELDON

Industrial standard. Metric dimensions, cutting depth 25 mm. Set version, consisting of 6 core bits with diameters of 12, 14, 16, 18, 20 and 22 mm (cutting depth 25 mm) and 2 centring pins (80 mm) in plastic case.

Part number
6 31 34 999 06 1



BEST OF CORE BITS 3/4" WELDON

Industrial standard. Metric dimensions, cutting depth 25 mm. Set version, consisting of 4 core bits, 2 x 14 mm diameter, 2 x 18 mm diameter, (cutting depth 25 mm) and 1 centring pin (80 mm) in plastic case.

Part number
6 31 34 999 06 2



BEST OF CORE BITS 3/4" WELDON

Industrial standard. Metric dimensions, cutting depth 50 mm. Set version, consisting of 6 core bits with diameters of 12, 14, 16, 18, 20 and 22 mm (cutting depth 50 mm) and 2 centring pins (100 mm) in plastic case.

Part number
6 31 34 999 06 3



BEST OF CORE BITS 3/4" WELDON

Industrial standard. Metric dimensions, cutting depth 50 mm. Set version, consisting of 4 core bits, 2x 14 mm diameter, 2x 18 mm diameter, (cutting depth 50 mm) and 1 centring pin (100 mm) in plastic case.

Part number
6 31 34 999 06 4

HSS CORE DRILL



HSS NOVA 25 CORE BIT WITH QUICKIN HOLDER

Industrial standard. Metric dimensions, cutting depth 25 mm.

Cutting depth mm	Bore Ø mm	Part number
25	12	6 31 33 119 05 1
25	13	6 31 33 129 05 1
25	14	6 31 33 140 05 1
25	15	6 31 33 150 05 1
25	16	6 31 33 159 05 1
25	17	6 31 33 170 05 1
25	18	6 31 33 180 05 1
25	19	6 31 33 189 05 1
25	20	6 31 33 199 06 3
25	21	6 31 33 210 05 1
25	22	6 31 33 219 05 1
25	23	6 31 33 229 05 1
25	24	6 31 33 240 05 1
25	25	6 31 33 250 05 1
25	26	6 31 33 259 05 1
25	27	6 31 33 270 05 1
25	28	6 31 33 279 05 1
25	29	6 31 33 289 05 1
25	30	6 31 33 299 05 1
25	31	6 31 33 309 05 1
25	32	6 31 33 319 05 1
25	33	6 31 33 329 05 1
25	34	6 31 33 339 05 1
25	35	6 31 33 350 05 1
25	36	6 31 33 359 05 1
25	37	6 31 33 369 05 1
25	38	6 31 33 379 05 1
25	39	6 31 33 389 05 1
25	40	6 31 33 399 05 1
25	41	6 31 33 409 05 1
25	42	6 31 33 420 05 1
25	43	6 31 33 429 05 1
25	44	6 31 33 439 05 1
25	45	6 31 33 449 05 1
25	46	6 31 33 459 05 1
25	47	6 31 33 469 05 1
25	48	6 31 33 479 05 1
25	49	6 31 33 489 05 1
25	50	6 31 33 499 05 1



HSS NOVA 50 CORE BIT WITH QUICKIN HOLDER

Industrial standard. Metric dimensions, cutting depth 50 mm.

Cutting depth mm	Bore Ø mm	Part number
50	12	6 31 33 119 05 2
50	13	6 31 33 129 05 2
50	14	6 31 33 140 05 2
50	15	6 31 33 150 05 2
50	16	6 31 33 159 05 2
50	17	6 31 33 170 05 2
50	18	6 31 33 180 05 2
50	19	6 31 33 189 05 2
50	20	6 31 33 199 05 2
50	21	6 31 33 210 05 2
50	22	6 31 33 219 05 2
50	23	6 31 33 229 05 2
50	24	6 31 33 240 05 2
50	25	6 31 33 250 05 2

Cutting depth mm	Bore Ø mm	Part number
50	26	6 31 33 259 05 2
50	27	6 31 33 270 05 2
50	28	6 31 33 279 05 2
50	29	6 31 33 289 05 2
50	30	6 31 33 299 05 2
50	31	6 31 33 309 05 2
50	32	6 31 33 319 05 2
50	33	6 31 33 329 05 2
50	34	6 31 33 339 05 2
50	35	6 31 33 350 05 2
50	36	6 31 33 359 05 2
50	37	6 31 33 369 05 2
50	38	6 31 33 379 05 2
50	39	6 31 33 389 05 2
50	40	6 31 33 399 05 2
50	41	6 31 33 409 05 2
50	42	6 31 33 420 05 2
50	43	6 31 33 429 05 2
50	44	6 31 33 439 05 2
50	45	6 31 33 449 05 2
50	46	6 31 33 459 05 2
50	47	6 31 33 469 05 2
50	48	6 31 33 479 05 2
50	49	6 31 33 489 05 2
50	50	6 31 33 499 05 2



HSS NOVA 25 CORE BIT WITH 3/4" WELDON HOLDER
Industrial standard. Metric dimensions, cutting depth 25 mm.

Cutting depth mm	Bore Ø mm	Part number
25	12	6 31 34 120 05 1
25	13	6 31 34 130 05 1
25	14	6 31 34 140 05 1
25	15	6 31 34 150 05 1
25	16	6 31 34 160 05 1
25	17	6 31 34 170 05 1
25	18	6 31 34 180 05 1
25	19	6 31 34 190 05 1
25	20	6 31 34 200 05 1
25	21	6 31 34 210 05 1
25	22	6 31 34 220 05 1
25	23	6 31 34 230 05 1
25	24	6 31 34 240 05 1
25	25	6 31 34 250 05 1
25	26	6 31 34 260 05 1
25	27	6 31 34 270 05 1
25	28	6 31 34 280 05 1
25	29	6 31 34 290 05 1
25	30	6 31 34 300 05 1
25	31	6 31 34 310 05 1
25	32	6 31 34 320 05 1
25	33	6 31 34 330 05 1
25	34	6 31 34 340 05 1
25	35	6 31 34 350 05 1
25	36	6 31 34 360 05 1
25	37	6 31 34 370 05 1
25	38	6 31 34 380 05 1
25	39	6 31 34 390 05 1
25	40	6 31 34 400 05 1
25	41	6 31 34 410 05 1
25	42	6 31 34 420 05 1
25	43	6 31 34 430 05 1

Cutting depth mm	Bore Ø mm	Part number
25	44	6 31 34 440 05 1
25	45	6 31 34 450 05 1
25	46	6 31 34 460 05 1
25	47	6 31 34 470 05 1
25	48	6 31 34 480 05 1
25	49	6 31 34 490 05 1
25	50	6 31 34 500 05 1
25	51	6 31 34 510 05 1
25	52	6 31 34 520 05 1
25	53	6 31 34 530 05 1
25	54	6 31 34 540 05 1
25	55	6 31 34 550 05 1
25	56	6 31 34 560 05 1
25	57	6 31 34 570 05 1
25	58	6 31 34 580 05 1
25	59	6 31 34 590 05 1
25	60	6 31 34 600 05 1



HSS NOVA 50 CORE BIT WITH 3/4" WELDON HOLDER
Industrial standard. Metric dimensions, cutting depth 50 mm.

Cutting depth mm	Bore Ø mm	Part number
50	12	6 31 34 120 05 2
50	13	6 31 34 130 05 2
50	14	6 31 34 140 05 2
50	15	6 31 34 150 05 2
50	16	6 31 34 160 05 2
50	17	6 31 34 170 05 2
50	18	6 31 34 180 05 2
50	19	6 31 34 190 05 2
50	20	6 31 34 200 05 2
50	21	6 31 34 210 05 2
50	22	6 31 34 220 05 2
50	23	6 31 34 230 05 2
50	24	6 31 34 240 05 2
50	25	6 31 34 250 05 2
50	26	6 31 34 260 05 2
50	27	6 31 34 270 05 2
50	28	6 31 34 280 05 2
50	29	6 31 34 290 05 2
50	30	6 31 34 300 05 2
50	31	6 31 34 310 05 2
50	32	6 31 34 320 05 2
50	33	6 31 34 330 05 2
50	34	6 31 34 340 05 2
50	35	6 31 34 350 05 2
50	36	6 31 34 360 05 2
50	37	6 31 34 370 05 2
50	38	6 31 34 380 05 2
50	39	6 31 34 390 05 2
50	40	6 31 34 400 05 2
50	41	6 31 34 410 05 2
50	42	6 31 34 420 05 2
50	43	6 31 34 430 05 2
50	44	6 31 34 440 05 2
50	45	6 31 34 450 05 2
50	46	6 31 34 460 05 2
50	47	6 31 34 470 05 2
50	48	6 31 34 480 05 2
50	49	6 31 34 490 05 2
50	50	6 31 34 500 05 2
50	51	6 31 34 510 05 2

Cutting depth mm	Bore Ø mm	Part number
50	52	6 31 34 520 05 2
50	53	6 31 34 530 05 2
50	54	6 31 34 540 05 2
50	55	6 31 34 550 05 2
50	56	6 31 34 560 05 2
50	57	6 31 34 570 05 2
50	58	6 31 34 580 05 2
50	59	6 31 34 590 05 2
50	60	6 31 34 600 05 2



HSS NOVA 75 CORE BIT WITH 3/4" WELDON HOLDER
Industrial standard. Metric dimensions, cutting depth 75 mm.

Cutting depth mm	Bore Ø mm	Part number
75	19	6 31 34 190 05 3
75	20	6 31 34 200 05 3
75	21	6 31 34 210 05 3
75	22	6 31 34 220 05 3
75	23	6 31 34 230 05 3
75	24	6 31 34 240 05 3
75	25	6 31 34 250 05 3
75	26	6 31 34 260 05 3
75	27	6 31 34 270 05 3
75	28	6 31 34 280 05 3
75	29	6 31 34 290 05 3
75	30	6 31 34 300 05 3
75	32	6 31 34 320 05 3
75	35	6 31 34 350 05 3
75	36	6 31 34 360 05 3
75	40	6 31 34 400 05 3
75	45	6 31 34 450 05 3
75	50	6 31 34 500 05 3
75	60	6 31 34 600 05 3



HSS SPECIAL 25 CORE BIT WITH 3/4" WELDON FITTING
Long service life. For drilling multi-layered materials in a single process.

Cutting depth mm	Bore Ø mm	Part number
25	12	6 31 34 120 30 1
25	13	6 31 34 130 30 1
25	14	6 31 34 140 30 1
25	14,3	6 31 34 143 30 1
25	15	6 31 34 150 30 1
25	16	6 31 34 160 30 1
25	17	6 31 34 170 30 1
25	18	6 31 34 180 30 1
25	20	6 31 34 200 30 1
25	22	6 31 34 220 30 1
25	24	6 31 34 240 30 1
25	26	6 31 34 260 30 1
25	28	6 31 34 280 30 1
25	30	6 31 34 300 30 1
25	32	6 31 34 320 30 1
25	35	6 31 34 350 30 1



HSS DURA 25 CORE BIT WITH QUICKIN HOLDER

TiN surface coating for outstanding service lives and the best glide properties.
Metric dimensions, cutting depth 25 mm.

Cutting depth mm	Bore Ø mm	Part number
25	12	6 31 33 120 06 7
25	13	6 31 33 130 06 7
25	14	6 31 33 140 06 7
25	15	6 31 33 150 06 7
25	16	6 31 33 160 06 7
25	17	6 31 33 170 06 7
25	18	6 31 33 180 06 7
25	19	6 31 33 190 06 7
25	20	6 31 33 200 06 7
25	21	6 31 33 210 06 7
25	22	6 31 33 220 06 7
25	23	6 31 33 230 06 7
25	24	6 31 33 240 06 7
25	25	6 31 33 250 06 7
25	26	6 31 33 260 06 7
25	27	6 31 33 270 06 7
25	28	6 31 33 280 06 7
25	29	6 31 33 290 06 7
25	30	6 31 33 300 06 7
25	31	6 31 33 310 06 7
25	32	6 31 33 320 06 7
25	34	6 31 33 340 06 7
25	37	6 31 33 370 06 7
25	43	6 31 33 430 06 7
25	44	6 31 33 440 06 7
25	45	6 31 33 450 06 7
25	46	6 31 33 460 06 7
25	47	6 31 33 470 06 7
25	48	6 31 33 480 06 7
25	49	6 31 33 490 06 7
25	50	6 31 33 500 06 7



HSS DURA 50 CORE BIT WITH QUICKIN HOLDER

TiN surface coating for outstanding service lives and the best glide properties.
Metric dimensions, cutting depth 50 mm.

Cutting depth mm	Bore Ø mm	Part number
50	12	6 31 33 120 06 8
50	13	6 31 33 130 06 8
50	14	6 31 33 140 06 8
50	15	6 31 33 150 06 8
50	16	6 31 33 160 06 8
50	17	6 31 33 170 06 8
50	18	6 31 33 180 06 8
50	19	6 31 33 190 06 8
50	20	6 31 33 200 06 8
50	21	6 31 33 210 06 8
50	22	6 31 33 220 06 8
50	23	6 31 33 230 06 8
50	24	6 31 33 240 06 8
50	25	6 31 33 250 06 8
50	26	6 31 33 260 06 8
50	27	6 31 33 270 06 8
50	28	6 31 33 280 06 8
50	29	6 31 33 290 06 8
50	30	6 31 33 300 06 8
50	31	6 31 33 310 06 8
50	32	6 31 33 320 06 8
50	33	6 31 33 330 06 8
50	34	6 31 33 340 06 8
50	35	6 31 33 350 06 8
50	36	6 31 33 360 06 8

Cutting depth mm	Bore Ø mm	Part number
50	37	6 31 33 370 06 8
50	38	6 31 33 380 06 8
50	39	6 31 33 390 06 8
50	40	6 31 33 400 06 8
50	41	6 31 33 410 06 8
50	42	6 31 33 420 06 8
50	43	6 31 33 430 06 8
50	44	6 31 33 440 06 8
50	45	6 31 33 450 06 8
50	46	6 31 33 460 06 8
50	47	6 31 33 470 06 8
50	48	6 31 33 480 06 8
50	49	6 31 33 490 06 8
50	50	6 31 33 500 06 8



HSS DURA 25 CORE BIT WITH 3/4" WELDON HOLDER
TiN surface coating for outstanding service lives and the best glide properties.
Metric dimensions, cutting depth 25 mm.

Cutting depth mm	Bore Ø mm	Part number
25	12	6 31 34 120 07 5
25	13	6 31 34 130 07 5
25	14	6 31 34 140 07 5
25	15	6 31 34 150 07 5
25	16	6 31 34 160 07 5
25	17	6 31 34 170 07 5
25	18	6 31 34 180 07 5
25	19	6 31 34 190 07 5
25	20	6 31 34 200 07 5
25	21	6 31 34 210 07 5
25	22	6 31 34 220 07 5
25	23	6 31 34 230 07 5
25	24	6 31 34 240 07 5
25	25	6 31 34 250 07 5
25	26	6 31 34 260 07 5
25	27	6 31 34 270 07 5
25	28	6 31 34 280 07 5
25	29	6 31 34 290 07 5
25	30	6 31 34 300 07 5
25	31	6 31 34 310 07 5
25	32	6 31 34 320 07 5
25	33	6 31 34 330 07 5
25	34	6 31 34 340 07 5
25	35	6 31 34 350 07 5
25	36	6 31 34 360 07 5
25	37	6 31 34 370 07 5
25	38	6 31 34 380 07 5
25	39	6 31 34 390 07 5
25	40	6 31 34 400 07 5
25	41	6 31 34 410 07 5
25	42	6 31 34 420 07 5
25	43	6 31 34 430 07 5
25	44	6 31 34 440 07 5
25	45	6 31 34 450 07 5
25	46	6 31 34 460 07 5
25	47	6 31 34 470 07 5
25	48	6 31 34 480 07 5
25	49	6 31 34 490 07 5
25	50	6 31 34 500 07 5
25	51	6 31 34 510 07 5
25	52	6 31 34 520 07 5
25	53	6 31 34 530 07 5
25	54	6 31 34 540 07 5

Cutting depth mm	Bore Ø mm	Part number
25	55	6 31 34 550 07 5
25	56	6 31 34 560 07 5
25	57	6 31 34 570 07 5
25	58	6 31 34 580 07 5
25	59	6 31 34 590 07 5
25	60	6 31 34 600 07 5



HSS DURA 50 CORE BIT WITH 3/4" WELDON HOLDER
TiN surface coating for outstanding service lives and the best glide properties.
Metric dimensions, cutting depth 50 mm.

Cutting depth mm	Bore Ø mm	Part number
50	12	6 31 34 120 07 6
50	13	6 31 34 130 07 6
50	14	6 31 34 140 07 6
50	15	6 31 34 150 07 6
50	16	6 31 34 160 07 6
50	17	6 31 34 170 07 6
50	18	6 31 34 180 07 6
50	19	6 31 34 190 07 6
50	20	6 31 34 200 07 6
50	21	6 31 34 210 07 6
50	22	6 31 34 220 07 6
50	23	6 31 34 230 07 6
50	24	6 31 34 240 07 6
50	25	6 31 34 250 07 6
50	26	6 31 34 260 07 6
50	27	6 31 34 270 07 6
50	28	6 31 34 280 07 6
50	29	6 31 34 290 07 6
50	30	6 31 34 300 07 6
50	31	6 31 34 310 07 6
50	32	6 31 34 320 07 6
50	33	6 31 34 330 07 6
50	34	6 31 34 340 07 6
50	35	6 31 34 350 07 6
50	36	6 31 34 360 07 6
50	37	6 31 34 370 07 6
50	38	6 31 34 380 07 6
50	39	6 31 34 390 07 6
50	40	6 31 34 400 07 6
50	41	6 31 34 410 07 6
50	42	6 31 34 420 07 6
50	43	6 31 34 430 07 6
50	44	6 31 34 440 07 6
50	45	6 31 34 450 07 6
50	46	6 31 34 460 07 6
50	47	6 31 34 470 07 6
50	48	6 31 34 480 07 6
50	49	6 31 34 490 07 6
50	50	6 31 34 500 07 6
50	51	6 31 34 510 07 6
50	52	6 31 34 520 07 6
50	53	6 31 34 530 07 6
50	54	6 31 34 540 07 6
50	55	6 31 34 550 07 6
50	56	6 31 34 560 07 6
50	57	6 31 34 570 07 6
50	58	6 31 34 580 07 6
50	59	6 31 34 590 07 6
50	60	6 31 34 600 07 6

CENTERING PINS

 **CENTERING PIN**

Ø mm	L mm	Part number
6,35	82	6 31 34 998 30 0
6,35	100	6 31 34 998 31 0
6,35	125	6 31 34 998 33 0
6,35	135	6 31 34 998 33 5

 **CENTERING PIN**
2 parts.

Ø mm	L mm	Part number
7,98	184	3 02 17 362 01 0

ADAPTER/DRILL CHUCK



QUICKIN-ADAPTOR
Output M18 x 6 P 1.5

Part number
6 39 01 020 00 6



QUICKIN-ADAPTOR
Output 3/4" Weldon

Part number
6 39 01 021 01 4



QUICKIN-ADAPTOR
Special Weldon output. Specially designed for core bits from other manufacturers that have an internal hole of > 6.4 mm.

Part number
6 39 01 024 01 9



QUICKIN-ADAPTOR
Output 1/2" - 20 UNF

Part number
6 39 01 022 00 8



QUICKIN-ADAPTOR
Output B 16

Part number
6 39 01 023 00 2



ADAPTER WITH 3/4" WELDON FITTING
for converting competitor products to the QuickIN system.

Part number
6 39 01 027 01 0



ADAPTER WITH 3/4" WELDON FITTING
Output B 16

Part number
6 39 01 061 00 0



ADAPTER WITH 3/4" WELDON FITTING
Output 1/2" - 20 UNF

Part number
6 39 01 070 00 0



ADAPTER WITH QUICKIN MAX / WELDON 32 FITTING
QuickIN output

Part number
6 39 01 045 01 0



ADAPTER WITH QUICKIN MAX / WELDON 32 FITTING
Output 3/4" Weldon

Part number
6 39 01 076 01 0



ADAPTER WITH WELDON 32 FITTING
Output 3/4" Weldon

Part number
6 39 01 075 01 0



EXTENSION
for use on confined, deep, or layered surfaces, through holes possible as of Ø 36 mm. QuickIN fitting, length 100 mm, including centring pin.

Part number
6 31 06 016 01 0



EXTENSION
For use on confined, deep, or layered surfaces, through holes possible from a diameter of 34 mm. 3/4" Weldon fitting, length 100 mm.

Length mm	Part number
100	6 31 06 022 98 0



KEY-TYPE DRILL CHUCK WITH QUICKIN HOLDER

Chuck opening mm	Part number
1,5 - 13	6 39 01 023 02 0
3 - 16	6 39 01 023 01 1



KEY-TYPE DRILL CHUCK WITH 3/4" WELDON FITTING

Chuck opening mm	Part number
1,5 - 13	6 39 01 061 02 0



MORSE TAPER ARBORS
For tools with Morse taper.

Mount	Part number
MT 4/B 22	6 33 01 016 00 4



REDUCING SLEEVES
for M.T. sockets

Mount	Part number
MT 4/MT 3	6 33 02 004 00 2



HSS SPIRAL DRILL WITH QUICKIN FITTING
Cutting depth 35 mm

Bore Ø mm	Part number
10	6 31 11 009 01 0
10,2	6 31 11 010 01 0
11	6 31 11 011 01 0
12	6 31 11 012 01 0
13	6 31 11 013 01 0
14	6 31 11 014 01 0
15	6 31 11 015 01 0
15,5	6 31 11 016 01 0



HSS TWIST DRILL WITH 3/4" WELDON FITTING
Cutting depth 35 mm

Bore Ø mm	Part number
5	6 31 11 036 01 0
6	6 31 11 018 01 0
6,8	6 31 11 034 01 0
7	6 31 11 019 01 0
8	6 31 11 020 01 0
8,5	6 31 11 035 01 0
9	6 31 11 021 01 0
10	6 31 11 022 01 0
10,2	6 31 11 037 01 0
11	6 31 11 023 01 0
12	6 31 11 024 01 0
13	6 31 11 025 01 0
14	6 31 11 026 01 0
15	6 31 11 027 01 0
16	6 31 11 028 01 0

DRIVE ARBORS



QUICKIN-ADAPTORS
With internal cooling lubricant supply.
Tool-free core drill bit changes.

Cutting depth mm	Taper	Bore Ø mm	Part number
50	MT 2	12 - 35	6 39 01 065 02 0
75	MT 2	12 - 35	6 39 01 066 02 0
50	MK 3	12 - 65	6 39 01 048 02 0
75	MK 3	12 - 65	6 39 01 049 02 0



3/4" WELDON MOUNTING SHAFT
With internal cooling lubricant supply.
Tool-free core drill bit changes.

Cutting depth mm	Taper	Bore Ø mm	Part number
50	MT 2	12 - 35	6 39 01 063 02 0
75	MT 2	12 - 35	6 39 01 064 02 0
50	MK 3	12 - 65	6 39 01 050 02 0
75	MK 3	12 - 65	6 39 01 051 02 0



3/4" WELDON MOUNTING SHAFT
With internal cooling lubricant supply.

Cutting depth mm	Taper	Bore Ø mm	Part number
50	MK 3	12 - 65	6 39 01 074 02 0
75	MK 3	12 - 65	6 39 01 073 02 0



WELDON 32 MOUNTING SHAFT
For all Weldon 32 core drill bits.

Cutting depth mm	Taper	Bore Ø mm	Part number
50	MT 4	50 - 100	6 39 01 072 02 0



QUICKIN-ADAPTORS
for using FEIN core drills on bench and column drilling machines and all other core drilling units with MT fitting.
Tool-free core drill bit changes.

Cutting depth mm	Taper	Bore Ø mm	Part number
50	MK 3	12 - 65	6 39 01 019 01 3
50	MT 2	12 - 35	6 39 01 018 01 9
75	MK 3	12 - 65	6 39 01 055 02 0
75	MT 2	12 - 35	6 39 01 057 02 0



3/4" WELDON MOUNTING SHAFT
for using FEIN core drills on bench and column drilling machines and all other core drilling units with MT fitting.
Tool-free core drill bit changes.

Cutting depth mm	Taper	Bore Ø mm	Part number
50	MK 3	12 - 65	6 39 01 052 02 0
75	MK 3	12 - 65	6 39 01 053 02 0



QUICKIN OUTPUT
For retrofitting KBM 80 U / KBM 80 auto. With integrated cooling lubricant supply. For all QuickIN core bits with a Ø of 12 - 65 mm.

Cutting depth mm	Taper	Bore Ø mm	Part number
50	MK 3	12 - 65	6 39 01 039 02 0



QUICKIN MAX OUTPUT
For retrofitting KBM 80 U / KBM 80 auto. With integrated cooling lubricant supply. For all FEIN QuickIN MAX core bits with a Ø of 50-80 mm.

Cutting depth mm	Taper	Bore Ø mm	Part number
50	MK 3	50 - 80	6 39 01 038 02 0



WELDON 32 OUTPUT
For all Weldon 32 core drill bits.

Cutting depth mm	Taper	Bore Ø mm	Part number
50	MK 3	50 - 80	6 39 01 041 01 0



ENLARGEMENT TAPERS
for M.T. sockets

Mount	Part number
MT 3/MT 3	6 33 04 005 00 0

TAPPING

**SIZE 2 TAPPING QUICK-CHANGE CHUCK WITH 3/4" WELDON FITTING**

Can only be used for magnetic core drills with reverse running function. For tapping drills in accordance with DIN 371 and 374/376, in conjunction with tapping inserts with or without M6 - M20 safety clutch.

Part number

9 26 02 089 01 0

**SIZE 2 TAPPING QUICK-CHANGE CHUCK WITH QUICKIN FITTING**

Can only be used for magnetic core drills with reverse running function. For tapping drills in accordance with DIN 371 and 374/376, in conjunction with tapping inserts with or without M6 - M20 safety clutch.

Part number

9 26 02 079 01 0

**TAPPING INSERTS**

for thread drills in accordance with DIN 371

Thread	Ø mm	Square mm	Part number
M 6	6	4,9	6 32 06 095 01 1
M 8	8	6,2	6 32 06 138 01 0
M 10	10	8	6 32 06 139 01 0

**TAPPING INSERTS**

for thread drills in accordance with DIN 374/376

Thread	Ø mm	Square mm	Part number
M 6	4,5	3,4	6 32 06 117 01 5
M 10	7	5,5	6 32 06 096 01 4
M 12	9	7	6 32 06 097 01 8
M 14	11	9	6 32 06 098 01 6
M 16	12	9	6 32 06 099 01 0
M 18	14	11	6 32 06 100 01 1
M 20	16	12	6 32 06 101 01 0

**TAPPING INSERTS**

with safety coupling for blind holes.
for thread drills in accordance with DIN 371

Thread	Ø mm	Square mm	Part number
M 6	6	4,9	6 32 06 118 01 3
M 8	8	6,2	6 32 06 140 01 0
M 10	10	8	6 32 06 141 01 0

**TAPPING INSERTS**

with safety coupling for blind holes.
for thread drills in accordance with DIN 374/376

Thread	Ø mm	Square mm	Part number
M 8	6	4,9	6 32 06 102 01 3
M 10	7	5,5	6 32 06 103 01 7
M 12	9	7	6 32 06 104 01 5
M 14	11	9	6 32 06 105 01 9
M 16	12	9	6 32 06 106 01 2
M 18	14	11	6 32 06 107 01 6
M 20	16	12	6 32 06 108 01 4

**SIZE 3 TAPPING QUICK-CHANGE CHUCK WITH QUICKIN MAX/WELDON 32 FITTING**

Can only be used for magnetic core drills with reverse running function. For tapping drills in accordance with DIN 374/376, in conjunction with tapping inserts with or without M22 - M36 safety clutch.

Part number

9 26 02 082 01 0

**TAPPING INSERTS**

for thread drills in accordance with DIN 374/376

Thread	Ø mm	Square mm	Part number
M22/M24	18	14,5	6 32 06 119 01 0
M 27	20	16	6 32 06 120 01 0
M 30	22	18	6 32 06 121 01 0
M 33	25	20	6 32 06 157 01 0
M 36	28	22	6 32 06 158 01 0

**TAPPING INSERTS**

with safety coupling for blind holes.
for thread drills in accordance with DIN 374/376

Thread	Ø mm	Square mm	Part number
M22/M24	18	14,5	6 32 06 122 01 0
M 27	20	16	6 32 06 123 01 0
M 30	22	18	6 32 06 124 01 0
M 33	25	20	6 32 06 155 01 0
M 36	28	22	6 32 06 156 01 0

**INTERCHANGEABLE REDUCING INSERT (SIZE 3 TO SIZE 2)**

Reducing insert for holding size 2 tapping inserts (M6-M20) in size 3 tapping quick change chuck (9 26 02 082 01 0).

Part number

6 32 06 125 01 0

**ADAPTER WITH 3/4" WELDON FITTING**

1/4" hexagonal output in accordance with DIN 3126/ISO 1173 - C 6.3

Part number

6 32 06 148 01 0

**ADAPTER WITH 3/4" WELDON FITTING**

6 mm round shank output for M5-M8 in accordance with DIN 352/ISO 13

Ø mm	Square mm	Part number
6	4,9	6 32 06 146 01 0

**ADAPTER WITH 3/4" WELDON FITTING**

7 mm round shank output for M10 in accordance with DIN 352/ISO 13

Ø mm	Square mm	Part number
7	5,5	6 32 06 147 01 0



ADAPTER WITH 3/4" WELDON FITTING

9 mm round shank output for M12 in accordance with DIN 352/ISO 13

Ø mm	Square mm	Part number
9	7	6 32 06 149 01 0



TAPPING DRILL FOR THROUGH HOLES WITH ADAPTER WITH 3/4" WELDON FITTING

Short version in accordance with DIN 352/ISO 13.

Thread	Part number
M 6	6 31 10 019 03 0
M 8	6 31 10 020 03 0
M 10	6 31 10 021 03 0
M 12	6 31 10 022 03 0



HSS 90° COUNTERSINK BIT

With 1/4" hexagon in accordance with DIN 3126/ISO 1173 – C 6.3

Ø mm	Part number
16,5	6 31 11 038 01 0



HSS 90° COUNTERSINK BIT WITH ADAPTER WITH 3/4" WELDON FITTING

Ø mm	Part number
16,5	6 31 11 038 02 0



TAPPING DRILL SET FOR THROUGH HOLES

Comprising 1 x M6 threading drill in accordance with DIN 352/ISO 13 with 3/4" Weldon adapter, 1 x HSS twist drill, 5 mm in diameter, with 3/4" Weldon fitting and 1 x HSS 90° countersink bit, 16.5 mm in diameter, with 3/4" Weldon adapter and 1 x hexagon socket wrench in a handy plastic storage box.

Thread	Part number
M 6	6 31 10 019 02 0



TAPPING DRILL SET FOR THROUGH HOLES

Comprising 1 x M8 threading drill in accordance with DIN 352/ISO 13 with 3/4" Weldon adapter, 1 x HSS twist drill, 6.8 mm in diameter, with 3/4" Weldon fitting and 1 x HSS 90° countersink bit, 16.5 mm in diameter, with 3/4" Weldon adapter and 1 x hexagon socket wrench in a handy plastic storage box.

Thread	Part number
M 8	6 31 10 020 02 0



TAPPING DRILL SET FOR THROUGH HOLES

Comprising 1 x M10 threading drill in accordance with DIN 352/ISO 13 with 3/4" Weldon adapter, 1 x HSS twist drill, 8.5 mm in diameter, with 3/4" Weldon fitting and 1 x HSS 90° countersink bit, 16.5 mm in diameter, with 3/4" Weldon adapter and 1 x hexagon socket wrench in a handy plastic storage box.

Thread	Part number
M 10	6 31 10 021 02 0



TAPPING DRILL SET FOR THROUGH HOLES

Comprising 1 x M12 threading drill in accordance with DIN 352/ISO 13 with 3/4" Weldon adapter, 1 x HSS twist drill, 10.2 mm in diameter, with 3/4" Weldon fitting and 1 x HSS 90° countersink bit, 16.5 mm in diameter, with 3/4" Weldon adapter and 1 x hexagon socket wrench in a handy plastic storage box.

Thread	Part number
M 12	6 31 10 022 02 0

CLAMPING FIXTURES



VACUUM PLATE

for anti-magnetic materials and structured bases (corrugated sheet, stud plate etc.)
Vacuum plate 396 x 200 x 95 mm

Part number
9 26 02 057 01 7



VACUUM PUMP

Suction rate 0,015 m³/min, -0,8 bar, 92 W, weight 2,5 kg including suction hose

Part number
9 26 01 022 01 3



SUCTION PLATE

for anti-magnetic materials, 250 x 330 x 110 mm

Part number
9 26 02 054 01 6



PIPE DRILLING DEVICE

incl. clamping strap, for positioning bores on pipes with pipe Ø of 60 to 300 mm, 220 x 130 mm.

Part number
9 26 02 055 01 0

COOLING



PUMP

Capacity approx. 450 ml.

Part number
3 21 32 022 00 7

REPLACEMENT HOSE

for hand pump 3 21 32 022 00 7.

Part number
3 14 14 054 00 8



FLEX-JOINTED HOSE

For applications using twist drills.

L mm	Part number
340	3 14 14 070 01 0
500	3 14 14 078 01 0

**CUTTING PASTE**

Lubricating agents for working on sheet metals.

Part number

3 21 32 020 12 9

OTHER ACCESSORIES**MAGBRUSH**

Practical tool with high magnetic force for quick and easy collection of magnetic metal swarf.

Part number

6 42 01 005 01 0

AKBU ACCESSORIES**HIGHPOWER BATTERY PACK**

HighPower Li-ion battery with cells capable of handling high currents, charge status indicator and FEIN SafetyCell technology. Continually high power output with 75 % higher current rating than a Li-ion battery. Recommended for FEIN cordless magnetic core drills and cordless angle grinders. Can be used with all FEIN 18 V cordless tools.

Current/Voltages V	Capacity Ah	Weight kg	Part number
18	5,2	0,75	9 26 04 179 02 0

**HIGHPOWER BATTERY STARTER SET**

2 HighPower Li-ion batteries with ALG 80 rapid charger. Bluetooth® connectivity for connecting to a mobile end device and for use with the my.FEIN app. Shows the current charge state and the number of charge cycles to date on your smartphone or tablet. Provides notification when the battery is fully charged. Short charge times thanks to high charge current of 8 amps and process-controlled charge management. Large LED display with charge indicator and USB port for mobile charging of small electrical devices. For all FEIN Li-ion batteries. Charge times (80 % of max. capacity): 12 and 18 V / 3 Ah: 31 min., 12 and 18 V / 6 Ah: 38 min., 18 V / 5.2 Ah: 33 min.

Current/Voltages V	Capacity Ah	Part number
18	5,2	9 26 04 325 01 0

**CORDLESS ALED 12-18 V LED LAMP**

Compact and durable cordless LED lamp with swivel-mounted lamp head. Compatible with all 12 / 14 / 18 V FEIN Li-ion batteries, including hook for attaching the lamp. Extremely lightweight at 130 g and very bright at 900 Lux. Colour temperature is the equivalent of daylight. The brightness can be set to 2 levels.

Part number

9 26 04 200 02 0

**AUSB 12-18 V CORDLESS USB ADAPTER**

Compact cordless USB adapter for charging smartphones, tablets etc. without a mains connection. 2 high-speed USB charging ports for rapid charging at 2x 1.2 amps. Suitable for iOS and Android. Compatible with all 12 / 14 / 18 V FEIN Li-ion batteries.

Part number

9 26 04 201 02 0

**QUICK CHARGER ALG 80 BC**

Bluetooth® connectivity for connecting to a mobile end device and for use with the my.FEIN app. Shows the current charge state and the number of charge cycles to date on your smartphone or tablet. Provides notification when the battery is fully charged. Short charge times thanks to high charge current of 8 amps and process-controlled charge management. Large LED display with charge indicator and USB port for mobile charging of small electrical devices. For all FEIN Li-ion batteries. Charge times (80 % of max. capacity): 12 and 18 V / 3 Ah: 31 min., 12 and 18 V / 6 Ah: 38 min., 18 V / 5.2 Ah: 33 min.

Part number

9 26 04 210 01 0



WET / DRY DUST EXTRACTOR

WET / DRY DUST EXTRACTOR **190**

For clean results and safe, healthy working conditions.



		FEIN DUSTEX 25 L SET	FEIN DUSTEX 25 L	FEIN DUSTEX 35 L SET	FEIN DUSTEX 35 L
		Compact, powerful wet and dry dust extractor for connecting to power tools when working in the workshop and for assembly work, with large accessory set.	Compact, powerful wet and dry dust extractor for connecting to power tools when working in the workshop and for assembly work.	Powerful wet and dry dust extractor for connecting to power tools when working in the workshop and for assembly work, with large accessory set.	Powerful wet and dry dust extractor for connecting power tools when working in the workshop and for assembly work.
PAGE		192	192	192	193
Automatic start/stop		•	•	•	•
Soft start		•	•	•	•
Automatic filter cleaning					
Anti-static function		o	o	o	o
Case storage					
Dust class		L	L	L	L
Maximum power input	W	1 380	1 380	1 380	1 380
Air flow	l/min	4,320	4,320	4,320	4,320
Max. vacuum	hPa	253	253	253	253
Tank volume	l	22	22	32	32
Cable with plug	m	7,5	7,5	7,5	7,5
Weight according to EPTA	kg	8	8	9	9

o optional • included

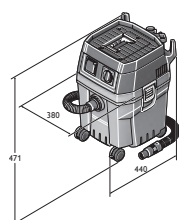

FEIN Dustex 25 L

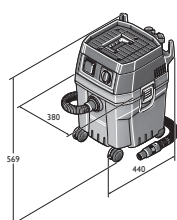

FEIN Dustex 35 L

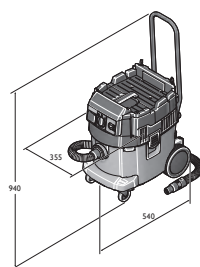

FEIN Dustex 35 LX
FEIN Dustex 35 LX AC

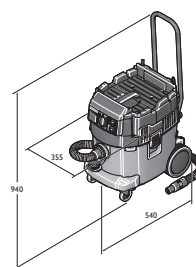

FEIN Dustex 35 MX
FEIN Dustex 35 MX AC

FEIN DUSTEX 25 L SET

Compact, powerful wet and dry dust extractor for connecting to power tools when working in the workshop and for assembly work, with large accessory set.

**SUPPLIED**

1x 4 m suction hose, diameter 35 mm, 1 tool collar with suction force regulation, 1 Fleece filter bag, 1 Flat-fold filter, 2 suction pipes (metal), 1 combi nozzle with interchangeable inserts, 1 groove nozzle, 1 suction brush, 1 elbow

For accessories, see page 195

Maximum power input	W	1 380
Air flow	l/min	4,320
Max. vacuum	hPa	253
Tank volume	l	22
Cable with plug	m	7,5
Weight according to EPTA	kg	8

Part number	9 20 35 060 00 0
EAN	4014586891828

FEIN BENEFITS

- + Powerful turbine for 72 l/s volumetric flow and 253 mbar vacuum (240 V).
- + Low noise level of 67 dB (A).
- + The 7.5 m mains cable and 4 m hose provide a large working radius.
- + Anti-static function for preventing static charging during work – electrostatically discharging thanks to optional suction hose 3 13 45 120 01 0 and tool collar 3 13 45 300 01 0.
- + Large, 360° rotating castors for optimum manoeuvrability even in tight spaces.
- + Tool collar with suction force regulation to set the suction power with ease.
- + Auto start socket with switch-on delay to avoid power surges.
- + Practical storage area with edge.
- + Approval for dust class L.

FEIN DUSTEX 25 L

Compact, powerful wet and dry dust extractor for connecting to power tools when working in the workshop and for assembly work.

**SUPPLIED**

1x 4 m suction hose, diameter 35 mm, 1 tool collar with suction force regulation, 1 Fleece filter bag, 1 Flat-fold filter

For accessories, see page 195

Maximum power input	W	1 380
Air flow	l/min	4,320
Max. vacuum	hPa	253
Tank volume	l	22
Cable with plug	m	7,5
Weight according to EPTA	kg	8

Part number	9 20 35 223 00 0
EAN	4014586891866

FEIN BENEFITS

- + Powerful turbine for 72 l/s volumetric flow and 253 mbar vacuum (240 V).
- + Low noise level of 67 dB (A).
- + The 7.5 m mains cable and 4 m hose provide a large working radius.
- + Anti-static function for preventing static charging during work – electrostatically discharging thanks to optional suction hose 3 13 45 120 01 0 and tool collar 3 13 45 300 01 0.
- + Large, 360° rotating castors for optimum manoeuvrability even in tight spaces.
- + Tool collar with suction force regulation to set the suction power with ease.
- + Auto start socket with switch-on delay to avoid power surges.
- + Practical storage area with edge.
- + Approval for dust class L.

FEIN DUSTEX 35 L SET

Powerful wet and dry dust extractor for connecting to power tools when working in the workshop and for assembly work, with large accessory set.

**SUPPLIED**

1 tool collar with suction force regulation, 1 combi nozzle with interchangeable inserts, 1x 4 m suction hose, diameter 35 mm, 1 suction brush, 1 elbow, 2 suction pipes (metal), 1 groove nozzle, 1 Flat-fold filter, 1 Fleece filter bag

For accessories, see page 195

Maximum power input	W	1 380
Air flow	l/min	4,320
Max. vacuum	hPa	253
Tank volume	l	32
Cable with plug	m	7,5
Weight according to EPTA	kg	9

Part number	9 20 36 060 00 0
EAN	4014586891903

FEIN BENEFITS

- + Powerful turbine for 72 l/s volumetric flow and 253 mbar vacuum (240 V).
- + Low noise level of 67 dB (A).
- + The 7.5 m mains cable and 4 m hose provide a large working radius.
- + Anti-static function for preventing static charging during work – electrostatically discharging thanks to optional suction hose 3 13 45 120 01 0 and tool collar 3 13 45 300 01 0.
- + Large, 360° rotating castors for optimum manoeuvrability even in tight spaces.
- + Tool collar with suction force regulation to set the suction power with ease.
- + Auto start socket with switch-on delay to avoid power surges.
- + Practical storage area with edge.
- + Approval for dust class L.

FEIN DUSTEX 35 L**SUPPLIED**

1x 4 m suction hose, diameter 35 mm, 1 tool collar with suction force regulation, 1 Fleece filter bag, 1 Flat-fold filter

For accessories, see page 195

Powerful wet and dry dust extractor for connecting power tools when working in the workshop and for assembly work.

Maximum power input	W	1 380
Air flow	l/min	4,320
Max. vacuum	hPa	253
Tank volume	l	32
Cable with plug	m	7,5
Weight according to EPTA	kg	9

Part number	9 20 36 223 00 0
EAN	4014586891941

FEIN BENEFITS

- + Powerful turbine for 72 l/s volumetric flow and 253 mbar vacuum (240 V).
- + Low noise level of 67 dB (A).
- + The 7.5 m mains cable and 4 m hose provide a large working radius.
- + Anti-static function for preventing static charging during work – electrostatically discharging thanks to optional suction hose 3 13 45 120 01 0 and tool collar 3 13 45 300 01 0.
- + Large, 360° rotating castors for optimum manoeuvrability even in tight spaces.
- + Auto start socket with switch-on delay to avoid power surges.
- + Approval for dust class L.
- + Practical storage area with edge.
- + Tool collar with suction force regulation to set the suction power with ease.

FEIN DUSTEX 35 LX**SUPPLIED**

1 push bar, 1 PES flat fold filter, 1 premium fleece filter bag, 1x 4 m suction hose, diameter 35 mm, 1 tool collar with suction force regulation, 1 stepped collar, 2 suction pipes (metal), 1 combi nozzle with interchangeable inserts, 1 crevice nozzle, 1 suction brush, 1 elbow

For accessories, see page 195

Powerful, professional wet/dry dust extractor of dust class L for attachment of various case systems including extensive accessories.

Maximum power input	W	1 380
Air flow	l/min	4,320
Max. vacuum	hPa	254
Tank volume	l	35
Cable with plug	m	7,5
Sound pressure level	dB	67
Weight according to EPTA	kg	13,5

Part number	9 20 29 060 00 0
EAN	4014586882956

FEIN BENEFITS

- + Tool cases of various systems can be simply positioned on the extraction head and secured.
- + Ergonomic transport of the complete unit, including power tool and extractor, thanks to push bar and case and accessory attachment.
- + Reliable suction of different types of dirt from liquids to fine dusts.
- + Approval for dust class L.
- + With PES flat fold filter and electronic shut-off for outstanding wet extraction performance.
- + Auto start socket with switch-on delay to avoid power surges.
- + Infinitely variable suction force regulation on the extractor.
- + The 7.5 m mains cable and 4 m hose provide a large working radius.
- + Anti-static function for preventing static charging during work - electrostatically discharging thanks to optional suction hose 3 13 45 120 01 0.

FEIN DUSTEX 35 LX AC**SUPPLIED**

1 push bar, 1 PES flat fold filter, 1 disposal bag, 1x 4 m suction hose, diameter 35 mm, 1 tool collar with suction force regulation, 1 stepped collar, 2 suction pipes (metal), 1 combi nozzle with interchangeable inserts, 1 crevice nozzle, 1 suction brush, 1 elbow

For accessories, see page 195

Powerful, professional wet/dry dust extractor of dust class L with fully automatic filter cleaning for attachment of various case systems including extensive accessories.

Maximum power input	W	1 380
Air flow	l/min	4,320
Max. vacuum	hPa	254
Tank volume	l	35
Cable with plug	m	7,5
Sound pressure level	dB	67
Weight according to EPTA	kg	14,1

Part number	9 20 30 060 00 0
EAN	4014586882994

FEIN BENEFITS

- + Tool cases of various systems can be simply positioned on the extraction head and secured.
- + Ergonomic transport of the complete unit, including power tool and extractor, thanks to push bar and case and accessory attachment.
- + Fully automatic filter cleaning (AC) makes the flat fold filter last longer for uninterrupted working.
- + Reliable suction of different types of dirt from liquids to fine dusts.
- + Approval for dust class L.
- + With PES flat fold filter and electronic shut-off for outstanding wet extraction performance.
- + Auto start socket with switch-on delay to avoid power surges.
- + Infinitely variable suction force regulation on the extractor.
- + The 7.5 m mains cable and 4 m hose provide a large working radius.
- + Anti-static function for preventing static charging during work - electrostatically discharging thanks to optional suction hose 3 13 45 120 01 0.

FEIN DUSTEX 35 MX

Powerful, professional wet/dry dust extractor of dust class M for attachment of various case systems including extensive accessories.

**SUPPLIED**

1 push bar, 1 PES flat fold filter, 1 premium fleece filter bag, 1x 4 m ES suction hose, diameter 35 mm, 1 tool collar with suction force regulation, 1 stepped collar, 2 suction pipes (metal), 1 combi nozzle with interchangeable inserts, 1 crevice nozzle, 1 suction brush, 1 elbow

For accessories, see page 195

Maximum power input	W	1 380
Air flow	l/min	4,320
Max. vacuum	hPa	254
Tank volume	l	35
Cable with plug	m	7,5
Sound pressure level	dB	67
Weight according to EPTA	kg	13,5

Part number	9 20 31 060 00 0
EAN	4014586883052

FEIN BENEFITS

- + Approved for holding hazardous dusts of class M.
- + Tool cases of various systems can be simply positioned on the extraction head and secured.
- + Ergonomic transport of the complete unit, including power tool and extractor, thanks to push bar and case and accessory attachment.
- + Reliable suction of different types of dirt from liquids to fine dusts.
- + With PES flat fold filter and electronic shut-off for outstanding wet extraction performance.
- + Auto start socket with switch-on delay to avoid power surges.
- + Infinitely variable suction force regulation on the extractor.
- + The 7.5 m mains cable and 4 m hose provide a large working radius.
- + Anti-static function for preventing static charging during work - electrostatically discharging.

FEIN DUSTEX 35 MX AC

Powerful, professional wet/dry dust extractor of dust class M with fully automatic filter cleaning for attachment of various case systems including extensive accessories.

**SUPPLIED**

1 push bar, 1 PES flat fold filter, 1 disposal bag, 1x 4 m ES suction hose, diameter 35 mm, 1 tool collar with suction force regulation, 1 stepped collar, 2 suction pipes (metal), 1 combi nozzle with interchangeable inserts, 1 crevice nozzle, 1 suction brush, 1 elbow

For accessories, see page 195

Maximum power input	W	1 380
Air flow	l/min	4,320
Max. vacuum	hPa	254
Tank volume	l	35
Cable with plug	m	7,5
Sound pressure level	dB	67
Weight according to EPTA	kg	14,1

Part number	9 20 32 060 00 0
EAN	4014586883069

FEIN BENEFITS

- + Approved for holding hazardous dusts of class M.
- + Tool cases of various systems can be simply positioned on the extraction head and secured.
- + Fully automatic filter cleaning (AC) makes the flat fold filter last longer for uninterrupted working.
- + Ergonomic transport of the complete unit, including power tool and extractor, thanks to push bar and case and accessory attachment.
- + Reliable suction of different types of dirt from liquids to fine dusts.
- + With PES flat fold filter and electronic shut-off for outstanding wet extraction performance.
- + Auto start socket with switch-on delay to avoid power surges.
- + Infinitely variable suction force regulation on the extractor.
- + The 7.5 m mains cable and 4 m hose provide a large working radius.
- + Anti-static function for preventing static charging during work - electrostatically discharging.

GENERAL ACCESSORIES



FLAT-FOLD FILTER
Cellulose, M dust class certification

Part number
3 13 45 012 01 0



FLAT-FOLD FILTER
PES, M dust class certification, superior filter

Part number
3 13 45 059 01 0



FLAT-FOLD FILTER
HEPA

Part number
3 13 45 060 01 0



SUCTION HOSE

Ø mm	L m	Part number
27	4	3 13 45 065 01 0
35	4	3 13 45 066 01 0



ANTISTATIC SUCTION HOSE
Electrostatically discharging, orange-black.

Ø mm	L m	Part number
27	4	3 13 45 121 01 0
35	4	3 13 45 120 01 0



EXTENSION HOSE

Ø mm	L m	Part number
27	2,5	3 13 45 067 01 0
35	2,5	3 13 45 068 01 0



REPAIR SET
Suitable for 35 mm diameter suction hose

Part number
3 13 45 069 01 0



ELBOW

Part number
3 13 45 070 01 0



ELBOW
with leak air aperture.

Part number
3 13 45 263 01 0



SUCTION TUBE
Metal version, pack of 2

Part number
3 13 45 071 01 0



FLOOR NOZZLE
Reversible, with stainless steel sliding surface and all-round bristles. Suitable for hard floors and textile floor coverings

Part number
3 13 45 072 01 0



COMBINATION NOZZLE
For wet and dry work with interchangeable inserts, rubber lips and brush strips

Part number
3 13 45 073 01 0



CREVICE NOZZLE

Part number
3 13 45 074 01 0



UPHOLSTERY NOZZLE
With brush strips

Part number
3 13 45 075 01 0



SUCTION BRUSH,
can be rotated, with natural bristles, 70 x 45 mm bristle area

Part number
3 13 45 076 01 0



INTAKE BRUSH
Natural bristles, 120 x 45 mm bristle area

Part number
3 13 45 077 01 0



ANTISTATIC TOOL COLLAR
Electrically conducting, with suction force regulation, for hose diameter 35 mm, power tool connection (diameter 38 mm).

Part number
3 13 45 123 01 0



ANTISTATIC TOOL COLLAR
Electrically conducting, with suction force regulation, for hose diameter 35 mm, power tool connection (diameter 27 mm).

Part number
3 13 45 300 01 0



STEPPED COLLAR
4 levels

Part number
3 13 45 079 01 0



CABLE HOLDER
to guide cable on suction hose, suitable for suction hose diameter of 27-35 mm

No. in pack pcs	Part number
5	3 13 45 119 01 0



ACCESSORY SET
2 suction pipes (metal), 1 combi nozzle with interchangeable inserts, 1 crevice nozzle, 1 suction brush, 1 elbow

Part number
3 13 45 071 02 0



ACCESSORY SET
1 suction hose, 2 suction pipes (metal), 1 combi nozzle with interchangeable inserts, 1 crevice nozzle, 1 suction brush, 1 elbow

Part number
3 13 45 133 02 0

ACCESSORIES FOR DUSTEX 35 LX / MX



DISPOSAL BAG
Open, recommended for AC models only

No. in pack pcs	Part number
5	3 13 45 063 01 0



PREMIUM FLEECE FILTER BAG
Particularly strong, tear-resistant fleece with seams with additional reinforcement for fine, abrasive dusts. 2-3times greater effective capacity than paper filter bags.

Model	No. in pack pcs	Part number
Dustex 35 L	5	3 13 45 251 01 0

ACCESSORIES FOR FEIN DUSTEX 35 L



FLEECE FILTER BAG
Particularly tear-resistant fleece. 2-3 times greater effective capacity than paper filter bags.

Model	No. in pack pcs	Part number
Dustex 35 L	5	3 13 45 062 01 0



PREMIUM FLEECE FILTER BAG
Particularly strong, tear-resistant fleece with seams with additional reinforcement for fine, abrasive dusts. 2-3 times greater effective capacity than paper filter bags.

Model	No. in pack pcs	Part number
Dustex 35 L	5	3 13 45 251 01 0



PERMANENT FILTER
Replaces the fleece filter bag

Part number
3 13 45 064 01 0



HEPA FILTER BAG

No. in pack pcs	Part number
3	3 13 45 130 01 0

ACCESSORIES FOR FEIN DUSTEX 25 L



FLEECE FILTER BAG
Particularly tear-resistant fleece. 2-3times greater effective capacity than paper filter bags.

Model	No. in pack pcs	Part number
Dustex 25 L	5	3 13 45 061 01 0



PREMIUM FLEECE FILTER BAG
Particularly strong, tear-resistant fleece with seams with additional reinforcement for fine, abrasive dusts. 2-3times greater effective capacity than paper filter bags.

Model	No. in pack pcs	Part number
Dustex 25 L	5	3 13 45 273 01 0



PERMANENT FILTER
Replaces the fleece filter bag

Part number
3 13 45 064 01 0

ACCESSORIES FOR DUSTEX II, DUSTEX 25, DUSTEX 40



FILTER BAG
Extra fine version for higher levels of material separation, pack of 5

Model	Part number
Dustex II, 25	3 13 22 757 01 6
Dustex 40	3 13 22 811 01 0



FILTER BAG
Standard version, pack of 5

Model	Part number
Dustex 40	3 13 22 810 01 0

**FILTER CARTRIDGE**

Part number

3 13 22 765 00 9

**SUCTION HOSE**

Ø 36 mm, length 5 m

Part number

3 13 22 767 01 5

**CONNECTING PIECE**

Universal device to connect power tools and accessories with dust extraction to vacuum cleaner. Flexible rubber sleeve, length 70 mm, inner diameter 31.5 mm.

Part number

3 13 22 771 00 9

**STEPPED COLLAR**

for various connection diameters, e.g. for connecting up equipment from other manufacturers.

Part number

3 13 22 772 00 2



SURFACE PROCESSING

SANDERS **200**

The perfect tools for rough sanding and fine sanding of surfaces, pipes and profiles.

POLISHERS **211**

Protecting and caring for sensitive and high-quality surfaces.



WSG 17-70 INOX STARTER SET	WPO 14-25 E	WPO 14-25 E - STAINLESS STEEL START SET	KS 10-38 E SET	BF 10-280 E	BF 10-280 E START-SET
Stainless steel starter set for preparing to finish surfaces, pipesand profiles.	Extremely powerful sander/polisher for cool machining of stainless steel surfaces.	Stainless steel starter set for standard applications in surface machining.	Fillet weld grinder for difficult-to-reach spots in metal constructions.	Extremely powerful belt file for corners and edges in stainless steel machining.	Start set belt file for corners and edges in stainless steel machining.

PAGE		201	201	201	202	202	202
Polishing		++	++	++	++	++	++
Rough sanding		++	++	++	++	++	++
Fine sanding		++	++	++	++	++	++
Dry sanding		++	++	++	++	++	++
Micro-sanding		++	++	++	++	++	++
Soft start		•	•	•	•	•	•
Restart protection		•	•	•	•	•	•
FEIN high-power motor		•	•	•	•	•	•
Spindle lock		•	•	•			
Input	W	1 700	1 200	1 200	800	800	800
Output	W	1 000	750	750	550	550	550
Speed, no load	rpm	2,700 - 8,500	900 - 2,500	900 - 2,500	1,350 - 3,750	10,000 - 28,000	10,000 - 28,000
Sanding pad Ø	mm	125	230	230			
Polishing disc Ø	mm	125	230	230			
Belt speed	m/sec					12 - 32	12 - 32
Mounting thread		M 14	M 14	M 14			
Belt size	mm					520 x 3/6/20	520 x 3/6/20
Peripheral speed	m/sec				29,5		
Tool diameter	mm				150		
Cable with plug	m	4	4	4	4	4	4
Weight according to EPTA	kg	2,4	2,5	2,5	3,2	2,1	2,1

++ optimal suitability • included

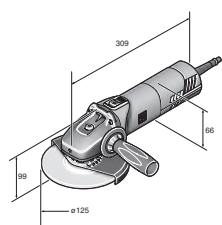

WSG 17-70 Inox

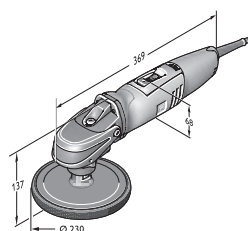

WPO 14-25 E



KS 10-38 E



BF 10-280 E

WSG 17-70 INOX STARTER SET



SUPPLIED

1 serrated sanding disc, medium,
1 finishing disc (diameter 125 mm),
5 each of Pyramix sanding sheet,
perforated, diameter 115 mm (grit
280, 400, 800), 25 sanding sheets
(grit 80, diameter 115mm), 1 cooling
backing pad (diameter 75 mm,
M14), 1 supporting plate with velcro
adhesion section (Ø 115 mm, M14),
1 plastic carrying case

For accessories, see page 203

Stainless steel starter set for preparing to finish surfaces, pipesand profiles.

Input	W	1 700
Output	W	1 000
Sanding pad Ø	mm	125
Speed, no load	rpm	2,700 - 8,500
Polishing disc Ø	mm	125
Mounting thread		M 14
Cable with plug	m	4
Weight according to EPTA	kg	2,4

Part number	7 222 13 61 00 0
EAN	4014586883564

FEIN BENEFITS

- + POWERtronic for enormous power, power reserve and exceptional speed stability under load.
- + Variable speed allows various tools to be used for applications ranging from satin-finishing to sanding stainless steel.
- + Longer carbon brush life and tool removes more material than comparable angle grinders.
- + Industrial cable H07, length 4m.
- + The best vibration performance in its class.
- + Restart protection.
- + Solid metal gearbox head for maximum robustness and service life.
- + Electronic overload protection.
- + Blockage monitoring.
- + The lightest and shortest model of its kind.
- + Soft start.

WPO 14-25 E



SUPPLIED

1 anti-vibration handle

For accessories, see page 203

Extremely powerful sander/polisher for cool machining of stainless steel surfaces.

Input	W	1 200
Output	W	750
Sanding pad Ø	mm	230
Speed, no load	rpm	900 - 2,500
Polishing disc Ø	mm	230
Mounting thread		M 14
Cable with plug	m	4
Weight according to EPTA	kg	2,5

Part number	7 221 49 00 23 0
EAN	4014586862729

FEIN BENEFITS

- + Extremely powerful even at low speeds thanks to mechanical gear reduction and FEIN high power motor.
- + Infinitely variable speed, ideal for sanding, satin finishing, brushing and high-gloss polishing of stainless steel.
- + Universal suitability as fully-functional sander, polisher and satin-finisher.
- + Excellent handling.
- + Spindle lock.
- + Right or left-handed operation.
- + Restart protection.
- + Soft start.
- + H 07 industrial cable.
- + Dustproof ball bearing.
- + Carbon brushes with self cut-off function.
- + Comprehensive range of accessories available.

WPO 14-25 E - STAINLESS STEEL START SET



SUPPLIED

1 holder, rotating, safety guard,
1 work arbour, 1 corrugated sanding
fleece, 1 supporting plate with
velcro adhesion section (Ø 115 mm,
M14), 10 sanding fleeces with velcro
(Ø 115 mm, fine), 1 elastic sanding
roller (100 x 100 mm, grain 60),
1 lamella fleece cylinder
(100 x 100 mm, grain 180),
2 keys, 1 anti-vibration handle,
1 plastic carrying case

For accessories, see page 203

Stainless steel starter set for standard applications in surface machining.

Input	W	1 200
Output	W	750
Sanding pad Ø	mm	230
Speed, no load	rpm	900 - 2,500
Polishing disc Ø	mm	230
Mounting thread		M 14
Cable with plug	m	4
Weight according to EPTA	kg	2,5

Part number	7 221 49 50 01 0
EAN	4014586862743

FEIN BENEFITS

- + Extremely powerful even at low speeds thanks to mechanical gear reduction and FEIN high power motor.
- + Infinitely variable speed, ideal for sanding, satin finishing, brushing and high-gloss polishing of stainless steel.
- + Universal suitability as fully-functional sander, polisher and satin-finisher.
- + Excellent handling.
- + Spindle lock.
- + Right or left-handed operation.
- + Restart protection.
- + Soft start.
- + H 07 industrial cable.
- + Dustproof ball bearing.
- + Carbon brushes with self cut-off function.
- + Wide range of accessories.

KS 10-38 E SET**SUPPLIED**

1 anti-vibration handle, Medium fleece discs, diameter 150 mm, one 3 mm thick and one 6 mm thick, Fine fleece discs, diameter 150 mm, one 3 mm thick and one 6 mm thick, Profiling stone for profiling the fleece discs, 1 plastic carrying case

For accessories, see page 203

Fillet weld grinder for difficult-to-reach spots in metal constructions.

Input	W	800
Output	W	550
Speed, no load	rpm	1,350 - 3,750
Peripheral speed	m/sec	29,5
Tool diameter	mm	150
Cable with plug	m	4
Weight according to EPTA	kg	3,2

Part number	7 221 67 60 00 0
EAN	4014586868936

FEIN BENEFITS

- + Flexible use thanks to drive head that can be swivelled without the need for tools.
- + Flat design for corners, angles and difficult-to-reach spots.
- + Long belt drive service life thanks to zero-maintenance tensioning system.
- + Spindle brake for quick tool changes.
- + Spark hood can be adjusted and removed without the need for tools.
- + Electronic speed setting.
- + Made in Germany quality.
- + H 07 industrial cable.
- + Soft start.
- + Restart protection.

BF 10-280 E**SUPPLIED**

1 stepped grinding arm 3/6 mm (6 38 100 26 01 0)

For accessories, see page 203

Extremely powerful belt file for corners and edges in stainless steel machining.

Input	W	800
Output	W	550
Speed, no load	rpm	10,000 - 28,000
Belt speed	m/sec	12 - 32
Belt size	mm	520 x 3/6/20
Cable with plug	m	4
Weight according to EPTA	kg	2,1

Part number	7 228 05 50 00 0
EAN	4014586867250

FEIN BENEFITS

- + FEIN high-power motor for highly effective material removal and constant speed even at high loads.
- + Optimum belt speeds for effective use of various grinding, fleece and polishing belts.
- + Extremely easy to handle - tool-free, grinding arm can be swivelled 180°, tool-free belt installation and adjustment.
- + Perfect belt guidance.
- + Belt widths of between 3 and 20 mm.
- + Infinitely variable speed, ideal for protecting sensitive surfaces.
- + Stepped and straight grinding arms for a variety of applications.
- + Soft start.
- + Restart protection.
- + H 07 industrial cable.
- + Comprehensive range of accessories available.

BF 10-280 E START-SET**SUPPLIED**

3 grinding arms (1 each of 3/6 mm stepped, 6 mm straight, 20 mm straight), 10 grinding belts, 3 mm (grit 120), 10 grinding belts, 6 mm (grit 120), 10 grinding belts, 20 mm (grit 120), 5 fleece belts, 6 mm (medium), 1 plastic carrying case

For accessories, see page 203

Start set belt file for corners and edges in stainless steel machining.

Input	W	800
Output	W	550
Speed, no load	rpm	10,000 - 28,000
Belt speed	m/sec	12 - 32
Belt size	mm	520 x 3/6/20
Cable with plug	m	4
Weight according to EPTA	kg	2,1

Part number	7 228 05 51 00 0
EAN	4014586867267

FEIN BENEFITS

- + FEIN high-power motor for highly effective material removal and constant speed even at high loads.
- + Extremely easy to handle - tool-free, grinding arm can be swivelled 180°, tool-free belt installation and adjustment.
- + Start set with stepped and straight grinding arms for a variety of applications, ceramic grinding belts for effective machining of welded seams and fleece belts for finishing work in various widths.
- + Optimum belt speeds.
- + Perfect belt guidance.
- + Belt widths of between 3 and 20 mm.
- + Infinitely variable speed, ideal for protecting sensitive surfaces.
- + Soft start.
- + Restart protection.
- + H 07 industrial cable.
- + Comprehensive range of accessories available.

GENERAL ACCESSORIES



ANTI-VIBRATION HANDLE

M 8, vibration absorbing, to reduce the vibrations during longer jobs.

Part number
3 21 19 124 01 0



TOOL CASE

Plastic, inner dimensions: 470 x 275 x 116 mm

Part number
3 39 01 118 01 0



PLASTIC BOX

Box insert with lockable lid for small parts and accessories, suitable for tool box 3 39 01 118 01 0, max 5 items/box.

Part number
3 39 01 119 00 0



TOOL CASE

Plastic, inner dimensions: 470 x 275 x 232 mm

Part number
3 39 01 122 01 0



MICROFIBRE CLOTH

Fine weave quality for cleaning polishing residue. Hem-free version means no scratches and no lint

Part number
6 37 33 003 01 0



STAINLESS STEEL MASKING TAPE

To protect stainless steel surfaces from scratches when sanding. Perfect for use with grinding of mitre joints on welded stainless steel profiles. The covered side is protected by masking tape when sanding, satin-finishing or matting.

L m	Part number
5	6 37 33 010 01 0

ACCESSORIES FOR RS 12-70 E



BASIC PIPE SANDER SET

Cleaning off dirt, removing scratches and achieving a perfect satin finish. Consisting of: 2 x 10 grinding belts, 20 x 815 mm, P 120/P180; 2 x 10 grinding belts, 40 x 815 mm, P120/P180; 5 fleece belts, 20 x 820 mm, very fine 280

Part number
6 37 14 050 02 1



CERAMIC SANDING BELTS

Maximum material removal and very long service life. Also suitable for removing fine welded seams

Grain	Dimensions mm	No. in pack pcs	Part number
80	20 x 815	10	6 37 14 130 01 0
80	40 x 815	10	6 37 14 131 01 0



GRINDING BELTS

Highly flexible sanding belts, ideal for sanding pipe bends
20 x 815 mm

Grain	No. in pack pcs	Part number
120	10	6 37 14 050 01 5
180	10	6 37 14 051 01 4
320	10	6 37 14 052 01 7
400	10	6 37 14 053 01 1



GRINDING BELTS

Highly flexible sanding belts, ideal for sanding pipe bends
40 x 815 mm

Grain	No. in pack pcs	Part number
120	10	6 37 14 054 01 9
180	10	6 37 14 055 01 3



FLEECE STRIPS

Very soft version for smooth surfaces, even with tight pipe bends
20 x 815 mm

Grain	No. in pack pcs	Part number
80	5	6 37 14 056 01 6
120	5	6 37 14 057 01 0
280	5	6 37 14 058 01 8



POLISHING BELTS

20 x 815 mm, very soft version, for smooth mirror polish even with tight pipe bends

Part number
6 37 26 010 01 8



ROTATING ROLLER

For narrow spaces (distance from wall 50 mm)

Part number
3 13 35 017 01 1

ACCESSORIES FOR BF 10-280 E



STEPPED GRINDING ARM

Belt width mm	Part number
3/6	6 38 10 026 01 0



STRAIGHT GRINDING ARM

Belt width mm	Part number
6	6 38 10 027 01 0
20	6 38 10 030 01 0



CERAMIC GRINDING BELT

Maximum material removal and very long service life. Also suitable for removing fine welded seams
Pack of 10, 520 mm long.

Grain	Width mm	Part number
80	3	6 37 14 061 01 0
120	3	6 37 14 062 01 0
180	3	6 37 14 063 01 0
80	6	6 37 14 068 01 0
120	6	6 37 14 069 01 0
180	6	6 37 14 070 01 0
80	20	6 37 14 089 01 0
120	20	6 37 14 090 01 0
180	20	6 37 14 091 01 0



FLEECE BELT
Soft version for smooth surfaces.
Pack of 5, 520 mm long.

Width mm	Model	Part number
6	coarse	6 37 14 114 01 0
6	medium	6 37 14 115 01 0
6	fine	6 37 14 116 01 0
20	coarse	6 37 14 123 01 0
20	medium	6 37 14 124 01 0
20	fine	6 37 14 125 01 0



POLISHING BELT
Soft version, for a smooth mirror polish in conjunction with FEIN polishing pastes.
Pack of 3, 520 mm long.

Width mm	Part number
6	6 37 26 016 01 0
20	6 37 26 019 01 0

ACCESSORIES FOR WSG 17-70 INOX



QUICK-CLAMPING NUT
M14, to change discs without need for tool, low height of just 8 mm

Part number
6 38 02 191 01 0



WORK GLOVES
Vibration-attenuating, certified according to EN 388/420, EN ISO 10819, EEC No. 0200, No. in pack 1 pair.

Size	Part number
9 L	3 21 73 003 00 3
10 XL	3 21 73 004 00 1
11 XXL	3 21 73 005 00 5



WHEEL GUARD
for serrated and roughing discs

Ø mm	Part number
125	3 18 10 300 00 0



SAFETY HOOD FOR CUTTING WORK
for safe working with cutting wheels

Ø mm	Part number
125	6 38 11 017 01 0



INNER FLANGE

Part number
6 38 01 182 01 0



THREADED FLANGE
M 14, for flexible grinding/cutting discs, fan-pattern grinding wheels and round brush

Part number
6 38 02 052 00 0



THREADED FLANGE
M 14, for elastic backing pad and for twisted steel wire brush

Part number
6 38 01 154 00 7



ELASTIC BACKING PAD
with flange M 14, for fibre sanding sheets Ø 125 mm

Ø mm	Part number
125	6 38 06 087 01 3



GRINDING DISC
For coarse sanding and machining a welded seam with a good service life. Can be used universally in steel and stainless steel. Stepped shape, inner diameter of 22.23 mm, maximum speed of 12 250 rpm, maximum working speed of 80 m/s.

Ø mm	Thickness mm	No. in pack pcs	Part number
125	6	10	6 37 03 005 01 0



CUTTING WHEEL
Perfect for dividing thin sheet metal, pipes and profiles. Precise and rapid cut with minimum effort and excellent service life. No rework or thermal discolouration on the workpiece. Can be used universally in steel and stainless steel. Straight shape, inner diameter of 22.23 mm, maximum speed of 12 250 rpm, maximum working speed of 80 m/s.

Ø mm	Thickness mm	No. in pack pcs	Part number
125	1	25	6 37 09 013 01 0



CUTTING WHEEL
For dividing sheet metal, pipes and profiles with good dividing speed and good service life. Can be used universally in steel and stainless steel. Stepped shape, inner diameter of 22.23 mm, maximum speed of 12 250 rpm, maximum working speed of 80 m/s.

Ø mm	Thickness mm	No. in pack pcs	Part number
125	2,5	25	6 37 09 014 01 0



FLAP WHEEL
Abrasive material made from zirconium corundum for excellent surface results with good sanding capacity, offering simple handling and few vibrations. Ideal for machining edges. Long service life with consistent quality of work. Can be used universally in steel and stainless steel. Conical shape, inner diameter of 22.23 mm, maximum speed of 12 250 rpm, maximum working speed of 80 m/s.

Grain	Ø mm	No. in pack pcs	Part number
40	125	10	6 37 30 022 01 0
60	125	10	6 37 30 023 01 0
80	125	10	6 37 30 024 01 0



FIBRE SANDING DISC
High-performance abrasive material made from zirconium corundum with a very good sanding capacity and service life. Can be used universally in steel and stainless steel.

Grain	Ø mm	No. in pack pcs	Part number
36	125	25	6 37 17 301 01 0
60	125	25	6 37 17 302 01 0
80	125	25	6 37 17 303 01 0

**BACKING PAD**

M 14, Ø 125 mm, with Velcro attachment, for sanding sheets with Velcro rapid attachment

Ø mm	Part number
115	6 38 06 168 01 2

**BACKING PAD**

with Velcro attachment, for working with sanding fleece, M 14

Ø mm	Part number
115	6 38 06 172 01 0

**FLEECE SANDING DISCS**

Ø 115 mm, with Velcro attachment, for use with support plate
6 38 06 172 01 0

Model	No. in pack pcs	Part number
coarse	10	6 37 32 001 01 8
medium	10	6 37 32 002 01 1
fine	10	6 37 32 003 01 5

**COOL SANDING PAD**

Rear-ventilated backing pad, ideal for Pyramix sanding discs

Ø mm	Part number
115	6 38 06 193 01 0

**COOL SANDING PAD**

Rear-ventilated backing pad, ideal for Pyramix sanding discs for use when the outer edge of the sanding discs has been removed.

Ø mm	Part number
75	6 38 06 196 01 0

**SANDING SHEETS**

Ø 115 mm, for removing very deep scratches and fine welded seams

Grain	No. in pack pcs	Part number
80	25	6 37 28 135 01 0

**PYRAMIX SANDING SHEET**

The Pyramix hook and loop sanding disc features a new perforation pattern which means it can now also be used after the first edge has been worn away. Ø 115 mm.
For removing deep scratches

Grain	No. in pack pcs	Part number
280	5	6 37 17 239 01 0
280	25	6 37 17 239 02 0

**PYRAMIX SANDING SHEET**

The Pyramix hook and loop sanding disc features a new perforation pattern which means it can now also be used after the first edge has been worn away. Ø 115 mm.
For removing minor scratches, creating sanding pattern, reducing roughness depth

Grain	No. in pack pcs	Part number
400	5	6 37 17 240 01 0
400	25	6 37 17 240 02 0

**PYRAMIX SANDING SHEET**

The Pyramix hook and loop sanding disc features a new perforation pattern which means it can now also be used after the first edge has been worn away. Ø 115 mm.
For removing very minor scratches, creating sanding pattern, reducing roughness depth

Grain	No. in pack pcs	Part number
800	5	6 37 17 241 01 0
800	25	6 37 17 241 02 0

**PYRAMIX SANDING SHEET**

The Pyramix hook and loop sanding disc features a new perforation pattern which means it can now also be used after the first edge has been worn away. Ø 115 mm.
Reducing roughness depth, optimum preconditions for subsequent polishing

Grain	No. in pack pcs	Part number
1 400	5	6 37 17 242 01 0
1 400	25	6 37 17 242 02 0

**FLAP WHEEL**

diameter 125 mm, M 14

Grain	Width mm	Part number
120	20	6 37 21 052 01 0

**FINISHING DISC**

Ø 125 mm, for final finish

Part number
6 37 32 005 01 0

**FLAP WHEEL**

Ideal for stainless steel processing and removing welded seams and finishing in one step. A combination of rapid material removal and perfect surface quality.

Ø mm	Model	No. in pack pcs	Part number
125	soft	5	6 37 30 019 01 0
125	medium	5	6 37 30 021 01 0
125	coarse	5	6 37 30 020 01 0

**STAINLESS STEEL SET – PREPARING TO POLISH SURFACES / PIPES / PROFILES**

Quickly and effectively removes scratches; optimum preparation for polishing with matched sanding pattern; when preparing for polishing: effective material removal in little time. Consisting of: 5 Pyramix sanding sheets, grit 280 (6 37 17 239 01 0), 5 Pyramix sanding sheets, grit 400 (6 37 17 240 01 0), 5 sanding sheets, grit 800 (6 37 17 241 01 0), 5 Pyramix sanding sheets, grit 1400 (6 37 17 242 01 0), 1 cooling backing pad, Ø 75 mm (6 38 06 196 01 0), 25 sanding sheets, grit 80 (6 37 28 135 01 0), 1 cooling backing pad, Ø 115 mm (6 38 06 193 01 0)

Part number
6 38 06 193 04 0

**FELT SERRATED DISC**

For polishing and pre-polishing stainless steel. Because of the lamella, the felt doesn't "burn" and polishing without streaks is possible. Only use with polishing paste (pre-polishing = pre-polishing paste, high-gloss polishing = colouring paste).

Ø mm	Model	Part number
125	soft	6 37 23 037 01 0
125	medium	6 37 23 038 01 0

ACCESSORIES FOR KS 10-38 E



FLEECE DISC

Very high sanding capacity for sanding, descaling and satin-finishing fillet welds.

Ø mm	Thickness mm	Model	Part number
150	7	very course	6 37 34 008 01 0



FLEECE DISC

With a high sanding capacity for sanding, descaling and satin-finishing fillet welds.

Ø mm	Thickness mm	Model	Part number
150	3	coarse	6 37 34 001 01 0
150	6	coarse	6 37 34 002 01 0



FLEECE DISC

For sanding, levelling, descaling and fine satin-finishing of fillet welds. Removes scratches on profiles and surfaces with ease.

Ø mm	Thickness mm	Model	Part number
150	3	medium	6 37 34 003 01 0
150	6	hard	6 37 34 004 01 0



FLEECE DISC

Removes tarnishing and minor scratches, ideal for preparing to polish fillet welds.

Ø mm	Thickness mm	Model	Part number
150	3	fine	6 37 34 005 01 0
150	6	fine	6 37 34 006 01 0



FLEECE DISC

For pre-polishing surfaces of fillet welds. Quickly removes tarnishing without wearing away the welded seam.

Ø mm	Thickness mm	Model	Part number
150	6	very fine	6 37 34 007 01 0



FELT DISC

For polishing fillet welds to a mirror polish in conjunction with FEIN polishing paste.

Ø mm	Thickness mm	Part number
150	6	6 37 18 011 01 0



PROFILING STONE

For sanding the fleece discs for even fillet weld profiles.

Part number
6 37 19 011 01 0

ACCESSORY RS 10-70 E



GRINDING BELTS

Highly flexible sanding belts, ideal for sanding pipe bends
No. in pack 10, 30 x 533 mm.

Grain	Part number
80	6 37 14 136 01 0
120	6 37 14 137 01 0
180	6 37 14 138 01 0
320	6 37 14 139 01 0
400	6 37 14 140 01 0



FLEECE STRIPS

Very soft version for smooth surfaces, even with tight pipe bends
No. in pack 5, 30 x 533 mm.

Model	Part number
fine	6 37 14 143 01 0



POLISHING BELTS

Very soft version for smooth mirror polish, even with tight pipe bends.
No. in pack 3, 30 x 533 mm.

Part number
6 37 14 144 01 0

ACCESSORIES FOR ROT 14-200 E



PROTECT.SUCTION HOOD

Part number
3 18 10 264 01 0

PROTECT.SUCTION HOOD

Part number
3 18 10 240 01 4



CONNECTING PIECE

Universal device to connect power tools and accessories with dust extraction to vacuum cleaner. Flexible rubber sleeve, length 70 mm, inner diameter 31.5 mm.

Part number
3 13 22 771 00 9



SANDING SHEETS

perforated, Ø 150 mm, with Velcro rapid attachment
Application: Wood, metal, car bodies, welds. Quality: fully synthetic-resin bonded, corundum. Features: high sanding capacity.

Grain	No. in pack pcs	Part number
60	50	6 37 28 022 01 7



SANDING PAD

Ø 150 mm, with holes, with hook and loop fastener

Model	Part number
hard	6 38 06 116 02 1
extra soft	6 38 06 166 02 6

**SANDING PAD**

Ø 200 mm, with holes, with hook and loop fastener

Model	Part number
hard	6 38 06 102 02 3
medium	6 38 06 095 02 1
extra soft	6 38 06 118 02 3

**LAMBSKIN**

with Velcro rapid attachment.

Ø mm	Part number
150	6 37 23 009 00 4
200	6 37 23 010 00 6

**ECCENTRIC HEAD**

Ø 150 mm

Part number
3 12 07 103 01 3

**SANDING SHEETS**

perforated, Ø 150 mm, with Velcro rapid attachment
 Application: Metal, car bodies, soldered points, welds, fibreglass. Quality: high-performance emery canvas, fully synthetic-resin bonded, corundum. Features: highly stable, high sanding capacity.

Grain	No. in pack pcs	Part number
40	50	6 37 28 009 01 4
60	50	6 37 28 010 01 6
80	50	6 37 28 056 01 3
100	50	6 37 28 054 01 6

ACCESSORIES FOR MSF 636-1**HOOK AND LOOP FASTENER**

Ø 150 mm

Ø mm	Part number
150	3 14 26 030 00 5

SANDING PAD

Ø 115 mm, without holes, with hook and loop fastener, hard

Part number
6 38 06 167 02 0

**SANDING SHEETS**

perforated, Ø 150 mm, for removing very deep scratches and fine welded seams

Grain	No. in pack pcs	Part number
80	50	6 37 28 096 01 9

**SANDING PAD**

Ø 125 mm, perforated, with hook and loop fastening

Connector thread backing pad	Model	Part number
5/16"-24 UNF	hard	6 38 06 103 02 7
5/16"-24 UNF	medium	6 38 06 088 02 7
5/16"-24 UNF	soft	6 38 06 117 02 5

**SANDING PAD**

Ø 150 mm, with holes, with hook and loop fastener

Connector thread backing pad	Model	Part number
5/16"-24 UNF	hard	6 38 06 101 02 0
5/16"-24 UNF	medium	6 38 06 090 02 3
5/16"-24 UNF	soft	6 38 06 114 02 4

**SANDING SHEETS**

perforated, Ø 150 mm, with Velcro rapid attachment
 Application: wood, paint, automotive paints, filler, fibreglass, plastics. Quality: fully synthetic-resin bonded, corundum. Feature: greatly reduces glazing, flexible.

Grain	No. in pack pcs	Part number
80	50	6 37 28 074 01 4
120	50	6 37 28 084 01 3
150	50	6 37 28 012 01 8
180	50	6 37 28 013 01 2
240	50	6 37 28 015 01 4

**SANDING SHEETS**

perforated, Ø 150 mm, with Velcro rapid attachment
 Application: Wood, metal, car bodies, welds. Quality: fully synthetic-resin bonded, light bond, corundum. Features: high sanding capacity.

Grain	No. in pack pcs	Part number
60	50	6 37 28 073 01 6

**LAMBSKIN**

with Velcro rapid attachment.

Ø mm	Part number
125	6 37 23 008 00 0
150	6 37 23 009 00 4

ACCESSORIES FOR WPO 14-25 E**STANDARD STAINLESS STEEL SET FOR SURFACES**

Set for standard applications in surface machining: cleaning off dirt with corrugated fleece, removing tarnishing and achieving a high-quality satin finish. Consisting of: 1 elastic sanding cylinder, grit 60 (6 37 21 006 01 2), 1 lamella fleece cylinder (6 37 21 009 01 8), 1 corrugated sanding fleece (6 37 23 021 01 3), 1 fine fleece sanding disc, pack of 10 (6 37 32 003 01 5), 1 support plate (6 38 06 172 01 0), 1 work arbour (6 38 03 066 02 4), 1 pin-type face spanner (6 29 10 022 00 2), 1 open-ended spanner 19 x 22 (6 29 04 003 00 0)

Part number
6 37 21 006 04 0



STAINLESS STEEL SET FOR GRINDING SURFACES
 Effective material removal for surfaces. Consisting of: 1 expansion cylinder (6 38 06 192 01 0), 5 sanding sleeves, grit 60 (6 37 14 132 01 0), 5 sanding sleeves, grit 80 (6 37 14 133 01 0), 5 sanding sleeves, grit 120 (6 37 14 134 01 0)

Part number
 6 38 06 192 02 0



STAINLESS STEEL SET FOR SATIN-FINISHING SURFACES
 Perfect smooth satin finish. Very low build-up of heat during machining. Consisting of: 1 medium elastic sanding cylinder, grit 60 (6 37 21 006 01 2), 1 fine elastic sanding cylinder, grit 180 (6 37 21 007 01 6), 1 fine sine fleece sanding cylinder, grit 180 (6 37 21 051 01 0)

Part number
 6 37 21 050 02 0



STANDARD STAINLESS STEEL SET FOR PIPES
 Set for standard applications in the machining of straight pipes. Cleaning off dirt, removing tarnishing and achieving a high-quality satin finish. Consisting of: 1 grinding belt roller (6 38 06 181 01 6), 1 grinding belt, grit 60, pack of 10 (6 37 14 044 01 0), 1 grinding belt, grit 120, pack of 10 (6 37 14 045 01 4), 1 medium fleece belt (6 37 14 048 01 9), 1 fine fleece belt (6 37 14 049 01 3), 1 adhesive strip (6 38 09 004 01 9)

Part number
 6 38 06 181 03 0



STAINLESS STEEL SET – SATIN-FINISHING PROFILES
 Satin-finishing of profiles for a perfect sanding pattern. Consisting of: 1 elastic cylinder, grit 60, medium (6 37 21 054 01 0), 1 elastic cylinder, grit 180, fine (6 37 21 055 01 0), 1 sine fleece sanding cylinder, fine (6 37 21 056 01 0), 1 work arbour (6 38 03 071 02 0)

Part number
 6 37 21 054 02 0



ELASTIC SANDING CYLINDER
 Bore 19 mm
 100 x 100 mm

Grain	Model	Part number
60	medium	6 37 21 006 01 2
180	fine	6 37 21 007 01 6



ELASTIC SANDING CYLINDER
 Bore 19 mm
 100 x 50 mm

Grain	Model	Part number
60	medium	6 37 21 054 01 0
180	fine	6 37 21 055 01 0



SINE FLEECE SANDING CYLINDER
 Bore 19 mm
 Ø 100 x 50 mm, with sine wave, for smooth satin finish

Grain	Model	Part number
180	fine	6 37 21 056 01 0



SINE FLEECE SANDING CYLINDER
 Bore 19 mm
 Ø 100 x 100 mm, with sine wave, for smooth satin finish

Grain	Model	Part number
180	fine	6 37 21 051 01 0



FLAP WHEEL
 diameter 150 mm, bore 14 mm
 For remedying minor mistakes and scratches

Part number
 6 37 21 003 01 7



FLAP WHEEL
 diameter 150 mm, bore 14 mm
 for medium brush applications

Part number
 6 37 21 004 01 5



FLAP WHEEL
 diameter 150 mm, bore 14 mm
 For for fine brush strokes, satin finish.

Part number
 6 37 21 005 01 9



LAMELLA FLEECE CYLINDER
 100 x 100 mm

Part number
 6 37 21 015 01 0



LAMELLA FLEECE CYLINDER
 diameter 100 x 100 mm, bore 19 mm
 For medium satin finish

Grain	Model	Part number
100	medium	6 37 21 008 01 4



LAMELLA FLEECE CYLINDER
 diameter 100 x 100 mm, bore 19 mm
 For fine satin finish

Grain	Model	Part number
180	fine	6 37 21 009 01 8



LAMELLA FLEECE CYLINDER
 diameter 100 x 100 mm, bore 19 mm
 For very fine satin finish

Grain	Model	Part number
280	very fine	6 37 21 010 01 0

**FELT LAMELLA ROLLER**

For polishing and pre-polishing stainless steel. Because of the lamella, the felt doesn't "burn" and polishing without streaks is possible. Only use with polishing paste (pre-polishing = pre-polishing paste, high-gloss polishing = colouring paste).

Model	Part number
soft	6 37 21 057 01 0
medium	6 37 21 058 01 0

**SANDING FLEECE**

with corrugated folds, width approx. 30 mm, bore hole 14 mm, for light finishing work, derusting, polishing, and decorative work

Ø mm	Part number
150	6 37 23 021 01 3
200	6 37 23 022 01 6

**FLEECE SANDING DISCS**

Ø 115 mm, with Velcro attachment, for use with support plate 6 38 06 172 01 0

Model	No. in pack pcs	Part number
coarse	10	6 37 32 001 01 8
medium	10	6 37 32 002 01 1
fine	10	6 37 32 003 01 5

**BACKING PAD**

with Velcro attachment, for working with sanding fleece, M 14

Ø mm	Part number
115	6 38 06 172 01 0

**SANDING STRIP ROLL**

Bore 19 mm
100 x 70 mm

Part number
6 38 06 181 01 6

**GRINDING BELTS**

600 x 30 mm

Grain	No. in pack pcs	Part number
60	10	6 37 14 044 01 0
120	10	6 37 14 045 01 4
240	10	6 37 14 046 01 7

ADHESIVE STRIP

For re-fastening grinding belts in closed pipe systems, 50 m

Part number
6 38 09 004 01 9

**FLEECE STRIPS**

With button closure for refastening, ideal for closed pipe systems, 600 x 30 mm

Model	Part number
coarse	6 37 14 047 01 1
medium	6 37 14 048 01 9
fine	6 37 14 049 01 3

**POLISHING RINGS, SISAL, CLOTH**

for

- fine finishing/brushing and levelling of non-ferrous metals following preliminary sanding with grain 240-280 using polishing paste "yellow".
- fine finishing/brushing and levelling of iron/steel, and stainless steel following preliminary sanding with grain 280-320 using polishing paste "yellow".
- matt-shining/brushing non-ferrous metals, iron/steel, and stainless steel using polishing paste "yellow".
- Preliminary polishing of iron/steel and stainless steel with preliminary polishing paste "orange" width about 30 mm, 14 mm bore

Ø mm	Part number
150	6 37 23 011 01 4
200	6 37 23 012 01 7

**POLISHING RINGS, HARD CLOTH**

Width approx. 15 mm, bore hole 14 mm, for preliminary polishing and polishing of non-ferrous metals, iron/steel, stainless steel with preliminary polishing paste "orange"

Ø mm	Part number
150	6 37 23 013 01 1
200	6 37 23 015 01 3

**POLISHING RINGS, SOFT CLOTH**

Width approx. 15 mm, bore hole 14 mm, for high-gloss polishing of non-ferrous metals, iron/steel, stainless steel and chrome with final polishing paste "white"

Ø mm	Part number
150	6 37 23 014 01 9
200	6 37 23 016 01 6

POLISHING RINGS, FLEECE, EXTRA SOFT

Width approx. 15 mm, bore hole 14 mm, for final polishing of non-ferrous metals, iron/steel, stainless steel and many plastics with final polishing paste "white"

Ø mm	Part number
150	6 37 23 019 01 2
200	6 37 23 020 01 4

**POLISHING WHEEL**

diameter 150 mm, width 60 mm, elastic, bore 14 mm for brush polishing, grain 16 (coarse), soft, "green"

Part number
6 37 13 013 01 8

**POLISHING WHEEL**

diameter 150 mm, width 60 mm, elastic, bore 14 mm for delicate surfaces, grit 24 (medium), soft, "blue"

Part number
6 37 13 015 01 0

POLISHING WHEEL

diameter 150 mm, width 60 mm, elastic, bore 14 mm for fine polishing, grit 46, soft, "brown"

Part number
6 37 13 016 01 3

**FLAP WHEEL**

Width 50 mm, for polishing rust-resistant steel, bore 14 mm

Ø mm	Part number
200	6 37 21 001 00 1



HOLDER
for side handle, 360° rotatable

Part number	
6 37 33 006 01 0	



WHEEL ARBOR
For satin-finishing tools (cylinders and rollers), tool holder
Ø 19 mm

Length mm	Part number
50	6 38 03 071 02 0
100	6 38 03 067 02 8



WHEEL ARBOR
with clamping flange M 14, for polishing rings, clamping range
15-35 mm

Part number	
6 38 03 027 03 8	



WHEEL ARBOR
With wheel flange M 14, for lamella sanding discs, buffing and
polishing discs, holding range 15 – 50 mm, tool mounting
diameter 14 mm

Part number	
6 38 03 066 02 4	



SAFETY GUARD
as hand guard

Part number	
3 02 29 216 00 5	



EXPANSION ROLLER
Bore 19 mm
Ø 100 x 100 mm, for vibration-free, secure holding of sanding
sleeves

Part number	
6 38 06 192 01 0	



SANDING SLEEVE
For removing small welded seams and very deep scratches
and mill scale

Grain	No. in pack pcs	Part number
60	5	6 37 14 132 01 0



SANDING SLEEVE
For removing deep scratches

Grain	No. in pack pcs	Part number
80	5	6 37 14 133 01 0



SANDING SLEEVE
For removing scratches, stage prior to satin-finishing

Grain	No. in pack pcs	Part number
120	5	6 37 14 134 01 0



PYRAMIX SANDING SLEEVE
For removing scratches, stage prior to satin-finishing

Grain	No. in pack pcs	Part number
280	5	6 37 14 145 01 0
400	5	6 37 14 146 01 0
600	5	6 37 14 147 01 0
1 400	5	6 37 14 148 01 0



WPO 14-15 E	WPO 14-15 E SET	WPO 14-15 E MARINE POLISHING SET	WPO 14-15 E MARINE POLISHING SET	WPO 14-25 E	WPO 10-25 E	WPO 10-25 E SET
--------------------	------------------------	-----------------------------------------	-----------------------------------------	--------------------	--------------------	------------------------

Extremely powerful angle polisher for vehicle and boat repairs.	Polishing set for boat repairs.	Extremely powerful angle polisher for refurbishing paintwork.	Powerful easy-to-use angle polisher for refurbishing paintwork.
-----------------------------------------------------------------	---------------------------------	---------------------------------------------------------------	-----------------------------------------------------------------

PAGE		212	212	212	213	213	214	214
Polishing		++	++	++	++	++	++	++
Rough sanding		+	+	++	++	++		
Fine sanding		+	+	++	++	++		
Dry sanding		++	++	++	++	++		
Micro-sanding		++	++	++	++	++		
Soft start		•	•	•	•	•	•	•
Restart protection		•	•	•	•	•	•	•
FEIN high-power motor		•	•	•	•	•	•	•
Spindle lock		•	•	•	•	•	•	•
Input	W	1 200	1 200	1 200	1 200	1 200	800	800
Output	W	750	750	750	750	750	550	550
Speed, no load	rpm	500 - 1,500	500 - 1,500	500 - 1,500	500 - 1,500	900 - 2,500	900 - 2,500	900 - 2,500
Polishing disc Ø	mm	230	230	230	230	230	150	150
Mounting thread		M 14	M 14	M 14	M 14	M 14	M 14	M 14
Cable with plug	m	4	4	4	4	4	4	4
Weight according to EPTA	kg	2,5	2,5	2,5	2,5	2,5	2,2	2,2

+ suitability ++ optimal suitability • included

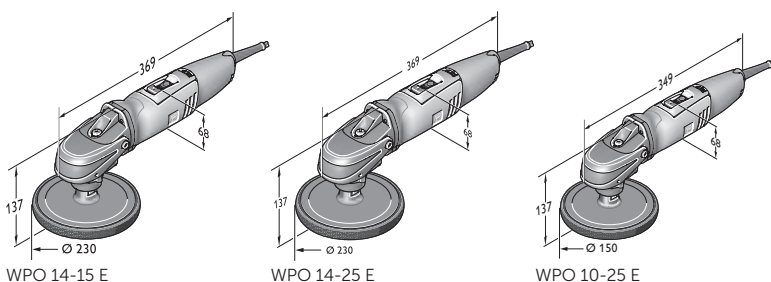

WPO 14-15 E**SUPPLIED**

1 Grip hood, 1 additional handle

For accessories, see page 215

Extremely powerful angle polisher for vehicle and boat repairs.

Input	W	1 200
Output	W	750
Speed, no load	rpm	500 - 1,500
Polishing disc Ø	mm	230
Mounting thread		M 14
Cable with plug	m	4
Weight according to EPTA	kg	2,5

Part number	7 221 48 00 23 0
EAN	4014586862699

FEIN BENEFITS

- + Ideal speed range with infinitely variable speed control for professional surface processing on vehicles and boats.
- + Maximum speed stability at any load over the full setting range thanks to mechanical gear reduction in conjunction with the FEIN high-power motor.
- + Special system accessories for the efficient refurbishment of used car paintwork, new car paintwork and highly scratch-resistant paints, and for cleaning, sanding and polishing boat surfaces and gelcoat layers.
- + Convenient speed adjustment.
- + Does not heat up in continuous use.
- + Handle cover for excellent ergonomics.
- + Spindle lock.
- + Right or left-handed operation.
- + Restart protection.
- + Soft start.
- + Carbon brushes with self cut-off function.
- + Can be converted to rotary sander with extractor hood and backing pad.

WPO 14-15 E SET**SUPPLIED**

1 anti-vibration handle, 1 Grip hood,
1 Support plate with Velcro attachment,
Ø 150 mm, 1 Polishing sponge,
Ø 150 mm, medium

For accessories, see page 215

Extremely powerful angle polisher for vehicle and boat repairs.

Input	W	1 200
Output	W	750
Speed, no load	rpm	500 - 1,500
Polishing disc Ø	mm	230
Mounting thread		M 14
Cable with plug	m	4
Weight according to EPTA	kg	2,5

Part number	7 221 48 51 01 0
EAN	4014586867069

FEIN BENEFITS

- + Ideal speed range with infinitely variable speed control for professional surface processing on vehicles and boats.
- + Maximum speed stability at any load over the full setting range thanks to mechanical gear reduction in conjunction with the FEIN high-power motor.
- + Special system accessories for the efficient refurbishment of used car paintwork, new car paintwork and highly scratch-resistant paints, and for cleaning, sanding and polishing boat surfaces and gelcoat layers.
- + Convenient speed adjustment.
- + Does not heat up in continuous use.
- + Handle cover for excellent ergonomics.
- + Spindle lock.
- + Right or left-handed operation.
- + Restart protection.
- + Soft start.
- + Carbon brushes with self cut-off function.
- + Can be converted to rotary sander with extractor hood and backing pad.
- + Tool also available without accessories (7 221 48).

WPO 14-15 E MARINE POLISHING SET**SUPPLIED**

1 anti-vibration handle, 1 Grip hood,
1 support plate with hook and loop
fastening, Ø 170 mm, 1 polishing pad,
Ø 195 mm, 1 plastic carrying case

For accessories, see page 215

Polishing set for boat repairs.

Input	W	1 200
Output	W	750
Speed, no load	rpm	500 - 1,500
Polishing disc Ø	mm	230
Mounting thread		M 14
Cable with plug	m	4
Weight according to EPTA	kg	2,5

Part number	7 221 48 60 00 0
EAN	4014586872216

FEIN BENEFITS

- + Ideal speed range with infinitely variable speed control for professional surface machining on boats.
- + Maximum speed stability at any load over the full setting range thanks to mechanical gear reduction in conjunction with the FEIN high-power motor.
- + Special system accessories for the efficient refurbishment of used car paintwork, new car paintwork and highly scratch-resistant paints, and for cleaning, sanding and polishing boat surfaces and gelcoat layers.
- + Convenient speed adjustment.
- + Does not heat up in continuous use.
- + Handle cover for excellent ergonomics.
- + Spindle lock.
- + Right or left-handed operation.
- + Restart protection.
- + Soft start.
- + Carbon brushes with self cut-off function.
- + Can be converted to rotary sander with extractor hood and backing pad.
- + Wide range of accessories.
- + Tool also available without accessories (7 221 48).

WPO 14-15 E MARINE POLISHING SET



SUPPLIED

1 anti-vibration handle, 1 Grip hood, 1 support plate with hook and loop fastening, Ø 170 mm, 1 polishing pad, Ø 195 mm, 1 lamb's wool, dome shape, Ø 235 mm, 1 Extractor hood, 1 sanding pad Ø 150 mm, 2 sanding fleeces for antifouling, 1 bristle fleece, 2 of each sanding sheet, Ø 150 mm, perforated, (G 80, 150, 180), 1 plastic carrying case

For accessories, see page 215

Polishing set for boat repairs.

Input	W	1 200
Output	W	750
Speed, no load	rpm	500 - 1,500
Polishing disc Ø	mm	230
Mounting thread		M 14
Cable with plug	m	4
Weight according to EPTA	kg	2,5

Part number	7 221 48 50 01 0
EAN	4014586862712

FEIN BENEFITS

- + Ideal speed range with infinitely variable speed control for professional surface machining on boats.
- + Maximum speed stability at any load over the full setting range thanks to mechanical gear reduction in conjunction with the FEIN high-power motor.
- + Special system accessories for the efficient refurbishment of used car paintwork, new car paintwork and highly scratch-resistant paints, and for cleaning, sanding and polishing boat surfaces and gelcoat layers.
- + Convenient speed adjustment.
- + Does not heat up in continuous use.
- + Handle cover for excellent ergonomics.
- + Spindle lock.
- + Right or left-handed operation.
- + Restart protection.
- + Soft start.
- + Carbon brushes with self cut-off function.
- + Can be converted to rotary sander with extractor hood and backing pad.
- + Wide range of accessories.
- + Tool also available without accessories (7 221 48).

WPO 14-25 E



SUPPLIED

1 anti-vibration handle, 1 Grip hood, 1 Support plate with Velcro attachment, Ø 150 mm, 1 Polishing sponge, Ø 150 mm, medium

For accessories, see page 215

Extremely powerful angle polisher for refurbishing paintwork.

Input	W	1 200
Output	W	750
Speed, no load	rpm	900 - 2,500
Polishing disc Ø	mm	230
Mounting thread		M 14
Cable with plug	m	4
Weight according to EPTA	kg	2,5

Part number	7 221 49 51 01 0
EAN	4014586867113

FEIN BENEFITS

- + Ideal speed range with infinitely variable speed control for professional surface processing on vehicles and boats.
- + Special system accessories for the efficient refurbishment of used car paintwork, new car paintwork and highly scratch-resistant paints, and for cleaning, sanding and polishing boat surfaces and gelcoat layers.
- + Maximum speed stability at any load over the full setting range thanks to mechanical gear reduction in conjunction with the FEIN high-power motor.
- + Excellent handling.
- + Spindle lock.
- + Right or left-handed operation.
- + Restart protection.
- + Soft start.
- + H 07 industrial cable.
- + Dustproof ball bearing.
- + Carbon brushes with self cut-off function.
- + Comprehensive range of accessories available.
- + Tool also available without accessories (7 221 49).

WPO 10-25 E**SUPPLIED**

1 additional handle, 1 Grip hood

For accessories, see page 215

Powerful easy-to-use angle polisher for refurbishing paintwork.

Input	W	800
Output	W	550
Speed, no load	rpm	900 - 2,500
Polishing disc Ø	mm	150
Mounting thread		M 14
Cable with plug	m	4
Weight according to EPTA	kg	2,2

Part number	7 221 63 00 23 0
EAN	4014586866055

FEIN BENEFITS

- + Ideal speed range with infinitely variable speed control for professional surface machining on vehicles.
- + Maximum speed stability at any load over the full setting range thanks to mechanical gear reduction in conjunction with the FEIN high-power motor.
- + Special system accessories for effective refurbishing of new and used cars and highly scratch-resistant paintwork.
- + Convenient speed adjustment.
- + Does not heat up in continuous use.
- + Handle cover for excellent ergonomics.
- + Spindle lock.
- + Right or left-handed operation.
- + Restart protection.
- + Soft start.
- + Carbon brushes with self cut-off function.

WPO 10-25 E SET**SUPPLIED**

1 anti-vibration handle, 1 Grip hood,
1 Support plate with Velcro attachment, Ø 150 mm, 1 Polishing sponge, Ø 150 mm, medium

For accessories, see page 215

Powerful easy-to-use angle polisher for refurbishing paintwork.

Input	W	800
Output	W	550
Speed, no load	rpm	900 - 2,500
Polishing disc Ø	mm	150
Mounting thread		M 14
Cable with plug	m	4
Weight according to EPTA	kg	2,2

Part number	7 221 63 51 01 0
EAN	4014586867199

FEIN BENEFITS

- + Ideal speed range with infinitely variable speed control for professional surface machining on vehicles.
- + Maximum speed stability at any load over the full setting range thanks to mechanical gear reduction in conjunction with the FEIN high-power motor.
- + Special system accessories for effective refurbishing of new and used cars and highly scratch-resistant paintwork.
- + Convenient speed adjustment.
- + Does not heat up in continuous use.
- + Handle cover for excellent ergonomics.
- + Spindle lock.
- + Right or left-handed operation.
- + Restart protection.
- + Soft start.
- + Carbon brushes with self cut-off function.
- + Tool also available without accessories (7 221 63).

GENERAL ACCESSORIES



TOOL CASE

Plastic, inner dimensions: 470 x 275 x 232 mm

Part number
3 39 01 122 01 0

ACCESSORIES FOR WPO 10-25 E, WPO 14-15 E, WPO 14-15 XE, WPO 14-25 E



MICROFIBRE CLOTH

Fine weave quality for cleaning polishing residue. Hem-free version means no scratches and no lint

Part number
6 37 33 003 01 0



SANDING DISC

Micro-fine self-adhesive sandpaper, 2800 grain, for treating lacquer faults such as lacquer inclusions. 1 sheet of 53 sanding discs, Ø 30 mm. Fits on hand sanding block 6 37 33 002 01 0

Part number
6 37 17 221 01 0



HUMIDIFICATION SPONGE

Easy-to-use foam cube for hygienic moisturizing the sanding discs.

Part number
6 37 33 001 01 0



SANDING BLOCK

Easy-to-use sanding block for holding self-adhesive sanding discs on both sides.

Part number
6 37 33 002 01 0



BACKING PAD

with Velcro attachment, M 14

Ø mm	Part number
80	6 38 06 179 01 5
125	6 38 06 169 01 6
130	6 38 06 178 01 1
150	6 38 06 170 01 8



BACKING PAD

for lamb's fleece with tensioning cord, rubber coated, M 14

Ø mm	Part number
120	6 38 06 012 00 8



POLISHING SPONGE

For polishing painted surfaces. Various hardness grades: soft for new paintwork, medium for slightly weathered paintwork and applying wax, hard for severely weathered paintwork. Quick hook and loop fastening, height 40 mm.

Ø mm	Model	Part number
100	soft	6 37 23 024 01 8
100	hard	6 37 23 023 01 0
125	medium	6 37 23 017 01 0
150	medium	6 37 23 018 01 8



POLISHING SPONGE ORANGE 150 MM

Polishing sponge with fine pores, medium hard for new and old lacquers Ø 150 mm

Part number
6 37 23 028 01 0



WAFFLED SPONGE

Extremely fine and soft polishing sponge for removing holograms on dark lacquers. Ø 150 mm

Part number
6 37 23 029 01 0



LAMBSKIN

with tensioning cord

Ø mm	Part number
120	6 37 23 007 00 2



LAMBSKIN

with Velcro rapid attachment.

Ø mm	Part number
125	6 37 23 008 00 0
150	6 37 23 009 00 4

ACCESSORIES FOR WPO 14-15 E



BACKING PAD

with Velcro attachment, M 14

Ø mm	Part number
170	6 38 06 187 01 0



POLISHING SPONGE

Ø 195 mm for backing pads with a Ø of 170 mm, 6 38 06 187 01 0, M 14 with hook and loop fastening system. Recommended working speed 500-1 000 rpm.

Ø mm	Part number
195	6 37 23 034 01 0



BRISTLE FLEECE

Bristle fleece for cleaning or polishing boat hulls and decks, with a Ø of 195 mm for backing pads with a Ø of 170 mm, 6 38 06 187 01 0, M 14 with hook and loop fastening system. For fibreglass anti-slip structures. Recommended working speed: approx. 500 rpm.

Ø mm	Part number
195	6 37 23 033 01 0



LAMB'S WOOL, DOME SHAPE

Diameter approx. 230 mm for backing pads with a Ø of 170 mm, 6 38 06 187 01 0, M 14 with hook and loop fastening system. Recommended working speed 500-1,200 rpm. Quality TOPWOOL, fleece polishing wheel. Lamb's wool/synthetic blend, washable.

Ø mm	Part number
230	6 37 23 035 01 0



SANDING PAD

With hook and loop fastening, Ø 150 mm with M 14 suction hole. Hole circle suitable for FEIN and other sanding materials.

Ø mm	Part number
150	6 38 06 188 01 0



SANDING SHEETS

perforated, Ø 150 mm, with Velcro rapid attachment Application: Metal, car bodies, soldered points, welds, fibreglass. Quality: high-performance emery canvas, fully synthetic-resin bonded, corundum. Features: highly stable, high sanding capacity.

Grain	No. in pack pcs	Part number
60	50	6 37 28 010 01 6



SANDING SHEETS

perforated, Ø 150 mm, with Velcro rapid attachment Application: wood, paint, automotive paints, filler, fibreglass, plastics. Quality: fully synthetic-resin bonded, corundum. Feature: greatly reduces glazing, flexible.

Grain	No. in pack pcs	Part number
80	50	6 37 28 074 01 4
120	50	6 37 28 084 01 3
150	50	6 37 28 012 01 8
180	50	6 37 28 013 01 2
240	50	6 37 28 015 01 4



SANDING FLEECE FOR ANTIFOUL

Sanding fleece for light sanding and sanding down of coats of antifoul product. Produces a stunning sanding pattern without choking the sanding fleece. Very long service life.

Ø mm	No. in pack pcs	Part number
150	5	6 37 32 004 01 0



PROTECT.SUCTION HOOD

Part number
3 18 10 264 01 0



CONNECTING PIECE

Universal device to connect power tools and accessories with dust extraction to vacuum cleaner. Flexible rubber sleeve, length 70 mm, inner diameter 31.5 mm.

Part number
3 13 22 771 00 9

ACCESSORIES FOR WPO 10-25 E, WPO 14-15 E



TOOL CASE

Plastic, inner dimensions: 470 x 275 x 116 mm

Part number
3 39 01 118 01 0

ACCESSORIES FOR WPO 14-15 E, WPO 14-25 E



NYLON BARREL BRUSH

Ø 125 mm, grain 46, M 14, for brushing after removal by caustics, cleaning roof beams, restoration of antique furniture, roughing paint for new coats, deburring, and light derusting of metal parts

Part number
6 37 22 048 01 4

ACCESSORIES FOR WPO 14-15 E, WPO 14-15 XE



BACKING PAD

with Velcro attachment, M 14

Ø mm	Part number
200	6 38 06 171 01 7



BACKING PAD

for lamb's fleece with tensioning cord, rubber coated, M 14

Ø mm	Part number
170	6 38 06 030 00 4



POLISHING SPONGE

For polishing painted surfaces. Various hardness grades: soft for new paintwork, medium for slightly weathered paintwork and applying wax, hard for severely weathered paintwork. Quick hook and loop fastening, height 40 mm.

Ø mm	Model	Part number
160	soft	6 37 23 026 01 5
160	hard	6 37 23 025 01 2



LAMBSKIN

with tensioning cord

Ø mm	Part number
170	6 37 23 003 00 3



LAMBSKIN

with Velcro rapid attachment.

Ø mm	Part number
200	6 37 23 010 00 6



Skil LOCK PLUS

Skil MULTIMASTER 500

OSCILLATING MULTI-TOOL

MULTIMASTER **220**

The universal system for interior work and renovation.

STARLOCK ACCESSORIES **227**

12-SIDED FITTING ACCESSORIES **241**

MULTIMASTER AUTOMOTIVE **246**

The most powerful system for vehicle repairs.



	CORDLESS MULTIMASTER AMM 300 PLUS SELECT	CORDLESS MULTIMASTER AMM 300 PLUS START	MULTIMASTER MM 300 PLUS START	CORDLESS MULTIMASTER AMM 500 PLUS SELECT	CORDLESS MULTIMASTER AMM 500 PLUS TOP
	The effective cordless MultiTool for interior work and renovation in the variant without battery or charger – with a bimetal saw blade for wood, metal and plastics.	The effective cordless MultiTool for interior work and renovation with basic accessories for sawing in wood, metal, plasterboard and plastics.	The effective MultiTool for interior work and renovation with basic accessories for sawing in wood, metal, plasterboard and plastics.	The powerful cordless MultiTool for rapid work progress (in interior work and renovation) in the variant without battery or charger – with a bimetal saw blade for wood, metal and plastics.	The powerful cordless MultiTool for rapid work progress (in interior work and renovation) with more than 30 accessories – for sawing in wood and metal, sanding, removing tiles and much more.

PAGE		222	222	222	223	223
Mechanical interface					•	•
Input	W			250		
Battery voltage	V	12	12		18	18
Battery compatibility		Li-ion	Li-ion		Li-ion/ HighPower Li-ion	Li-ion/ HighPower Li-ion
Battery interface		12 V	12 V		18 V	18 V
Oscillations	rpm	11,500 - 18,000	11,500 - 18,000	11,000 - 20,000	11,000 - 18,500	11,000 - 18,500
Tool Holder		StarlockPlus	StarlockPlus	StarlockPlus	StarlockPlus	StarlockPlus
Tool change		QuickIN	QuickIN	QuickIN	QuickIN	QuickIN
Amplitude		2 x 1,6°	2 x 1,6°	2 x 1,6°	2 x 1,7°	2 x 1,7°
Weight according to EPTA	kg			1,4		
Weight with battery	kg		1,5			1,8
Weight without storage battery	kg	1,2	1,2		1,3	1,3

• included

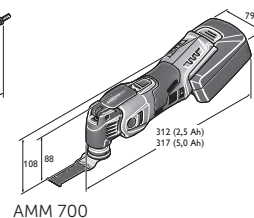
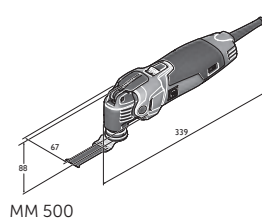
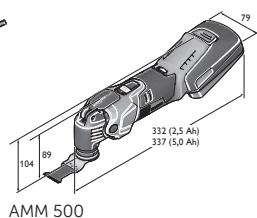
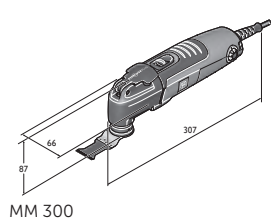
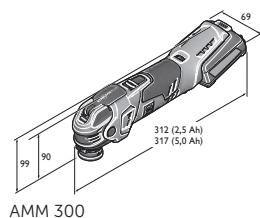



MULTIMASTER MM 500 PLUS	MULTIMASTER MM 500 PLUS TOP	CORDLESS MULTIMASTER AMM 700 MAX SELECT	CORDLESS MULTIMASTER AMM 700 MAX TOP	MULTIMASTER MM 700 MAX	MULTIMASTER MM 700 MAX TOP
The powerful MultiTool for rapid work progress (in interior work and renovation) with a bimetal saw blade for wood, metal and plastics.	The powerful MultiTool for rapid work progress (in interior work and renovation) with more than 30 accessories for sawing in wood and metal, sanding, removing tiles and much more.	Our best cordless MultiTool for the most rapid work progress in interior work and renovation in the variant without battery or charger – with a bimetal saw blade for wood, metal and plastics.	Our best MultiTool for the most rapid work progress in interior work and renovation with 60 accessories – from sawing in wood, metal and plastics, to cutting out tiles, cutting silicone joints and carpets, removing adhesive residues and tile adhesive.	Our best MultiTool for the most rapid work progress in interior work and renovation with a bimetal saw blade for wood, metal and plastics.	Our best MultiTool for the most rapid work progress in interior work and renovation with 60 accessories – from sawing in wood, metal and plastics, to cutting out tiles, cutting silicone joints and carpets, removing adhesive residues and tile adhesive.
224	224	225	225	226	226
•	•	•	•	•	•
350	350			450	450
		18	18		
		Li-ion/ HighPower Li-ion MultiVolt	Li-ion/ HighPower Li-ion MultiVolt		
10,000 - 19,500	10,000 - 19,500	10,000 - 19,500	10,000 - 19,500	10,000 - 19,500	10,000 - 19,500
StarlockPlus	StarlockPlus	StarlockMax	StarlockMax	StarlockMax	StarlockMax
QuickIN	QuickIN	QuickIN	QuickIN	QuickIN	QuickIN
2 x 1,7°	2 x 1,7°	2 x 2,0°	2 x 2,0°	2 x 2,0°	2 x 2,0°
1,4	1,4			1,6	1,6
			1,6		
		1,1	1,1		

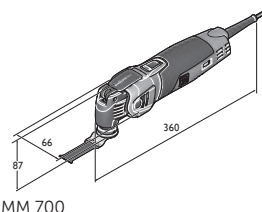

MM 700

CORDLESS MULTIMASTER AMM 300 PLUS SELECT



SUPPLIED

1 Universal E-Cut saw blade (44 mm),
1 plastic carrying case

For accessories, see page 228

The effective cordless MultiTool for interior work and renovation in the variant without battery or charger – with a bimetal saw blade for wood, metal and plastics.

Battery voltage	V	12
Battery compatibility		Li-ion
Battery interface		12 V
Oscillations	rpm	11,500 - 18,000
Tool Holder		StarlockPlus
Tool change		QuickIN
Amplitude		2 x 1,6°
Weight without storage battery	kg	1,2

Part number	7 129 32 62 00 0
EAN	4014586893013

FEIN BENEFITS

- + Anti-vibration system: continuously safe and pleasant working thanks to minimal vibrations and outstanding noise insulation.
- + StarlockPlus tool mounting: more work progress and greater precision thanks to 100 % power transmission without losses.
- + QuickIN: tool changes in less than 3 seconds thanks to the patented tool-free FEIN rapid clamping system.
- + With the StarlockPlus tool mounting, you can access around 100 FEIN accessories from the Starlock and StarlockPlus performance classes.
- + DC motor: effective and powerful motor technology offering virtually the same power as the mains-powered version.
- + Infinitely variable electronic speed setting.
- + Metal gearbox: ability to withstand high loading and outstanding service life because all the gearbox parts are made from metal.
- + SafetyCell technology: perfect protection against overload, overheating and total discharge thanks to Li-ion batteries with individual cell monitoring.
- + The battery charge can be read off the battery.

CORDLESS MULTIMASTER AMM 300 PLUS START



SUPPLIED

1 E-Cut long-life saw blade (35 mm),
1 E-Cut long-life saw blade (65 mm),
1 Universal E-Cut saw blade (44 mm),
1 rapid charger ALG 80, 2 Li-ion
battery packs (12 V / 3 Ah),
1 plastic carrying case

For accessories, see page 228

The effective cordless MultiTool for interior work and renovation with basic accessories for sawing in wood, metal, plasterboard and plastics.

Battery voltage	V	12
Battery capacity	Ah	3
Battery compatibility		Li-ion
Battery interface		12 V
Oscillations	rpm	11,500 - 18,000
Tool Holder		StarlockPlus
Tool change		QuickIN
Amplitude		2 x 1,6°
Weight with battery	kg	1,5
Weight without storage battery	kg	1,2

Part number	7 129 32 61 00 0
EAN	4014586892955

FEIN BENEFITS

- + Anti-vibration system: continuously safe and pleasant working thanks to minimal vibrations and outstanding noise insulation.
- + StarlockPlus tool mounting: more work progress and greater precision thanks to 100 % power transmission without losses.
- + QuickIN: tool changes in less than 3 seconds thanks to the patented tool-free FEIN rapid clamping system.
- + With the StarlockPlus tool mounting, you can access around 100 FEIN accessories from the Starlock and StarlockPlus performance classes.
- + DC motor: effective and powerful motor technology offering virtually the same power as the mains-powered version.
- + Infinitely variable electronic speed setting.
- + Metal gearbox: ability to withstand high loading and outstanding service life because all the gearbox parts are made from metal.
- + SafetyCell technology: perfect protection against overload, overheating and total discharge thanks to Li-ion batteries with individual cell monitoring.
- + The battery charge can be read off the battery.

MULTIMASTER MM 300 PLUS START



SUPPLIED

1 E-Cut long-life saw blade (35 mm),
1 E-Cut long-life saw blade (65 mm),
1 Universal E-Cut saw blade (44 mm),
1 plastic carrying case

For accessories, see page 228

The effective MultiTool for interior work and renovation with basic accessories for sawing in wood, metal, plasterboard and plastics.

Input	W	250
Oscillations	rpm	11,000 - 20,000
Tool Holder		StarlockPlus
Tool change		QuickIN
Amplitude		2 x 1,6°
Cable with plug	m	5
Weight according to EPTA	kg	1,4

Part number	7 229 72 61 00 0
EAN	4014586893747

FEIN BENEFITS

- + StarlockPlus tool mounting: more work progress and greater precision thanks to 100 % power transmission without losses.
- + QuickIN: tool changes in less than 3 seconds thanks to the patented tool-free FEIN rapid clamping system.
- + With the StarlockPlus tool mounting, you can access around 100 FEIN accessories from the Starlock and StarlockPlus performance classes.
- + 250 W FEIN motor: motor with a high copper content, which is suited to overload for more power and effective working.
- + Infinitely variable electronic speed setting.
- + Metal gearbox: ability to withstand high loading and outstanding service life because all the gearbox parts are made from metal.
- + Barrel-type design for maximum stability.
- + Industrial cable: large working radius thanks to finely stranded 5 metre rubber cable of industrial quality.

CORDLESS MULTIMASTER AMM 500 PLUS SELECT



SUPPLIED

1 Universal E-Cut saw blade (44 mm),
1 plastic carrying case

For accessories, see page 228

The powerful cordless MultiTool for rapid work progress (in interior work and renovation) in the variant without battery or charger – with a bimetal saw blade for wood, metal and plastics.

Battery voltage	V	18
Battery compatibility		Li-ion/ HighPower Li-ion
Battery interface		18 V
Oscillations	rpm	11,000 - 18,500
Tool Holder		StarlockPlus
Tool change		QuickIN
Amplitude		2 x 1,7°
Weight without storage battery	kg	1,3

Part number	7 129 33 62 00 0
EAN	4014586893099

FEIN BENEFITS

- + Anti-vibration system: continuously safe and pleasant working thanks to minimal vibrations and outstanding noise insulation.
- + StarlockPlus tool mounting: more work progress and greater precision thanks to 100 % power transmission without losses.
- + QuickIN: tool changes in less than 3 seconds thanks to the patented tool-free FEIN rapid clamping system.
- + With the StarlockPlus tool mounting, you can access around 100 FEIN accessories from the Starlock and StarlockPlus performance classes.
- + DC motor: effective and powerful motor technology offering virtually the same power as the mains-powered version.
- + Tacho generator: constant speeds even under load and infinitely variable electronic speed control.
- + Metal gearbox: ability to withstand high loading and outstanding service life because all the gearbox parts are made from metal.
- + Mechanical interface: for stationary operation in the table or drill jig holder or for securing the depth stop.
- + SafetyCell technology: perfect protection against overload, overheating and total discharge thanks to Li-ion batteries with individual cell monitoring.
- + The battery charge can be read off the battery.

CORDLESS MULTIMASTER AMM 500 PLUS TOP



SUPPLIED

1 E-Cut long-life saw blade (10 mm),
2 E-Cut long-life saw blades (35 mm),
2 E-Cut long-life saw blades (65 mm),
1 E-Cut carbide Pro saw blade (32 mm),
1 carbide saw blade (diameter 75 mm),
1 HM rasp (triangular),
1 Stopper knife, 1 Sanding plate with holes, with 5 sanding sheets, with holes for each of grit sizes 60, 80, 120, 180, 1 dust extraction device,
1 rapid charger ALG 80, 2 Li-ion battery packs (18 V / 3 Ah),
1 plastic carrying case

For accessories, see page 228

The powerful cordless MultiTool for rapid work progress (in interior work and renovation) with more than 30 accessories – for sawing in wood and metal, sanding, removing tiles and much more.

Battery voltage	V	18
Battery capacity	Ah	3
Battery compatibility		Li-ion/ HighPower Li-ion
Battery interface		18 V
Oscillations	rpm	11,000 - 18,500
Tool Holder		StarlockPlus
Tool change		QuickIN
Amplitude		2 x 1,7°
Weight with battery	kg	1,8
Weight without storage battery	kg	1,3

Part number	7 129 33 61 00 0
EAN	4014586893037

FEIN BENEFITS

- + Anti-vibration system: continuously safe and pleasant working thanks to minimal vibrations and outstanding noise insulation.
- + StarlockPlus tool mounting: more work progress and greater precision thanks to 100 % power transmission without losses.
- + QuickIN: tool changes in less than 3 seconds thanks to the patented tool-free FEIN rapid clamping system.
- + With the StarlockPlus tool mounting, you can access around 100 FEIN accessories from the Starlock and StarlockPlus performance classes.
- + DC motor: effective and powerful motor technology offering virtually the same power as the mains-powered version.
- + Tacho generator: constant speeds even under load and infinitely variable electronic speed control.
- + Metal gearbox: ability to withstand high loading and outstanding service life because all the gearbox parts are made from metal.
- + Mechanical interface: for stationary operation in the table or drill jig holder or for securing the depth stop.
- + SafetyCell technology: perfect protection against overload, overheating and total discharge thanks to Li-ion batteries with individual cell monitoring.
- + The battery charge can be read off the battery.

MULTIMASTER MM 500 PLUS



SUPPLIED

1 Universal E-Cut saw blade (44 mm),
1 plastic carrying case

For accessories, see page 228

The powerful MultiTool for rapid work progress (in interior work and renovation) with a bimetal saw blade for wood, metal and plastics.

Input	W	350
Oscillations	rpm	10,000 - 19,500
Tool Holder		StarlockPlus
Tool change		QuickIN
Amplitude		2 x 1,7°
Cable with plug	m	5
Weight according to EPTA	kg	1,4

Part number	7 229 67 62 00 0
EAN	4014586893310

FEIN BENEFITS

- + Anti-vibration system: continuously safe and pleasant working thanks to minimal vibrations and outstanding noise insulation.
- + StarlockPlus tool mounting: more work progress and greater precision thanks to 100 % power transmission without losses.
- + QuickIN: tool changes in less than 3 seconds thanks to the patented tool-free FEIN rapid clamping system.
- + With the StarlockPlus tool mounting, you can access around 100 FEIN accessories from the Starlock and StarlockPlus performance classes.
- + 350 W FEIN motor. Powerful motor with a high copper content, which is suited to overload for a higher cutting speed and faster work progress.
- + Tacho generator: constant speeds even under load and infinitely variable electronic speed control.
- + Metal gearbox: ability to withstand high loading and outstanding service life because all the gearbox parts are made from metal.
- + Mechanical interface: for stationary operation in the table or drill jig holder or for securing the depth stop.
- + Industrial cable: large working radius thanks to finely stranded 5 metre rubber cable of industrial quality.

MULTIMASTER MM 500 PLUS TOP



SUPPLIED

1 E-Cut long-life saw blade (10 mm),
2 E-Cut long-life saw blades (35 mm),
2 E-Cut long-life saw blades (65 mm),
1 E-Cut carbide Pro saw blade (32 mm),
1 carbide saw blade (diameter 75 mm), 1 HM rasp (triangular),
1 Stopper knife, 1 Sanding plate with holes, with 5 sanding sheets, with holes for each of grit sizes 60, 80, 120, 180, 1 dust extraction device,
1 plastic carrying case

For accessories, see page 228

The powerful MultiTool for rapid work progress (in interior work and renovation) with more than 30 accessories for sawing in wood and metal, sanding, removing tiles and much more.

Input	W	350
Oscillations	rpm	10,000 - 19,500
Tool Holder		StarlockPlus
Tool change		QuickIN
Amplitude		2 x 1,7°
Cable with plug	m	5
Weight according to EPTA	kg	1,4

Part number	7 229 67 61 00 0
EAN	4014586893235

FEIN BENEFITS

- + Anti-vibration system: continuously safe and pleasant working thanks to minimal vibrations and outstanding noise insulation.
- + StarlockPlus tool mounting: more work progress and greater precision thanks to 100 % power transmission without losses.
- + QuickIN: tool changes in less than 3 seconds thanks to the patented tool-free FEIN rapid clamping system.
- + With the StarlockPlus tool mounting, you can access around 100 FEIN accessories from the Starlock and StarlockPlus performance classes.
- + 350 W FEIN motor. Powerful motor with a high copper content, which is suited to overload for a higher cutting speed and faster work progress.
- + Tacho generator: constant speeds even under load and infinitely variable electronic speed control.
- + Metal gearbox: ability to withstand high loading and outstanding service life because all the gearbox parts are made from metal.
- + Mechanical interface: for stationary operation in the table or drill jig holder or for securing the depth stop.
- + Industrial cable: large working radius thanks to finely stranded 5 metre rubber cable of industrial quality.

CORDLESS MULTIMASTER AMM 700 MAX SELECT



SUPPLIED

1 Universal E-Cut saw blade (44 mm),
1 plastic carrying case

For accessories, see page 228

Our best cordless MultiTool for the most rapid work progress in interior work and renovation in the variant without battery or charger – with a bimetal saw blade for wood, metal and plastics.

Battery voltage	V	18
Battery compatibility		Li-ion/ HighPower Li-ion
Battery interface		MultiVolt
Oscillations	rpm	10,000 - 19,500
Tool Holder		StarlockMax
Tool change		QuickIN
Amplitude		2 x 2,0°
Weight without storage battery	kg	1,1

Part number	7 129 34 62 00 0
EAN	4014586893174

FEIN BENEFITS

- + Anti-vibration system: continuously safe and pleasant working thanks to minimal vibrations and outstanding noise insulation.
- + StarlockMax tool mounting: more work progress and greater precision thanks to 100 % power transmission without losses.
- + QuickIN: tool changes in less than 3 seconds thanks to the patented tool-free FEIN rapid clamping system.
- + With the StarlockMax tool mounting, you can access around 180 FEIN accessories from the Starlock, Starlock Plus and StarlockMax performance classes.
- + 18 V FEIN PowerDrive motor: very powerful and virtually wear-free, brushless motor offering great efficiency, ability to handle extreme loads and a long service life.
- + Tacho generator: constant speeds even under load and infinitely variable electronic speed control.
- + Metal gearbox: ability to withstand high loading and outstanding service life because all the gearbox parts are made from metal.
- + Mechanical interface: for stationary operation in the table or drill jig holder or for securing the depth stop.
- + SafetyCell technology: perfect protection against overload, overheating and total discharge thanks to Li-ion batteries with individual cell monitoring.
- + Dust grille – protects tool from aggressive dusts.
- + The battery charge can be read off the battery.

CORDLESS MULTIMASTER AMM 700 MAX TOP



SUPPLIED

2 E-Cut standard saw blades curved (35 mm), 2 E-Cut standard saw blades curved (65 mm), 1 E-Cut precision saw blade (35 mm), 1 E-Cut precision saw blade (65 mm), 1 E-Cut long-life saw blade (10 mm), 2 E-Cut long-life saw blades (35 mm), 1 E-Cut long-life saw blade (32 mm), 1 E-Cut long-life saw blade (42 mm), 1 E-Cut carbide Pro saw blade (32 mm), 1 segmented saw blade (Ø 85 mm), 1 HSS segment saw blade, 1 HM rasp (triangular), 1 Stopper knife, 1 Cutter blade, mushroom shaped, 1 Multi-function knife, 1 Sanding plate with holes, Sanding sheets, perforated (10 each of grit 60, 80, 120, 180), 1 dust extraction device, 1 rapid charger ALG 80, 2 Li-ion battery packs (18 V / 3 Ah), 1 plastic carrying case

For accessories, see page 228

Our best MultiTool for the most rapid work progress in interior work and renovation with 60 accessories – from sawing in wood, metal and plastics, to cutting out tiles, cutting silicone joints and carpets, removing adhesive residues and tile adhesive.

Battery voltage	V	18
Battery capacity	Ah	3
Battery compatibility		Li-ion/ HighPower Li-ion
Battery interface		MultiVolt
Oscillations	rpm	10,000 - 19,500
Tool Holder		StarlockMax
Tool change		QuickIN
Amplitude		2 x 2,0°
Weight with battery	kg	1,6
Weight without storage battery	kg	1,1

Part number	7 129 34 61 00 0
EAN	4014586893112

FEIN BENEFITS

- + Anti-vibration system: continuously safe and pleasant working thanks to minimal vibrations and outstanding noise insulation.
- + StarlockMax tool mounting: more work progress and greater precision thanks to 100 % power transmission without losses.
- + QuickIN: tool changes in less than 3 seconds thanks to the patented tool-free FEIN rapid clamping system.
- + With the StarlockMax tool mounting, you can access around 180 FEIN accessories from the Starlock, Starlock Plus and StarlockMax performance classes.
- + 18 V FEIN PowerDrive motor: very powerful and virtually wear-free, brushless motor offering great efficiency, ability to handle extreme loads and a long service life.
- + Metal gearbox: ability to withstand high loading and outstanding service life because all the gearbox parts are made from metal.
- + Mechanical interface: for stationary operation in the table or drill jig holder or for securing the depth stop.
- + SafetyCell technology: perfect protection against overload, overheating and total discharge thanks to Li-ion batteries with individual cell monitoring.
- + The battery charge can be read off the battery.

MULTIMASTER MM 700 MAX



SUPPLIED

1 Universal E-Cut saw blade (44 mm),
1 plastic carrying case

For accessories, see page 228

Our best MultiTool for the most rapid work progress in interior work and renovation with a bimetal saw blade for wood, metal and plastics.

Input	W	450
Output	W	250
Oscillations	rpm	10,000 - 19,500
Tool Holder		StarlockMax
Tool change		QuickIN
Amplitude		2 x 2,0°
Cable with plug	m	5
Weight according to EPTA	kg	1,6

Part number	7 229 68 62 00 0
EAN	4014586893471

FEIN BENEFITS

- + Anti-vibration system: continuously safe and pleasant working thanks to minimal vibrations and outstanding noise insulation.
- + StarlockMax tool mounting: more work progress and greater precision thanks to 100 % power transmission without losses.
- + QuickIN: tool changes in less than 3 seconds thanks to the patented tool-free FEIN rapid clamping system.
- + With the StarlockMax tool mounting, you can access around 180 FEIN accessories from the Starlock, Starlock Plus and StarlockMax performance classes.
- + 450 W FEIN high-power motor: high-power motor with a high copper content, which is suited to continuous use and overload for maximum cutting speed and the most rapid work progress.
- + Tacho generator: constant speeds even under load and infinitely variable electronic speed control.
- + Metal gearbox: ability to withstand high loading and outstanding service life because all the gearbox parts are made from metal.
- + Mechanical interface: for stationary operation in the table or drill jig holder or for securing the depth stop.
- + Industrial cable: large working radius thanks to finely stranded 5 metre rubber cable of industrial quality.

MULTIMASTER MM 700 MAX TOP



SUPPLIED

2 E-Cut standard saw blades curved (35 mm), 2 E-Cut standard saw blades curved (65 mm), 1 E-Cut Precision BIM saw blade (35 mm), 1 E-Cut Precision BIM saw blade (35 mm), 1 E-Cut long-life saw blade (10 mm), 2 E-Cut long-life saw blades (35 mm), 1 E-Cut long-life saw blade (32 mm), 1 E-Cut long-life saw blade (42 mm), 1 E-Cut carbide Pro saw blade (32 mm), 1 segmented saw blade (Ø 85 mm), 1 carbide saw blade (diameter 75 mm), 1 HM rasp (triangular), 1 Stopper knife, 1 Cutter blade, mushroom shaped, 1 Multi-function knife, 1 Sanding plate with holes, Sanding sheets, perforated (10 each of grit 60, 80, 120, 180), 1 dust extraction device, 1 plastic carrying case

For accessories, see page 228

Our best MultiTool for the most rapid work progress in interior work and renovation with 60 accessories – from sawing in wood, metal and plastics, to cutting out tiles, cutting silicone joints and carpets, removing adhesive residues and tile adhesive.

Input	W	450
Output	W	250
Oscillations	rpm	10,000 - 19,500
Tool Holder		StarlockMax
Tool change		QuickIN
Amplitude		2 x 2,0°
Cable with plug	m	5
Weight according to EPTA	kg	1,6

Part number	7 229 68 61 00 0
EAN	4014586893396

FEIN BENEFITS

- + Anti-vibration system: continuously safe and pleasant working thanks to minimal vibrations and outstanding noise insulation.
- + StarlockMax tool mounting: more work progress and greater precision thanks to 100 % power transmission without losses.
- + QuickIN: tool changes in less than 3 seconds thanks to the patented tool-free FEIN rapid clamping system.
- + With the StarlockMax tool mounting, you can access around 180 FEIN accessories from the Starlock, Starlock Plus and StarlockMax performance classes.
- + 450 W FEIN high-power motor: high-power motor with a high copper content, which is suited to continuous use and overload for maximum cutting speed and the most rapid work progress.
- + Tacho generator: constant speeds even under load and infinitely variable electronic speed control.
- + Metal gearbox: ability to withstand high loading and outstanding service life because all the gearbox parts are made from metal.
- + Mechanical interface: for stationary operation in the table or drill jig holder or for securing the depth stop.
- + Industrial cable: large working radius thanks to finely stranded 5 metre rubber cable of industrial quality.

For more than 50 years, the range of FEIN accessories for our MultiTools has grown to meet your changing requirements.



FEIN BENEFITS

- + More than 180 different accessories for thousands of professional and special applications.
- + Made in Germany: All FEIN saw blades are produced in Germany.
- + 14 accessory kits – perfectly put together for varied applications.
- + Outstanding cost-effectiveness thanks to fast work progress and a long service life.
- + Made by FEIN: Each accessory is developed, manufactured and checked by FEIN.

Select the Starlock accessories to suit your tool:

Here you can see at a glance which tool holder you have on your power tool, which accessories fit it, and whether you need an adapter for them.



		STARLOCK	STARLOCK PLUS	STARLOCK MAX	12-sided
FEIN MULTIMASTER & MultiTalent	STARLOCK MAX e.g. MULTIMASTER (A)MM 700	✓	✓	✓	✗
	STARLOCK PLUS e.g. MULTIMASTER (A)MM 300 and (A)MM 500 FMM 350 QSL & FMT 250 QSL	✓	✓	✗	✗
	EIGHT STAR TOOL HOLDER 2007 – 2015 e.g. FMM 250 FMM 250 QuickIN	✓	✓	✗	✗
	ROUND HOLDER 10MM 1986 – 2006 e.g. ASTxe 636-2 MSx636 MSxe 636-1	✓**	✓**	✗	✗
FEIN SuperCut	STARLOCK MAX e.g. FSC 500 QSL AFSC 18 QSL	✓	✓	✓	✗
	HEXAGON SOCKET WITH QUICKIN 2010 TO 2016 e.g. FSC 2.0 Q FSC 1.6 Q AFSC 1.7 Q AFSC 18 3 52 22 952 05 0*				✓
	HEXAGON SOCKET 2004 TO 2009 e.g. FSC 2.0 FSC 1.6 3 52 22 952 04 0*				✓
Others	Bosch, Festool, Würth	✓	✓***	✓***	
	Other manufacturers e.g. AEG Rigid Skil Makita Einhell and many others.	✓	✗	✗	

Always fits

* Adapter is essential.
 ** Functionality improved with upgrade kit: not essential.
 *** Depends on power tool.

SAWING



SAW BLADE

For all soft materials. Segmented, ideal for working in corners and on edges without overcutting.

Ø mm	Mount	Part number
85	SL	6 35 02 113 21 0



HSS SAW BLADE

Solid HSS saw blade with metal teeth for sheet metal up to approx. 1 mm. Also for plastics, fibreglass-reinforced plastic, wood, putty and copper/copper alloys. Outstanding cutting speed. Clean, thin cutting line. Circular shape delivers good cost-effectiveness.

Ø mm	Mount	No. in pack pcs	Part number
85	SL	1	6 35 02 097 21 0
85	SL	2	6 35 02 097 22 0
85	SL	5	6 35 02 097 23 0



Segmented, ideal for working in corners and on edges without overcutting.

Ø mm	Mount	No. in pack pcs	Part number
85	SL	1	6 35 02 106 21 0
85	SL	2	6 35 02 106 22 0
85	SL	5	6 35 02 106 23 0



HSS SAW BLADE

Bimetal for long tool life. Metal teeth for sheet metal up to approx. 1 mm. Also for plastics, fibreglass-reinforced plastic, wood, putty and copper/copper alloys. Work flush with the surface. Circular shape delivers good cost-effectiveness.

Ø mm	Mount	No. in pack pcs	Part number
85	SL	1	6 35 02 174 21 0
85	SL	5	6 35 02 174 23 0



Circular shape and extra large diameter deliver optimum cost-effectiveness.

Ø mm	Mount	No. in pack pcs	Part number
100	SLP	1	6 35 02 175 21 0
100	SLP	5	6 35 02 175 23 0



Segmented, ideal for working in corners and on edges without overcutting.

Ø mm	Mount	No. in pack pcs	Part number
100	SL	1	6 35 02 196 21 0
100	SL	5	6 35 02 196 23 0



HSS SAW BLADE

Bimetal for long tool life. Set wood teeth. Outstanding tool life, high cutting quality and speed. As "mini circular saw", ideal for long, straight cuts and for making cut-outs in laid parquet, laminate and wall panelling.

Ø mm	Mount	No. in pack pcs	Part number
100	SLP	1	6 35 02 176 21 0



HSS SAW BLADE SET

Bimetal for long tool life. Set wood teeth. Outstanding tool life, high cutting quality and speed. As "mini circular saw", ideal for long, straight cuts and for making cut-outs in laid parquet, laminate and wall panelling. The depth stop can also be used with many other FEIN accessories. For accurate working at depth. StarlockPlus fitting, suitable for all popular multi-function tools with StarlockPlus and StarlockMax fitting and for all FEIN MultiTalent and MULTIMASTER tools up until 04/16. Scope of supply: 1 HSS saw blade, 1 depth stop (suitable for (A)MM 500 / 700)

Ø mm	Mount	Part number
100	SLP	3 52 22 952 01 0



CONTACT GUARD

Spare contact guard for HSS saw blade 6 35 02 176 21 0.

Part number
3 43 00 000 00 1



DEPTH STOP

Depth stop for all saw blades. For accurate working at depth. Effective protection for blade and workpiece. Contents: 1 adapter for attachment to the machine. 1 depth stop, 1 depth-adjustable guide block. Can only be used with (A)MM 500 / 700.

Part number
3 21 27 069 01 0



BEST OF E-CUT STARLOCK WOOD & METAL

6 E-Cut plunge-cut saw blades for sawing in wood and metal. Suitable for all FEIN MultiTools and all other common Multi-Tools on the market. Available as a set, offering significant savings over purchasing the items individually. Content: E-Cut long-life saw blades (2 each of 50 x 35 mm, 50 x 65 mm), E-Cut universal saw blade (1 each of 55 x 28 mm, 55 x 44 mm).

Mount	Part number
SL	3 52 22 967 01 0



BEST OF E-CUT STARLOCKPLUS WOOD & METAL

6 E-Cut plunge-cut saw blades for sawing in wood and metal. Suitable for all FEIN MultiTools and all other common Multi-Tools with Starlock-Plus and StarlockMax mounting. Available as a set, offering significant savings over purchasing the items individually. Content: E-Cut long-life saw blades (2 each of 50 x 35 mm, 50 x 65 mm), E-Cut universal saw blade (1 each of 60 x 28 mm, 60 x 44 mm).

Mount	Part number
SLP	3 52 22 967 03 0



BEST OF E-CUT STARLOCKMAX WOOD & METAL

6 extra long E-Cut plunge-cut saw blades for large plunge depths and effective working in wood and metal. Suitable for FEIN MultiTools with StarlockMax mounting and all other common MultiTools with StarlockMax mounting. Available as a set, offering significant savings over purchasing the items individually. Content: E-Cut long-life saw blades (2 each of 78 x 32 mm, 78 x 42 mm), 2 E-Cut long-life saw blades (90 x 32 mm).

Mount	Part number
SLM	3 52 22 967 05 0



STARLOCK WOOD & METAL E-CUT COMBO

3 E-Cut plunge-cut saw blades for sawing in wood and metal. Suitable for all FEIN MultiTools and all other common MultiTools with Starlock mounting. Available as a set, offering significant savings over purchasing the items individually. Content: 2 E-Cut long-life saw blades (50 x 35 mm, 50 x 65 mm), 1 E-Cut universal saw blade (55 x 44 mm).

Mount	Part number
SL	3 52 22 967 10 0



STARLOCK WOOD E-CUT COMBO

3 E-Cut plunge-cut saw blades for precise sawing in wooden materials. Suitable for all FEIN MultiTools and all other common MultiTools with Starlock mounting. Available as a set, offering significant savings over purchasing the items individually. Content: 1 E-Cut standard saw blade, curved (50 x 50 mm), E-Cut precision BIM saw blade (1 each of 50 x 35 mm, 50 x 65 mm).

Mount	Part number
SL	3 52 22 967 08 0



STARLOCK MINI CUT COMBO

3 accessories, ideal for cutting smaller recesses and working in tight spots, e.g. for numerous installation jobs, switch installation, model-building and more. Suitable for all FEIN MultiTools and all other common MultiTools with Starlock mounting. Available as a set, offering significant savings over purchasing the items individually. Content: E-Cut long-life saw blades (2 of 30 x 10 mm, 35 x 20 mm), 1 carbide file (30 x 10 mm).

Mount	Part number
SL	3 52 22 967 09 0



E-CUT LONG-LIFE SAW BLADE

Bimetal with set wood teeth for all wood, plasterboard and plastic materials. Outstanding tool life, high cutting quality and speed. Extremely robust, not affected by nails (up to diameter of approx. 4 mm) in wood, masonry etc. Short, very narrow shape for the smallest of recesses.

Width mm	Length mm	Mount	No. in pack pcs	Part number
10	30	SL	1	6 35 02 184 21 0
10	30	SL	3	6 35 02 184 22 0
10	30	SL	5	6 35 02 184 23 0
10	30	SL	10	6 35 02 184 24 0
10	30	SL	50	6 35 02 184 25 0



Short, very narrow shape for the smallest of recesses.

Width mm	Length mm	Mount	No. in pack pcs	Part number
20	34	SL	1	6 35 02 183 21 0
20	34	SL	3	6 35 02 183 22 0
20	34	SL	5	6 35 02 183 23 0
20	34	SL	10	6 35 02 183 24 0
20	34	SL	50	6 35 02 183 25 0



Medium width, with waist for optimum cutting speed and good swarf removal.

Width mm	Length mm	Mount	No. in pack pcs	Part number
35	50	SL	1	6 35 02 160 21 0
35	50	SL	3	6 35 02 160 22 0
35	50	SL	5	6 35 02 160 23 0
35	50	SL	10	6 35 02 160 24 0
35	50	SL	50	6 35 02 160 25 0



Wide shape for maximum cutting performance and long, straight cuts.

Width mm	Length mm	Mount	No. in pack pcs	Part number
50	50	SL	1	6 35 02 221 21 0
50	50	SL	3	6 35 02 221 22 0
50	50	SL	5	6 35 02 221 23 0
50	50	SL	10	6 35 02 221 24 0
50	50	SL	50	6 35 02 221 25 0



Wide shape for maximum cutting performance and long, straight cuts.

Width mm	Length mm	Mount	No. in pack pcs	Part number
65	50	SL	1	6 35 02 228 21 0
65	50	SL	3	6 35 02 228 22 0
65	50	SL	5	6 35 02 228 23 0
65	50	SL	10	6 35 02 228 24 0
65	50	SL	50	6 35 02 228 25 0



Extra wide shape for maximum cutting performance and long, straight cuts.

Width mm	Length mm	Mount	No. in pack pcs	Part number
65	50	SLP	1	6 35 02 161 21 0
65	50	SLP	3	6 35 02 161 22 0
65	50	SLP	5	6 35 02 161 23 0
65	50	SLP	10	6 35 02 161 24 0
65	50	SLP	50	6 35 02 161 25 0



Long, narrow shape for large plunge depths. With waist for optimum cutting speed and good swarf removal.

Width mm	Length mm	Mount	No. in pack pcs	Part number
32	78	SLM	1	6 35 02 201 21 0
32	78	SLM	3	6 35 02 201 22 0
32	78	SLM	5	6 35 02 201 23 0
32	78	SLM	10	6 35 02 201 24 0
32	78	SLM	50	6 35 02 201 25 0



Long, wide shape for large plunge depths and effective working. With waist for optimum cutting speed and good swarf removal.

Width mm	Length mm	Mount	No. in pack pcs	Part number
42	78	SLM	1	6 35 02 203 21 0
42	78	SLM	3	6 35 02 203 22 0
42	78	SLM	5	6 35 02 203 23 0
42	78	SLM	10	6 35 02 203 24 0
42	78	SLM	50	6 35 02 203 25 0



XXL length for very large plunge depths and special application solutions, such as replacing windows. With waist for optimum cutting speed and good swarf removal.

Width mm	Length mm	Mount	No. in pack pcs	Part number
32	90	SLM	1	6 35 02 224 21 0
32	90	SLM	3	6 35 02 224 22 0
32	90	SLM	5	6 35 02 224 23 0
32	90	SLM	10	6 35 02 224 24 0
32	90	SLM	50	6 35 02 224 25 0



E-CUT STANDARD SAW BLADE

Set teeth for all wood, plasterboard and plastic materials, high cutting quality and speed. Medium width, with waist for optimum cutting speed and good swarf removal.

Width mm	Length mm	Mount	No. in pack pcs	Part number
35	50	SL	1	6 35 02 133 21 0
35	50	SL	3	6 35 02 133 22 0
35	50	SL	5	6 35 02 133 23 0
35	50	SL	10	6 35 02 133 24 0
35	50	SL	50	6 35 02 133 25 0



E-CUT STANDARD SAW BLADE

Set teeth for all wood, plasterboard and plastic materials, high cutting quality and speed. Wide shape for maximum cutting performance and long, straight cuts.

Width mm	Length mm	Mount	No. in pack pcs	Part number
65	50	SLP	1	6 35 02 134 21 0
65	50	SLP	3	6 35 02 134 22 0
65	50	SLP	5	6 35 02 134 23 0
65	50	SLP	10	6 35 02 134 24 0
65	50	SLP	50	6 35 02 134 25 0



Long, narrow shape for large plunge depths. With waist for optimum cutting speed and good swarf removal.

Width mm	Length mm	Mount	No. in pack pcs	Part number
32	78	SLM	1	6 35 02 200 21 0
32	78	SLM	3	6 35 02 200 22 0
32	78	SLM	5	6 35 02 200 23 0
32	78	SLM	10	6 35 02 200 24 0
32	78	SLM	50	6 35 02 200 25 0



Long, wide shape for large plunge depths and effective working. With waist for optimum cutting speed and good swarf removal.

Width mm	Length mm	Mount	No. in pack pcs	Part number
42	78	SLM	1	6 35 02 202 21 0
42	78	SLM	3	6 35 02 202 22 0
42	78	SLM	5	6 35 02 202 23 0
42	78	SLM	10	6 35 02 202 24 0
42	78	SLM	50	6 35 02 202 25 0



E-CUT STANDARD SAW BLADE CURVED

Set teeth for all wood, plasterboard and plastic materials, high cutting quality and speed. Curved cutting geometry for optimum plunging and clean precise cut edges, especially on smooth surfaces. Narrow, with waist for optimum cutting speed and good swarf removal.

Width mm	Length mm	Mount	No. in pack pcs	Part number
35	55	SL	1	6 35 02 227 21 0
35	55	SL	3	6 35 02 227 22 0
35	55	SL	5	6 35 02 227 23 0
35	55	SL	10	6 35 02 227 24 0
35	55	SL	50	6 35 02 227 25 0



Medium width for various uses.

Width mm	Length mm	Mount	No. in pack pcs	Part number
50	50	SL	1	6 35 02 226 21 0
50	50	SL	3	6 35 02 226 22 0
50	50	SL	5	6 35 02 226 23 0
50	50	SL	10	6 35 02 226 24 0
50	50	SL	50	6 35 02 226 25 0



Wide shape for maximum cutting performance and long, straight cuts.

Width mm	Length mm	Mount	No. in pack pcs	Part number
65	50	SL	1	6 35 02 225 21 0
65	50	SL	3	6 35 02 225 22 0
65	50	SL	5	6 35 02 225 23 0
65	50	SL	10	6 35 02 225 24 0
65	50	SL	50	6 35 02 225 25 0



E-CUT PRECISION BIM SAW BLADE

Bimetal with double-row Japan teeth for all wooden materials, plasterboard and soft plastics. Improved tool life and robustness. The fastest cutting speed and maximum precision. Narrow, with waist for optimum cutting speed and good swarf removal.

Width mm	Length mm	Mount	No. in pack pcs	Part number
35	50	SL	1	6 35 02 205 21 0
35	50	SL	3	6 35 02 205 22 0
35	50	SL	5	6 35 02 205 23 0
35	50	SL	10	6 35 02 205 24 0
35	50	SL	50	6 35 02 205 25 0



Medium width for various uses.

Width mm	Length mm	Mount	No. in pack pcs	Part number
50	50	SL	1	6 35 02 232 21 0
50	50	SL	3	6 35 02 232 22 0
50	50	SL	5	6 35 02 232 23 0
50	50	SL	10	6 35 02 232 24 0
50	50	SL	50	6 35 02 232 25 0



Extra wide shape for maximum cutting performance and long, straight cuts.

Width mm	Length mm	Mount	No. in pack pcs	Part number
65	50	SL	1	6 35 02 229 21 0
65	50	SL	3	6 35 02 229 22 0
65	50	SL	5	6 35 02 229 23 0
65	50	SL	10	6 35 02 229 24 0
65	50	SL	50	6 35 02 229 25 0



Extra wide shape for maximum cutting performance and long, straight cuts.

Width mm	Length mm	Mount	No. in pack pcs	Part number
65	50	SLP	1	6 35 02 208 21 0
65	50	SLP	3	6 35 02 208 22 0
65	50	SLP	5	6 35 02 208 23 0
65	50	SLP	10	6 35 02 208 24 0
65	50	SLP	50	6 35 02 208 25 0



E-CUT PRECISION SAW BLADE

Double-row Japan teeth for all wooden materials, plasterboard and soft plastics. The fastest cutting speed and maximum precision. Narrow, with waist for optimum cutting speed and good swarf removal.

Width mm	Length mm	Mount	No. in pack pcs	Part number
35	50	SL	1	6 35 02 126 21 0
35	50	SL	3	6 35 02 126 22 0
35	50	SL	5	6 35 02 126 23 0
35	50	SL	10	6 35 02 126 24 0
35	50	SL	50	6 35 02 126 25 0



Medium width for various uses.

Width mm	Length mm	Mount	No. in pack pcs	Part number
50	50	SL	1	6 35 02 233 21 0
50	50	SL	3	6 35 02 233 22 0
50	50	SL	5	6 35 02 233 23 0
50	50	SL	10	6 35 02 233 24 0
50	50	SL	50	6 35 02 233 25 0



Extra wide shape for maximum cutting performance and long, straight cuts.

Width mm	Length mm	Mount	No. in pack pcs	Part number
65	50	SL	1	6 35 02 230 21 0
65	50	SL	3	6 35 02 230 22 0
65	50	SL	5	6 35 02 230 23 0
65	50	SL	10	6 35 02 230 24 0
65	50	SL	50	6 35 02 230 25 0



Extra wide shape for maximum cutting performance and long, straight cuts.

Width mm	Length mm	Mount	No. in pack pcs	Part number
65	50	SLP	1	6 35 02 127 21 0
65	50	SLP	3	6 35 02 127 22 0
65	50	SLP	5	6 35 02 127 23 0
65	50	SLP	10	6 35 02 127 24 0
65	50	SLP	50	6 35 02 127 25 0



E-CUT UNIVERSAL SAW BLADE

Bimetal with corrugated universal teeth. Wide range of applications for sheet metal up to 2 mm, aluminium profiles, copper pipes, wood, plasterboard and plastics. Narrow, with waist for optimum cutting speed and good swarf removal.

Width mm	Length mm	Mount	No. in pack pcs	Part number
28	55	SL	1	6 35 02 222 21 0
28	55	SL	3	6 35 02 222 22 0
28	55	SL	5	6 35 02 222 23 0
28	55	SL	10	6 35 02 222 24 0
28	55	SL	50	6 35 02 222 25 0



Narrow, with waist for optimum cutting speed and good swarf removal.

Width mm	Length mm	Mount	No. in pack pcs	Part number
28	60	SLP	1	6 35 02 151 21 0
28	60	SLP	3	6 35 02 151 22 0
28	60	SLP	5	6 35 02 151 23 0
28	60	SLP	10	6 35 02 151 24 0
28	60	SLP	50	6 35 02 151 25 0



Medium width, with waist for optimum cutting speed and good swarf removal.

Width mm	Length mm	Mount	No. in pack pcs	Part number
44	55	SL	1	6 35 02 223 21 0
44	55	SL	3	6 35 02 223 22 0
44	55	SL	5	6 35 02 223 23 0
44	55	SL	10	6 35 02 223 24 0
44	55	SL	50	6 35 02 223 25 0



Medium width, with waist for optimum cutting speed and good swarf removal.

Width mm	Length mm	Mount	No. in pack pcs	Part number
44	60	SLP	1	6 35 02 152 21 0
44	60	SLP	3	6 35 02 152 22 0
44	60	SLP	5	6 35 02 152 23 0
44	60	SLP	10	6 35 02 152 24 0
44	60	SLP	50	6 35 02 152 25 0



E-CUT FINE SAW BLADE

Bimetal with fine teeth for sheet metal up to 2 mm, aluminium profiles, copper pipes. Also for fibreglass-reinforced plastic and other hard plastics. Extremely precise cuts which are very easy to control with particularly thin cutting line. Narrow, with waist for optimum cutting speed and good swarf removal.

Width mm	Length mm	Mount	No. in pack pcs	Part number
30	50	SL	1	6 35 02 157 21 0
30	50	SL	3	6 35 02 157 22 0
30	50	SL	5	6 35 02 157 23 0
30	50	SL	10	6 35 02 157 24 0
30	50	SL	50	6 35 02 157 25 0



E-CUT CARBIDE PRO

TiN-coated carbide plunge-cut saw blade with extremely good resistance to wear. Lasts 100 % longer than uncoated carbide saw blades. Lasts 30 times longer than HSS saw blades. The right choice for tough materials, such as ferrous metals, stainless steel or copper pipes. Can even be used for hardened screws (Spax) and high-strength machine screws. But also ideally suited to abrasive materials, such as bricks, masonry or fibre cement boards as well as laminate, carbon fibre-reinforced plastic and fibreglass-reinforced plastic. Good cutting results and cutting quality in all timber materials, such as hardwood or chipboard. Narrow, with waist for optimum cutting speed and good swarf removal.

Width mm	Length mm	Mount	No. in pack pcs	Part number
32	40	SL	1	6 35 02 236 21 0
32	40	SL	3	6 35 02 236 22 0
32	40	SL	5	6 35 02 236 23 0
32	40	SL	10	6 35 02 236 24 0
32	40	SL	50	6 35 02 236 25 0



Narrow, with waist for optimum cutting speed and good swarf removal.

Width mm	Length mm	Mount	No. in pack pcs	Part number
32	60	SLP	1	6 35 02 237 21 0
32	60	SLP	3	6 35 02 237 22 0
32	60	SLP	5	6 35 02 237 23 0
32	60	SLP	10	6 35 02 237 24 0
32	60	SLP	50	6 35 02 237 25 0



Narrow, with waist for optimum cutting speed and good swarf removal.

Width mm	Length mm	Mount	No. in pack pcs	Part number
32	75	SLM	1	6 35 02 238 21 0
32	75	SLM	3	6 35 02 238 22 0
32	75	SLM	5	6 35 02 238 23 0
32	75	SLM	10	6 35 02 238 24 0



CARBIDE SAW BLADE

Open teeth for perfect, clean cut edges in carbon fibre-reinforced plastic/fibreglass-reinforced plastic materials without delamination. Distortion-free, long, straight cuts at high cutting speed and with precision. Extra thin version. Cutting width approx. 1.2 mm. Segmented, ideal for working in corners and on edges without overcutting.

Ø mm	Mount	Part number
90	SLP	6 35 02 187 21 0



DIAMOND-COATED SAW BLADE

Open teeth for perfect, clean cut edges in carbon fibre-reinforced plastic/fibreglass-reinforced plastic materials without delamination. Distortion-free, long, straight cuts at high cutting speed and with precision. Diamond coating for outstanding service life. Extra thin version. Cutting width approx. 1.2 mm. Segmented, ideal for working in corners and on edges without overcutting.

Ø mm	Mount	Part number
90	SLP	6 35 02 188 21 0



Diamond coating for outstanding service life. Extra thin version. Cutting width approx. 1.2 mm.

Ø mm	Mount	Part number
105	SLM	6 35 02 220 21 0



E-CUT CARBIDE SAW BLADE

Gentle sawing with perfect, clean cut edges in carbon fibre-reinforced plastic/fibreglass-reinforced plastic materials without delamination. Particularly well suited to precise cut-outs and short cuts. Precise working into the corners and on edges.

Width mm	Length mm	Mount	Part number
35	50	SLP	6 35 02 191 21 0



E-CUT DIAMOND SAW BLADE

Diamond coating for outstanding service life. Gentle sawing with perfect, clean cut edges in carbon fibre-reinforced plastic/fibreglass-reinforced plastic materials without delamination. Particularly well suited to precise cut-outs and short cuts. Precise working into the corners and on edges.

Width mm	Length mm	Mount	Part number
44	60	SLM	6 35 02 204 21 0
35	50	SLP	6 35 02 193 21 0



SEGMENT SAW BLADE

For cutting out putty-mounted isolation glass.

Mount	No. in pack pcs	Part number
SLM	2	6 39 03 244 22 0



BEST OF STARLOCK RENOVATION

Accessory kit containing 26 parts for upcoming renovation work. Suitable for all FEIN MultiTools and all other common MultiTools with Starlock mounting. Available as a set, offering significant savings over purchasing the items individually. Content: 6 E-Cut long-life saw blades (2 each of 50 x 35 mm, 50 x 50 mm, 50 x 65 mm), 1 carbide rasp (80 mm), 1 carbide segment saw blade (diameter 75 mm, 2.2 mm), 1 rigid stopper knife, 1 cutter blade, (mushroom-shaped), 1 sanding pad, unperforated (80 mm), sanding sheets (5 each of grit 60, 80, 120).

Mount	Part number
SL	3 52 22 967 06 0



BEST OF STARLOCK METAL

6 saw blades, especially for machining hardened and non-hardened metals. Suitable for all FEIN MultiTools and all other common MultiTools with Starlock mounting. Available as a set, offering significant savings over purchasing the items individually. Content: 1 E-Cut CarbidePRO saw blade (40 x 32 mm), E-Cut long-life saw blades (1 each of 50 x 35 mm and 50 x 50 mm), 1 E-Cut universal saw blade (55 x 44 mm), 1 E-Cut fine saw blade (50 x 30 mm), 1 complete HSS segment saw blade (diameter 85 mm).

Mount	Part number
SL	3 52 22 967 02 0



STARLOCKMAX INTERIOR WORK PROFESSIONAL SET

Accessory kit containing 45 parts with extensive range of saw blades for fast, precise sawing in all kinds of installation work. Suitable for FEIN MultiTools with StarlockMax mounting and all other common MultiTools with StarlockMax mounting. Available as a set, offering significant savings over purchasing the items individually. Content: 8 E-Cut long-life saw blades (1 set of 34 x 20 mm, 2 each of 50 x 35 mm and 50 x 65 mm, 1 each of 78 x 32 mm, 78 x 42 mm and 90 x 32 mm), E-Cut precision BIM saw blade (1 each of 50 x 35 mm, 50 x 65 mm), 1 HSS circular saw blade (diameter 100 mm), 1 depth stop, 1 rigid stopper knife, long, 1 extraction device, anti-static, 1 sanding pad, perforated (80 mm), sanding sheets, perforated (10 each of grit 60, 80, 120).

Mount	Part number
SLM	3 52 22 967 12 0



STARLOCK RENOVATION COMBO

3 accessories, especially for renovation work on flooring. Suitable for all FEIN MultiTools and all other common MultiTools with Starlock mounting. Available as a set, offering significant savings over purchasing the items individually. Content: 1 carbide segment saw blade (diameter 85 mm), 1 E-Cut long-life saw blade (50 x 35 mm), 1 rigid stopper knife.

Mount	Part number
SL	3 52 22 967 11 0

GRINDING



BEST OF STARLOCK SANDING

Accessory kit containing 63 parts for sanding in corners and on edges. Suitable for all FEIN MultiTools and all other common MultiTools with Starlock mounting. Available as a set, offering significant savings over purchasing the items individually. Content: 2 sanding pads, unperforated (80 mm), 1 sanding finger, sanding sheets (10 each of grit 60, 80, 120) for sanding pad and sanding finger.

Mount	Part number
SL	3 52 22 967 04 0



SANDING PAD SET, UNPERFORATED

Standard version. Plastic carrier plate for preventing damage and marks on the workpiece. Triangular shape, hook and loop fastening.

Edge length mm	Mount	No. in pack pcs	Part number
80	SL	2	6 38 06 129 22 0



SANDING PAD SET, FLAT

For very narrow, flat openings (e.g. slats on cupboards, window shutters). Plastic carrier plate for preventing damage and marks on the workpiece. Triangular shape, flat version, hook and loop fastening.

Edge length mm	Mount	No. in pack pcs	Part number
80	SL	2	6 38 06 142 22 0



SUPERSOFT SANDING PAD

For special areas of application such as touching up aluminium rims and paint repairs. Plastic carrier plate for preventing damage and marks on the workpiece. Only use with "Sanding sheets, super-soft".
Triangular shape, super-soft version, hook and loop fastening.

Edge length mm	Mount	No. in pack pcs	Part number
80	SL	2	6 38 06 141 22 0



SET OF SANDING SHEETS

50 sanding sheets of various grits for the universal use of coarse to fine sanding on virtually all materials. High sanding capacity, little clogging and long service life guaranteed thanks to corundum abrasive grit and full bonding with artificial resins. Content: sanding sheets, 10 each of grit 60, 80, 120, 180 and 240, non-perforated, with hook and loop fastening. Better value than buying items separately.

Edge length mm	Part number
80	6 37 17 082 03 3



SANDING SHEETS

High sanding capacity, little clogging and long service life guaranteed thanks to corundum abrasive grit and full bonding with artificial resins. For universal use on virtually all materials. Non-perforated, hook and loop fastening.

Grain	Edge length mm	No. in pack pcs	Part number
36	80	5	6 37 17 086 04 8
40	80	5	6 37 17 081 04 6
60	80	5	6 37 17 082 04 9
80	80	5	6 37 17 083 04 3
100	80	5	6 37 17 084 04 1
120	80	5	6 37 17 085 04 5
150	80	5	6 37 17 087 04 2
180	80	5	6 37 17 088 04 0
220	80	5	6 37 17 089 04 4
240	80	5	6 37 17 090 04 6
36	80	50	6 37 17 086 01 0
40	80	50	6 37 17 081 01 8
60	80	50	6 37 17 082 01 1
80	80	50	6 37 17 083 01 5
100	80	50	6 37 17 084 01 3
120	80	50	6 37 17 085 01 7
150	80	50	6 37 17 087 01 4
180	80	50	6 37 17 088 01 2
220	80	50	6 37 17 089 01 6
240	80	50	6 37 17 090 01 8



SANDING SHEETS, ZIRCONIUM

Excellent sanding capacity on extremely hard surfaces such as varnish (e.g. parquet paint) or metal. The sanding sheet for all floor covering work. Extremely sturdy paper quality thanks to extremely tough full bonding with artificial resins and high-quality zirconium corundum coating. Non-perforated, hook and loop fastening.

Grain	Edge length mm	No. in pack pcs	Part number
40	80	35	6 37 17 243 01 0
60	80	35	6 37 17 244 01 0
80	80	35	6 37 17 245 01 0



SUPERSOFT SANDING SHEETS

Special sanding sheets for machining aluminium rims, performing touch-up work on dust inclusions, dealing with paint runs, overspray on wood, plastic, metal, etc. Only to be used in conjunction with the sanding pad 6 38 06 141 02 6. Non-perforated, hook and loop fastening.

Grain	Edge length mm	No. in pack pcs	Part number
240	80	50	6 37 17 126 01 5
320	80	50	6 37 17 127 01 9
400	80	50	6 37 17 128 01 7
500	80	50	6 37 17 179 01 6



STONE SANDING SHEETS

Specially for working with natural and artificial stone. Available up to grit 800 for a perfect surface finish in fine sanding. Non-perforated, hook and loop fastening.

Grain	Edge length mm	No. in pack pcs	Part number
40	80	50	6 37 17 120 01 4
80	80	50	6 37 17 121 01 3
120	80	50	6 37 17 122 01 6
220	80	50	6 37 17 123 01 0
320	80	50	6 37 17 124 01 8
400	80	50	6 37 17 125 01 2
600	80	50	6 37 17 175 01 7



SANDING FINGER

For use in very narrow and deep places, in channels, grooves, openings and folds. Also in mould-making, on concave forms and in convex forms. Plastic carrier plate for preventing damage and marks on the workpiece. Finger shape, hook and loop fastening.

Mount	No. in pack pcs	Part number
SL	2	6 38 06 159 22 0



SANDING SHEETS FOR SANDING FINGERS

With Velcro rapid attachment, fully bonded with artificial resin, high sanding capacity, corundum. For use on: wood, metal, soldered joints, fibreglass, plastic, paint, filler, leather. Pack of 20

Grain	No. in pack pcs	Part number
40	20	6 37 17 184 01 2
60	20	6 37 17 185 01 6
80	20	6 37 17 186 01 9
100	20	6 37 17 187 01 3
120	20	6 37 17 188 01 1
150	20	6 37 17 189 01 5
180	20	6 37 17 190 01 7
220	20	6 37 17 191 01 6
240	20	6 37 17 192 01 9



PROFILE GRINDING SET

22-part set for sanding in grooves and on outside radii. Contents: 1 holder with 6 different profile inserts. 1 x V-form for 90° angle, 1 x trapezium form for tongue-and-groove connections, 1 x straight form for profiles, 1 x convex form (large), 1 x concave and 1 x convex form (small) and sanding sheets, 5 each of 80, 120 and 180 grit.

Mount	Part number
SLP	6 38 10 031 01 0



SANDPAPER FOR PROFILE SANDING SET

High sanding capacity, little clogging and long service life guaranteed thanks to corundum abrasive grit and full bonding with artificial resins. For universal use on virtually all materials, non-perforated.

Grain	No. in pack pcs	Part number
80	25	6 37 17 217 01 6
120	25	6 37 17 218 01 4
180	25	6 37 17 219 01 8



SANDING PAD SET, PERFORATED

Standard version for sanding with dust extraction. Plastic carrier plate for preventing damage and marks on the workpiece. Triangular shape, perforated version, hook and loop fastening.

Edge length mm	Mount	No. in pack pcs	Part number
80	SL	2	6 38 06 136 22 0



SET OF SANDING SHEETS

50 sanding sheets of various grits for the universal use of coarse to fine sanding on virtually all materials. High sanding capacity, little clogging and long service life guaranteed thanks to corundum abrasive grit and full bonding with artificial resins. Content: sanding sheets, 10 each of grit 60, 80, 120, 180, 240, perforated, for use with perforated sanding pad and dust extraction, hook and loop fastening. Better value than buying items separately.

Edge length mm	Part number
80	6 37 17 109 03 5



SANDING SHEETS, PERFORATED

High sanding capacity, little clogging and long service life guaranteed thanks to corundum abrasive grit and full bonding with artificial resins. For universal use on virtually all materials. Perforated, for use with perforated sanding pad and dust extraction, hook and loop fastening.

Grain	Edge length mm	No. in pack pcs	Part number
36	80	5	6 37 17 107 04 9
40	80	5	6 37 17 108 04 7
60	80	5	6 37 17 109 04 1
80	80	5	6 37 17 110 04 3
100	80	5	6 37 17 111 04 2
120	80	5	6 37 17 112 04 5
150	80	5	6 37 17 113 04 9
180	80	5	6 37 17 114 04 7
220	80	5	6 37 17 115 04 1
240	80	5	6 37 17 116 04 4
36	80	50	6 37 17 107 01 1
40	80	50	6 37 17 108 01 9
60	80	50	6 37 17 109 01 3
80	80	50	6 37 17 110 01 5
100	80	50	6 37 17 111 01 4
120	80	50	6 37 17 112 01 7
150	80	50	6 37 17 113 01 1
180	80	50	6 37 17 114 01 9
220	80	50	6 37 17 115 01 3
240	80	50	6 37 17 116 01 6



SANDING SHEETS, ZIRCONIUM

Excellent sanding capacity on extremely hard surfaces such as varnish (e.g. parquet paint) or metal. The sanding sheet for all floor covering work. Extremely sturdy paper quality thanks to extremely tough full bonding with artificial resins and high-quality zirconium corundum coating. Perforated, for use with perforated sanding pad and dust extraction, hook and loop fastening.

Grain	Edge length mm	No. in pack pcs	Part number
40	80	35	6 37 17 236 01 0
60	80	35	6 37 17 237 01 0
80	80	35	6 37 17 238 01 0



SANDING SET

For the efficient sanding of edge and corner areas and medium-sized surfaces. The alternative to eccentric or random sanders. No kick-back effect at edges. Easy to use, very good sanding capacity. Plastic carrier plate prevents damage and marks on the workpiece.

Scope of supply: 1 large perforated triangular sanding pad (edge length 130 mm), with perforated sanding sheets, 2 each of grit 60, 80, 180.

Edge length mm	Mount	Part number
130	SLP	6 38 06 204 21 0



SANDING SHEETS, PERFORATED

Compatible with large triangular sanding pad with 130 mm edge length.

High sanding capacity, little clogging and long service life guaranteed thanks to corundum abrasive grit and full bonding with artificial resins. For universal use on virtually all materials. Perforated, for use with perforated sanding pad and dust extraction, hook and loop fastening.

Grain	Edge length mm	No. in pack pcs	Part number
60	130	16	6 37 17 293 02 0
80	130	16	6 37 17 294 02 0
120	130	16	6 37 17 295 02 0
180	130	16	6 37 17 296 02 0
240	130	16	6 37 17 297 02 0



SET OF SANDING SHEETS

16 sanding sheets of various grits for the universal use of coarse to fine sanding on virtually all materials. High sanding capacity, little clogging and long service life guaranteed thanks to corundum abrasive grit and full bonding with artificial resins. Content: sanding sheets for large triangular sanding pad (edge length 130 mm), 4 each of grit 60, 80, 120, 180, perforated, for use with and without dust extraction, hook and loop fastening. Better value than buying items separately.

Edge length mm	Part number
130	3 52 22 952 10 0



SANDING SHEETS, ZIRCONIUM

Compatible with large triangular sanding pad with 130 mm edge length.

Excellent sanding capacity on extremely hard surfaces such as varnish (e.g. parquet paint) or metal. The sanding sheet for all floor covering work. Extremely sturdy paper quality thanks to extremely tough full bonding with artificial resins and high-quality zirconium corundum coating. Perforated, for use with perforated sanding pad and dust extraction, hook and loop fastening.

Grain	Edge length mm	No. in pack pcs	Part number
40	130	12	6 37 17 298 01 0
60	130	12	6 37 17 299 01 0
80	130	12	6 37 17 300 01 0

**SANDING SET**

For quickly and cost-effectively sanding medium-sized surfaces. The alternative to eccentric or random sanders. No kick-back effect at edges. Easy to use, very good sanding capacity. Can be used with or without dust extraction. Plastic carrier plate for preventing damage and marks on the workpiece. Round shape, perforated version, hook and loop fastening. Scope of supply: 1 backing pad diameter 115 mm, with perforated sanding sheets, 2 each of grit 60, 80, 180.

Ø mm	Mount	Part number
115	SLP	6 38 06 195 21 0

**SET OF SANDING SHEETS**

16 sanding sheets of various grits for the universal use of coarse to fine sanding on virtually all materials. High sanding capacity, little clogging and long service life guaranteed thanks to corundum abrasive grit and full bonding with artificial resins. Content: sanding sheets, 4 each of grit 60, 80, 120, 180, 115 mm diameter, perforated, for use with and without dust extraction, hook and loop fastening. Better value than buying items separately.

Part number
6 37 17 227 01 0

**SANDING SHEETS**

High sanding capacity, little clogging and long service life guaranteed thanks to corundum abrasive grit and full bonding with artificial resins. For universal use on virtually all materials. 115 mm diameter, perforated, for use with and without dust extraction, hook and loop fastening.

Grain	No. in pack pcs	Part number
40	16	6 37 17 230 02 0
60	16	6 37 17 227 02 0
80	16	6 37 17 228 02 0
120	16	6 37 17 229 01 0
180	16	6 37 17 231 02 0
240	16	6 37 17 232 01 0

**SANDING SHEETS, ZIRCONIUM**

Excellent sanding capacity on extremely hard surfaces such as varnish (e.g. parquet paint) or metal. The sanding sheet for all floor covering work. Extremely sturdy paper quality thanks to extremely tough full bonding with artificial resins and high-quality zirconium corundum coating. 115 mm diameter, perforated, for use with and without dust extraction, hook and loop fastening.

Grain	No. in pack pcs	Part number
40	12	6 37 17 233 01 0
60	12	6 37 17 234 01 0
80	12	6 37 17 235 01 0

**SANDING SHEET SET, ZIRCONIUM**

12 sanding sheets with excellent sanding capacity on extremely hard surfaces such as varnish (e.g. parquet paint) or metal. The sanding sheet for all floor covering work. Extremely sturdy paper quality thanks to extremely tough full bonding with artificial resins and high-quality zirconium corundum coating. Content: sanding sheets, 4 each of grit 40, 60, 80, 115 mm diameter, perforated, for use with and without dust extraction, hook and loop fastening. Better value than buying items separately.

Part number
6 37 17 233 02 0

**BRISTLE FLEECE**

Bristle fleece for cleaning boat decks or cleaning/polishing anti-slip structures.

Edge length mm	No. in pack pcs	Part number
80	2	6 37 23 031 01 0

**FELT POLISHING PAD**

For polishing up metal parts, and for polishing and decorative polishing of stone and stone products. Can also be used to work with gelcoats on boats. Plastic carrier plate for preventing damage and marks on the workpiece. Burnishing compounds for the respective material are available from specialist retailers.

Edge length mm	Mount	No. in pack pcs	Part number
80	SL	2	6 38 06 140 22 0

**FELT POLISHING PAD**

Felt polishing pad for polishing boat decks (gelcoat), chrome, stainless steel, aluminium, copper and copper alloys.

Edge length mm	No. in pack pcs	Part number
80	5	6 37 23 032 01 0

**FELT POLISHING PAD**

Diameter 115 mm, with hook and loop fastening. Versatile in use, for polishing chrome, stainless steel, polycarbonate materials and gelcoat boat decks, for polishing up scratched paint and removing tempering colours on exhaust systems.

No. in pack pcs	Part number
5	6 37 23 036 01 0

**SANDING SHEETS, FOAM BACKING**

for removing scratches from paintwork, gelcoat, acrylic and polycarbonate glazing, lacquers, wood with a clear lacquer, furniture etc. For the best surface quality. 115 mm diameter with foam lamination, hook and loop fastening. Perfect as stage prior to polishing with felt polishing pad and FEIN EXTRA polish.

Grain	No. in pack pcs	Part number
500	5	6 37 17 246 01 0
1000	5	6 37 17 247 01 0

CUTTING, FILING**CARBIDE SAW BLADE**

For cutting out damaged tile joints. Also for cutting slots in plaster, porous concrete and similar building materials and for cleaning and reworking deck joints. Not suited to very hard epoxy resin or cement joints. The cost-effective alternative to diamond tools.

Segmented, ideal for working in corners and on edges without overcutting. Cutting width approx. 2.2 mm.

Ø mm	Mount	No. in pack pcs	Part number
75	SL	1	6 35 02 118 21 0
75	SL	5	6 35 02 118 23 0



Segmented, ideal for working in corners and on edges without overcutting. Cutting width approx. 2.2 mm.

Ø mm	Mount	No. in pack pcs	Part number
90	SLP	1	6 35 02 169 21 0
90	SLP	5	6 35 02 169 23 0



Extra thin version. Cutting width approx. 1.2 mm. Segmented, ideal for working in corners and on edges without overcutting.

Ø mm	Mount	No. in pack pcs	Part number
75	SL	1	6 35 02 125 21 0
75	SL	5	6 35 02 125 23 0



Segmented, ideal for working in corners and on edges without overcutting. Cutting width approx. 2.2 mm.

Ø mm	Mount	No. in pack pcs	Part number
75	SL	1	6 35 02 114 21 0
75	SL	5	6 35 02 114 23 0



Extra thin version. Cutting width approx. 1.2 mm. Segmented, ideal for working in corners and on edges without overcutting.

Ø mm	Mount	No. in pack pcs	Part number
90	SLP	1	6 35 02 170 21 0
90	SLP	5	6 35 02 170 23 0



Segmented, ideal for working in corners and on edges without overcutting. Cutting width approx. 2.2 mm.

Ø mm	Mount	No. in pack pcs	Part number
90	SL	1	6 35 02 166 21 0
90	SL	5	6 35 02 166 23 0



CARBIDE SAW BLADE

For cutting out very narrow marble, epoxy resin and trass joints. Not suited to very hard epoxy resin or cement joints. The cost-effective alternative to diamond tools. Extra thin version. Cutting width approx. 1.2 mm. Segmented, ideal for working in corners and on edges without overcutting.

Mount	No. in pack pcs	Part number
SLM	1	6 39 03 240 21 0
SLM	5	6 39 03 240 23 0



Extra thin version. Cutting width approx. 1.2 mm. Segmented, ideal for working in corners and on edges without overcutting.

Mount	No. in pack pcs	Part number
SLM	1	6 39 03 242 21 0
SLM	5	6 39 03 242 23 0



CARBIDE SAW BLADE

For cutting out marble, epoxy resin and trass joints. Not suited to very hard epoxy resin or cement joints. The cost-effective alternative to diamond tools. Segmented, ideal for working in corners and on edges without overcutting. Cutting width approx. 2.2 mm.

Mount	No. in pack pcs	Part number
SLM	1	6 39 03 241 21 0
SLM	5	6 39 03 241 23 0



Segmented, ideal for working in corners and on edges without overcutting. Cutting width approx. 2.2 mm.

Mount	No. in pack pcs	Part number
SLM	1	6 39 03 243 21 0
SLM	5	6 39 03 243 23 0



DIAMOND-COATED SAW BLADE

For cutting out marble, epoxy resin and trass joints. Excellent service life. Also suited to very hard epoxy resin or cement joints. The right choice for frequent use and challenging jobs. Extra thin version. Cutting width approx. 1.2 mm. Segmented, ideal for working in corners and on edges without overcutting.

Ø mm	Mount	No. in pack pcs	Part number
75	SL	1	6 35 02 216 21 0
75	SL	5	6 35 02 216 23 0



CARBIDE RASP

For rough sanding of fillers, tile adhesive, concrete, stone and wood. Triangular shape, edge length of 80 mm, perforated, can also be used with dust extraction.

Edge length mm	Mount	Part number
80	SL	6 37 31 001 21 0



Extra thin version. Cutting width approx. 1.2 mm. Segmented, ideal for working in corners and on edges without overcutting.

Ø mm	Mount	No. in pack pcs	Part number
90	SLP	1	6 35 02 217 21 0
90	SLP	5	6 35 02 217 23 0



CARBIDE RASP

For rough sanding of fillers, tile adhesive, concrete, stone and wood. For use in very narrow and deep places, in channels, grooves, openings and folds. Also in mould-making, on concave forms and in convex forms and for artistic work. Finger shape, coating on both sides.

Mount	Part number
SLP	6 37 31 002 21 0



CARBIDE RASP

For rough sanding of fillers, tile adhesive, concrete, stone and wood. For particularly good cutting speed and efficient machining of several square metres. Triangular shape, large version, edge length of 110 mm, perforated, can also be used with dust extraction.

Edge length mm	Mount	Part number
110	SLM	6 37 31 006 21 0



TILE JOINT CLEANER

For quickly and cost-effectively cleaning very dirty tile joints. The alternative to a costly, complete renovation. Suitable for all widths of tile joint.

Mount	No. in pack pcs	Part number
SLP	2	6 37 19 011 22 0



CLEANING BLOCK

Rhombus for cleaning the carbide tools and diamond-coated tools.

Part number
6 37 19 007 01 0



CARBIDE FILE

For deburring and filing on CFRP, fibreglass-reinforced plastic, plastics and wood. Especially suitable for cutting out small recesses.

Width mm	Length mm	Mount	Part number
10	30	SL	6 37 06 019 21 0



DIAMOND CLEANING KNIFE

For cleaning mortar flanks before filling them in again. Straight. Width 31 mm, cutting depth 60 mm.

Mount	No. in pack pcs	Part number
SLM	1	6 39 03 237 21 0
SLM	5	6 39 03 237 23 0



STARLOCK TILE WORKING COMBO

3 accessories, especially for renovation and repair jobs in sanitary facilities. When undertaking partial repairs on individual tiles, tile joints can be cut out quickly and cleanly, getting right into the corners and edges without overcutting. Suitable for all FEIN MultiTools and all other common MultiTools with Starlock mounting. Available as a set, offering significant savings over purchasing the items individually. Content: 1 E-Cut universal saw blade (55 x 28 mm), 1 carbide rasp (80 mm), 1 carbide segment saw blade (diameter 75 mm, 2.2 mm).

Mount	Part number
SL	3 52 22 967 07 0



STARLOCKMAX HEATING/SANITARY PROFESSIONAL SET

Accessory kit containing 8 parts with extensive range of accessories, especially for key applications in sanitary repairs. Suitable for FEIN MultiTools with StarlockMax mounting and all other common MultiTools with StarlockMax mounting. Available as a set, offering significant savings over purchasing the items individually. Content: 2 E-Cut universal saw blades (60 x 28 mm, 60 x 44 mm), 1 cutter blade (mushroom-shaped), 1 rigid stopper knife, carbide rasp (1 each of 80 mm, 110 mm), 1 carbide segment saw blade (diameter 90 x 2.2 mm), 1 carbide saw blade (2.2 mm).

Mount	Part number
SLM	3 52 22 967 14 0

CUTTING, SCRAPING



MULTI-FUNCTION KNIFE

For cutting carpet, PVC floors, cardboard, bitumen shingles and roofing fabric. With three cutting surfaces.

Mount	No. in pack pcs	Part number
SL	1	6 39 03 251 21 0
SL	5	6 39 03 251 23 0



FLEXIBLE SCRAPER BLADE

Short version. For removing silicone or acrylic joints in bathrooms and removing stickers.

Mount	Part number
SL	6 39 03 165 21 0



FIXED SCRAPER BLADE

Short version. For removing stubborn old paint, adhesive residues, carpets, tile adhesives and coats of underseal.

Mount	Part number
SL	6 39 03 226 21 0



FIXED SCRAPER BLADE

Long version. For removing stubborn old paint, adhesive residues, carpets, tile adhesives and coats of underseal.

Mount	Part number
SLP	6 39 03 234 21 0



CUTTING BLADE

Mushroom-shaped, for cutting silicone and soft putty material and for separating insulation glass units.

Mount	No. in pack pcs	Part number
SL	5	6 39 03 245 23 0



CUTTING BLADE

For cutting away panelled deck sealant materials quickly and safely. Also ideal for difficult areas such as cabins, rails, gunwales, cleats, and curves.

Blade width mm	Mount	Part number
3	SLP	6 39 03 200 21 0
4	SLP	6 39 03 201 21 0
5	SLP	6 39 03 202 21 0



CUTTING BLADE

Universal blade for virtually all expansion joints. Straight. Width 30 mm, cutting depth 60 mm.

Mount	No. in pack pcs	Part number
SLM	5	6 39 03 236 23 0



CUTTING BLADE

Straight, long shape, for deep joints.

Cutting depth mm	Mount	No. in pack pcs	Part number
65	SLM	5	6 39 03 239 23 0



CUTTING BLADE

Straight, very long shape, for very deep joints.

Cutting depth mm	Mount	No. in pack pcs	Part number
69	SLM	1	6 39 03 238 21 0



STARLOCKMAX GROUT RENEWAL PROFESSIONAL SET

Set of 7 blades for professional renovation of expansion joints down to a depth of 90 mm. Suitable for FEIN MultiTools with StarlockMax mounting and all other common MultiTools with StarlockMax mounting. Available as a set, offering significant savings over purchasing the items individually. Content: 1 cutter blade, straight (65 mm), 1 cutter blade, straight, very long shape (69 mm), 5 universal cutter blades, straight (60 x 30 mm).

Mount	Part number
SLM	3 52 22 967 13 0

OSCILLATING
MULTI-TOOL

GENERAL ACCESSORIES



TABLE-TOP AND DRILL JIGS SUPPORT

Perfect for precision cut-outs: the power tool can be clamped to a table or workbench and the workpiece can be guided safely to the tool. It is also possible to clamp the tool in commercially available drill jigs with a 43 mm collar diameter – the tool can be delivered via the mechanism with millimetre precision. Suited to FEIN MULTIMASTER and FEIN SuperCut. Suitable for all FEIN MultiTools with a mechanical interface.

Part number
9 26 02 083 01 0



DUST EXTRACTION SET

For effective removal of dust combined with maximum flexibility. Permanent connection to the tool for a secure hold in all work situations. Suction hose can be rotated freely on the tool so it can be adapted perfectly to the work situation. Antistatic – in combination with FEIN Dustex dust extractors and anti-static suction hose (optional). 35 mm diameter suction hose, standard for the most common vacuum cleaner systems. Scope of supply: 1 extraction unit, 2 perforated sanding pads (edge length 80 mm), corundum sanding sheets, perforated (60, 80 and 120 grit, 5 each). Suitable for FEIN SuperCut (FSC 500 QSL, AFSC 18 QSL) and FEIN MULTIMASTER (FMM 350 QSL, AFMM 18 QSL).

Part number
9 26 02 102 00 0



DUST EXTRACTION SET

2 perforated sanding pads; perforated sanding sheets, 5 each of grit 60, 80, 120; 1 extractor hood with suction pipe; 1 adapter; 2 felt seals. For MULTIMASTER FMM 350 Q / QSL.

Part number
9 26 02 091 00 0



DUST EXTRACTION SET

2 sanding pads, perforated; sanding sheets, perforated, 5 each of grit 60, 80, 120; 1 extractor hood with suction pipe; 2 hose sockets for hose connection with a diameter of 27 and 32 mm and 2 adapters for connecting to the most common household vacuum cleaners. FMM 250 / 250 Q, FMT 250 / 250Q, FMT 250 SL / 250 QSL

Part number
9 26 02 092 00 0



DUST EXTRACTION SET

2 x perforated sanding pads, perforated sanding sheets, (5 each of grit 60, 80, 120), 1 x extractor hood with suction pipe. FSC 500 QSL

Part number
9 26 02 095 00 0



DEVICE FOR DUST EXTRACT

For cutting and sawing applications with diamond-coated tools or E-Cut saw blades. Suitable for FEIN SuperCut FSC 500 QSL and AFSC 18 QSL.

Part number
3 21 33 021 01 0



ADDITIONAL HANDLE

For improved handling of the FSC 500 QSL during long periods of continuous use. Can also be used in conjunction with the extraction device 3 21 33 021 01 0.

Part number
3 21 19 148 02 0



ADAPTER FOR FEIN OSCILLATOR (UP TO 2004)

Spacer ring and clamping screw for older FEIN MULTIMASTER models MSx 636, MSx 636-1 and MSxe 636 II. Up to 40 % improved torque transfer thanks to positive-fit connection to Starlock mounting on accessory side. Flat clamping screw for working flush with the surface.

Part number
3 52 22 927 05 0



CUTTING PASTE

Lubricating agents for working on sheet metals.

Part number
3 21 32 020 12 9



WORK GLOVES

Vibration-attenuating, certified according to EN 388/420, EN ISO 10819, EEC No. 0200, No. in pack 1 pair.

Size	Part number
9 L	3 21 73 003 00 3
10 XL	3 21 73 004 00 1
11 XXL	3 21 73 005 00 5



TOOL CASE

Plastic, inner dimensions: 470 x 275 x 116 mm

Part number
3 39 01 118 01 0



PLASTIC BOX

Box insert with lockable lid for small parts and accessories, suitable for tool box 3 39 01 118 01 0, max 5 items/box.

Part number
3 39 01 119 00 0

18 V BATTERY



QUICK CHARGER ALG 80 BC

Bluetooth® connectivity for connecting to a mobile end device and for use with the my.FEIN app. Shows the current charge state and the number of charge cycles to date on your smartphone or tablet. Provides notification when the battery is fully charged. Short charge times thanks to high charge current of 8 amps and process-controlled charge management. Large LED display with charge indicator and USB port for mobile charging of small electrical devices. For all FEIN Li-ion batteries. Charge times (80 % of max. capacity): 12 and 18 V / 3 Ah: 31 min., 12 and 18 V / 6 Ah: 38 min., 18 V / 5.2 Ah: 33 min.

Part number
9 26 04 210 01 0



BATTERY PACK

Li-ion battery with charge status indicator and FEIN SafetyCell technology. Protects the battery and tool from overload, overheating and total discharge. Can be used with all FEIN 18 V cordless tools.

Current/Voltages V	Capacity Ah	Weight kg	Part number
18	6	0,7	9 26 04 175 02 0
18	3	0,45	9 26 04 182 02 0

**BATTERY STARTER SET**

2 x Li-ion batteries with ALG 80 BC rapid charger. Bluetooth® connectivity for connecting to a mobile end device and for use with the my.FEIN app. Shows the current charge state and the number of charge cycles to date on your smartphone or tablet. Provides notification when the battery is fully charged. Short charge times thanks to high charge current of 8 amps and process-controlled charge management. Large LED display with charge indicator and USB port for mobile charging of small electrical devices. For all FEIN Li-ion batteries. Charge times (80 % of max. capacity): 12 and 18 V / 3 Ah: 31 min., 12 and 18 V / 6 Ah: 38 min., 18 V / 5.2 Ah: 33 min.

Current/Voltages V	Capacity Ah	Part number
18	6	9 26 04 323 01 0
18	3	9 26 04 324 01 0

12 V BATTERY**QUICK CHARGER ALG 80**

The high charge current of 8 amps and process-controlled charge management make for short charge times. Large LED with charge state indicator and USB port for the mobile charging of small electronic devices, such as smartphones or tablets. For all FEIN Li-ion batteries. Charge times (80 % of max. capacity): 12 and 18 V / 3 Ah: 31 min., 12 and 18 V / 6 Ah: 38 min., 18 V / 5.2 Ah: 33 min.

Part number
9 26 04 180 01 0

**BATTERY PACK**

Li-ion battery with charge status indicator and FEIN SafetyCell technology. Protects the battery and tool from overload, overheating and total discharge. Can be used with all FEIN 12 V cordless tools and 18 V cordless tools with MultiVolt interface.

Current/Voltages V	Capacity Ah	Weight kg	Part number
12	6	0,45	9 26 04 184 02 0
12	3	0,25	9 26 04 183 02 0

**BATTERY STARTER SET**

2 x Li-ion batteries with ALG 80 rapid charger. The high charge current of 8 amps and process-controlled charge management make for short charge times. Large LED with charge state indicator and USB port for the mobile charging of small electronic devices, such as smartphones or tablets. Charge times (80 % of max. capacity): 12 and 18 V / 3 Ah: 31 min., 12 and 18 V / 6 Ah: 38 min.

Current/Voltages V	Capacity Ah	Part number
12	6	9 26 04 327 01 0
12	3	9 26 04 326 01 0

ACCESSORY SETS**BEST OF E-CUT STARLOCK WOOD & METAL**

6 E-Cut plunge-cut saw blades for sawing in wood and metal. Suitable for all FEIN MultiTools and all other common MultiTools on the market. Available as a set, offering significant savings over purchasing the items individually. Content: E-Cut long-life saw blades (2 each of 50 x 35 mm, 50 x 65 mm), E-Cut universal saw blade (1 each of 55 x 28 mm, 55 x 44 mm).

Mount	Part number
SL	3 52 22 967 01 0

**BEST OF STARLOCK SANDING**

Accessory kit containing 63 parts for sanding in corners and on edges. Suitable for all FEIN MultiTools and all other common MultiTools with Starlock mounting. Available as a set, offering significant savings over purchasing the items individually. Content: 2 sanding pads, unperforated (80 mm), 1 sanding finger, sanding sheets (10 each of grit 60, 80, 120) for sanding pad and sanding finger.

Mount	Part number
SL	3 52 22 967 04 0

**BEST OF STARLOCK METAL**

6 saw blades, especially for machining hardened and non-hardened metals. Suitable for all FEIN MultiTools and all other common MultiTools with Starlock mounting. Available as a set, offering significant savings over purchasing the items individually. Content: 1 E-Cut CarbidePRO saw blade (40 x 32 mm), E-Cut long-life saw blades (1 each of 50 x 35 mm and 50 x 50 mm), 1 E-Cut universal saw blade (55 x 44 mm), 1 E-Cut fine saw blade (50 x 30 mm), 1 complete HSS segment saw blade (diameter 85 mm).

Mount	Part number
SL	3 52 22 967 02 0

**BEST OF STARLOCK RENOVATION**

Accessory kit containing 26 parts for upcoming renovation work. Suitable for all FEIN MultiTools and all other common MultiTools with Starlock mounting. Available as a set, offering significant savings over purchasing the items individually. Content: 6 E-Cut long-life saw blades (2 each of 50 x 35 mm, 50 x 50 mm, 50 x 65 mm), 1 carbide rasp (80 mm), 1 carbide segment saw blade (diameter 75 mm, 2,2 mm), 1 rigid stopper knife, 1 cutter blade, (mushroom-shaped), 1 sanding pad, unperforated (80 mm), sanding sheets (5 each of grit 60, 80, 120).

Mount	Part number
SL	3 52 22 967 06 0

**STARLOCK TILE WORKING COMBO**

3 accessories, especially for renovation and repair jobs in sanitary facilities. When undertaking partial repairs on individual tiles, tile joints can be cut out quickly and cleanly, getting right into the corners and edges without overcutting. Suitable for all FEIN MultiTools and all other common MultiTools with Starlock mounting. Available as a set, offering significant savings over purchasing the items individually. Content: 1 E-Cut universal saw blade (55 x 28 mm), 1 carbide rasp (80 mm), 1 carbide segment saw blade (diameter 75 mm, 2,2 mm).

Mount	Part number
SL	3 52 22 967 07 0

**STARLOCK RENOVATION COMBO**

3 accessories, especially for renovation work on flooring. Suitable for all FEIN MultiTools and all other common MultiTools with Starlock mounting. Available as a set, offering significant savings over purchasing the items individually. Content: 1 carbide segment saw blade (diameter 85 mm), 1 E-Cut long-life saw blade (50 x 35 mm), 1 rigid stopper knife.

Mount	Part number
SL	3 52 22 967 11 0

**STARLOCK MINI CUT COMBO**

3 accessories, ideal for cutting smaller recesses and working in tight spots, e.g. for numerous installation jobs, switch installation, model-building and more. Suitable for all FEIN MultiTools and all other common MultiTools with Starlock mounting. Available as a set, offering significant savings over purchasing the items individually. Content: E-Cut long-life saw blades (2 of 30 x 10 mm, 35 x 20 mm), 1 carbide file (30 x 10 mm).

Mount	Part number
SL	3 52 22 967 09 0

**STARLOCK WOOD & METAL E-CUT COMBO**

3 E-Cut plunge-cut saw blades for sawing in wood and metal. Suitable for all FEIN MultiTools and all other common MultiTools with Starlock mounting. Available as a set, offering significant savings over purchasing the items individually. Content: 2 E-Cut long-life saw blades (50 x 35 mm, 50 x 65 mm), 1 E-Cut universal saw blade (55 x 44 mm).

Mount	Part number
SL	3 52 22 967 10 0



STARLOCK WOOD E-CUT COMBO

3 E-Cut plunge-cut saw blades for precise sawing in wooden materials. Suitable for all FEIN MultiTools and all other common MultiTools with Starlock mounting. Available as a set, offering significant savings over purchasing the items individually. Content: 1 E-Cut standard saw blade, curved (50 x 50 mm), E-Cut precision BIM saw blade (1 each of 50 x 35 mm, 50 x 65 mm).

Mount	Part number
SL	3 52 22 967 08 0



BEST OF E-CUT STARLOCKPLUS WOOD & METAL

6 E-Cut plunge-cut saw blades for sawing in wood and metal. Suitable for all FEIN MultiTools and all other common MultiTools with Starlock-Plus and StarlockMax mounting. Available as a set, offering significant savings over purchasing the items individually. Content: E-Cut long-life saw blades (2 each of 50 x 35 mm, 50 x 65 mm), E-Cut universal saw blade (1 each of 60 x 28 mm, 60 x 44 mm).

Mount	Part number
SLP	3 52 22 967 03 0



BEST OF E-CUT STARLOCKMAX WOOD & METAL

6 extra long E-Cut plunge-cut saw blades for large plunge depths and effective working in wood and metal. Suitable for FEIN MultiTools with StarlockMax mounting and all other common MultiTools with StarlockMax mounting. Available as a set, offering significant savings over purchasing the items individually. Content: E-Cut long-life saw blades (2 each of 78 x 32 mm, 78 x 42 mm), 2 E-Cut long-life saw blades (90 x 32 mm).

Mount	Part number
SLM	3 52 22 967 05 0



STARLOCKMAX HEATING/SANITARY PROFESSIONAL SET

Accessory kit containing 8 parts with extensive range of accessories, especially for key applications in sanitary repairs. Suitable for FEIN MultiTools with StarlockMax mounting and all other common MultiTools with StarlockMax mounting. Available as a set, offering significant savings over purchasing the items individually. Content: 2 E-Cut universal saw blades (60 x 28 mm, 60 x 44 mm), 1 cutter blade (mushroom-shaped), 1 rigid stopper knife, carbide rasp (1 each of 80 mm, 110 mm), 1 carbide segment saw blade (diameter 90 x 2.2 mm), 1 carbide saw blade (2.2 mm).

Mount	Part number
SLM	3 52 22 967 14 0



STARLOCKMAX GROUT RENEWAL PROFESSIONAL SET

Set of 7 blades for professional renovation of expansion joints down to a depth of 90 mm. Suitable for FEIN MultiTools with StarlockMax mounting and all other common MultiTools with StarlockMax mounting. Available as a set, offering significant savings over purchasing the items individually. Content: 1 cutter blade, straight (65 mm), 1 cutter blade, straight, very long shape (69 mm), 5 universal cutter blades, straight (60 x 30 mm).

Mount	Part number
SLM	3 52 22 967 13 0



STARLOCKMAX INTERIOR WORK PROFESSIONAL SET

Accessory kit containing 45 parts with extensive range of saw blades for fast, precise sawing in all kinds of installation work. Suitable for FEIN MultiTools with StarlockMax mounting and all other common MultiTools with StarlockMax mounting. Available as a set, offering significant savings over purchasing the items individually. Content: 8 E-Cut long-life saw blades (1 set of 34 x 20 mm, 2 each of 50 x 35 mm and 50 x 65 mm, 1 each of 78 x 32 mm, 78 x 42 mm and 90 x 32 mm), E-Cut precision BIM saw blade (1 each of 50 x 35 mm, 50 x 65 mm), 1 HSS circular saw blade (diameter 100 mm), 1 depth stop, 1 rigid stopper knife, long, 1 extraction device, anti-static, 1 sanding pad, perforated (80 mm), sanding sheets, perforated (10 each of grit 60, 80, 120).

Mount	Part number
SLM	3 52 22 967 12 0



SAWING



SAW BLADES

HSS, with fine teeth for precise cutting. Universal use on sheet metal of up to approx. 1 mm, can be doubled in plastics.

Ø mm	No. in pack pcs	Part number
63	2	6 35 02 102 01 6
63	5	6 35 02 102 07 0
80	2	6 35 02 103 01 0
80	5	6 35 02 103 05 0



SAW BLADES

HSS, cranked, countersunk clamping screw for flush working.

Ø mm	No. in pack pcs	Part number
85	1	6 35 02 177 01 0
85	5	6 35 02 177 05 0
100	1	6 35 02 178 01 0
100	5	6 35 02 178 05 0



SEGMENT SAW BLADE

HSS, cranked, countersunk clamping screw for flush working.

Ø mm	No. in pack pcs	Part number
100	1	6 35 02 196 01 0
100	5	6 35 02 196 05 0



BEST OF E-CUT ACCESSORY SET

Includes 6 different E-Cut saw blades. Content: E-Cut Universal (1x 28 mm and 1x 44 mm wide), 2x E-Cut Long-Life 35 mm wide, 2x E-Cut Long-Life 65 mm wide, in practical plastic storage box.

Part number
6 35 02 147 12 0



E-CUT LONG-LIFE SAW BLADES

Bi-metallic teeth, stepped, high cutting speed. Extremely durable and robust. For hardwood, softwood and all other wooden materials - including those with nails. Also perfectly suited to plastics and plasterboard. Length 78 mm, form 162

Width mm	No. in pack pcs	Part number
32	1	6 35 02 162 01 0
32	5	6 35 02 162 02 0
32	25	6 35 02 162 03 0



Length 78 mm, form 163

Width mm	No. in pack pcs	Part number
42	1	6 35 02 163 01 0
42	5	6 35 02 163 02 0
42	25	6 35 02 163 03 0



Length 50 mm, form 164

Width mm	No. in pack pcs	Part number
35	1	6 35 02 164 01 0
35	5	6 35 02 164 02 0
35	25	6 35 02 164 03 0



Length 50 mm, form 165

Width mm	No. in pack pcs	Part number
65	1	6 35 02 165 01 0
65	5	6 35 02 165 02 0
65	25	6 35 02 165 03 0



E-CUT STANDARD SAW BLADES

Crossed toothing for all wood, plasterboard, and plastics jobs. Length 78 mm, form 123

Width mm	No. in pack pcs	Part number
32	1	6 35 02 123 01 8
32	5	6 35 02 123 04 6
32	25	6 35 02 123 03 0



Length 78 mm, form 124

Width mm	No. in pack pcs	Part number
42	1	6 35 02 124 01 6
42	5	6 35 02 124 04 4
42	25	6 35 02 124 03 8



Length 50 mm, form 135

Width mm	No. in pack pcs	Part number
35	1	6 35 02 135 01 9
35	5	6 35 02 135 03 1
35	25	6 35 02 135 02 5



Length 50 mm, form 136

Width mm	No. in pack pcs	Part number
65	1	6 35 02 136 01 2
65	5	6 35 02 136 03 4
65	25	6 35 02 136 02 8



E-CUT PRECISION SAW BLADES

Double-row original Japan toothing, for top-precision cuts, and clean cutting edges even freely by hand Length 50 mm, form 119

Width mm	No. in pack pcs	Part number
35	1	6 35 02 119 01 0
35	5	6 35 02 119 04 8
35	25	6 35 02 119 03 2



E-CUT PRECISION SAW BLADE

Double-row original Japan toothing, for top-precision cuts, and clean cutting edges even freely by hand Length 50 mm, form 235

Width mm	No. in pack pcs	Part number
50	1	6 35 02 235 01 0
50	5	6 35 02 235 02 0
50	25	6 35 02 235 03 0



Length 50 mm, form 122

Width mm	No. in pack pcs	Part number
65	1	6 35 02 122 01 4
65	5	6 35 02 122 04 2
65	25	6 35 02 122 03 6

**E-CUT PRECISION BIM SAW BLADE**

Bimetal with double-row Japan teeth for all wooden materials, plasterboard and soft plastics. Improved tool life and robustness. The fastest cutting speed and maximum precision. Length 50 mm, form 209

Width mm	No. in pack pcs	Part number
35	1	6 35 02 209 01 0
35	5	6 35 02 209 02 0
35	25	6 35 02 209 03 0



Length 50 mm, form 210

Width mm	No. in pack pcs	Part number
50	1	6 35 02 234 01 0
50	5	6 35 02 234 02 0
50	25	6 35 02 234 03 0



Length 50 mm, form 212

Width mm	No. in pack pcs	Part number
65	1	6 35 02 212 01 0
65	5	6 35 02 212 02 0
65	25	6 35 02 212 03 0

**E-CUT UNIVERSAL SAW BLADES**

Bi-metal teeth, cranked, also suitable for radii, high speed cut, sheet metal (400 N/mm²) up to about 2 mm and plastics, aluminium profiles, copper pipes, wood, plasterboard, and almost all plastics. Length 60 mm, form 147

Width mm	No. in pack pcs	Part number
28	1	6 35 02 147 01 5
28	5	6 35 02 147 02 1
28	25	6 35 02 147 03 7



Length 60 mm, form 148

Width mm	No. in pack pcs	Part number
44	1	6 35 02 148 01 3
44	5	6 35 02 148 02 9
44	25	6 35 02 148 03 5

**HSS SAW BLADE WOOD**

Ideal for long, straight cuts and for cutting out laid parquet or laminate flooring. Without depth stop

Width mm	No. in pack pcs	Part number
100	1	6 35 02 179 01 0

**HSS SAW BLADE WOOD**

Ideal for long, straight cuts and for cutting out laid parquet or laminate flooring. With depth stop

Width mm	No. in pack pcs	Part number
100	1	6 35 02 179 02 0

**DEPTH STOP**

Depth stop for all saw blades. For accurate working at depth. Effective protection for blade and workpiece. Contents: 1 adapter for attachment to the machine. 1 depth stop, 1 depth-adjustable guide block. Can only be used with (A)MM 500 / 700.

Part number

3 21 27 069 01 0

**CARBIDE SAW BLADE WITH OPEN TEETH**

For perfect, clean cut edges in carbon fibre-reinforced plastic/fibreglass-reinforced plastic materials without delamination. Distortion-free, long, straight cuts at high cutting speed. Can also be used with depth stop.

Ø mm	Cutting width mm	Part number
105	1,2	6 35 02 189 01 0

**DIAMOND SEGMENT SAW BLADE WITH OPEN TEETH**

For perfect, clean cut edges in carbon fibre-reinforced plastic/fibreglass-reinforced plastic materials without delamination. Distortion-free, long, straight cuts at very high cutting speed. Diamond coating for outstanding service life. Can also be used with depth stop.

Ø mm	Cutting width mm	Part number
105	1,2	6 35 02 190 01 0



Gentle sawing with perfect, clean cut edges in carbon fibre-reinforced plastic/fibreglass-reinforced plastic materials without delamination. Particularly well suited to precise cut-outs and short cuts. Diamond coating for outstanding service life. Precise working into the corners and on edges. Can also be used with depth stop.

Width mm	Length mm	Part number
42	60	6 35 02 195 01 0

**SEGMENT SAW BLADE**

depressed, for removing panes of insulating glass installed on a putty bed, pack of 2

Part number

6 39 03 166 01 6

REMOVE GROUTS**CARBIDE SAW BLADE**

In comparison with the diamond version, the price is lower and the service life shorter. Extra thin version, cutting line approx. 1.2 mm, not suited to very hard epoxy resin or cement joints. Also suited to reworking deck joints.

Ø mm	No. in pack pcs	Part number
80	1	6 35 02 155 01 0



Stepped, cutting line approx. 2.2 mm, standard for all marble, epoxy resin and concrete trass joints.

Ø mm	No. in pack pcs	Part number
80	1	6 35 02 156 01 0



CARBIDE SEGMENT BLADE

In comparison with the diamond version, the price is lower and the service life shorter. For corners and radii and for working without overcutting, cutting line approx. 2.2 mm for all marble and epoxy resin joints.

No. in pack pcs	Part number
1	6 39 03 225 01 0
5	6 39 03 225 02 0



DIAMOND-COATED SAW BLADE

Cutting line approx. 2.2 mm, standard design for all marble, epoxy resins and cement trass mortar.

Ø mm	No. in pack pcs	Part number
80	1	6 35 02 115 01 1
80	5	6 35 02 115 03 0



Cutting line approx. 1.2 mm for extremely thin marble mortar joints. Not suitable for epoxy resin and cement trass mortar.

Ø mm	No. in pack pcs	Part number
80	1	6 35 02 116 01 4
80	5	6 35 02 116 02 0



SEGMENT BLADE

Diamond-coated, also for corners and radii and for working without overcutting. Cutting line approx. 2.2 mm, standard design for all marble, epoxy resins and cement trass mortar.

No. in pack pcs	Part number
1	6 39 03 162 01 7
5	6 39 03 162 03 0



Cutting line approx. 1.2 mm, for extremely narrow marble joints. Cutting depth max. 10 mm. Not suitable for epoxy resin or trass cement joints.

No. in pack pcs	Part number
1	6 39 03 196 01 3
5	6 39 03 196 02 0



CLEANING BLOCK

Rhombus for cleaning the carbide tools and diamond-coated tools.

Part number
6 37 19 007 01 0



CUTTING BLADE

Straight shape. Universal blade for almost all expansion sealants. Pack of 5

Part number
6 39 03 117 01 5



CUTTING BLADE

Straight, long, for very deep joints, pack of 5

Part number
6 39 03 116 01 1



SEGMENT BLADE

Segment form for V-cut from outside and for cuts in corners, 2-pack

Total length mm	Cut length mm	Part number
73	30	6 39 03 132 01 0

SCRAPING



SCRAPER BLADE

for removing floor covering remains, underseal and residual bonding material, etc., pack of 2

Length mm	No. in pack pcs	Part number
64	2	6 39 03 206 01 8
72	2	6 39 03 227 01 0

CUTTING



CUTTING BLADE

Mushroom-shaped, pack of 5, For cutting elastic silicon or acrylic connecting joints.

Part number
6 39 03 128 01 2

GENERAL ACCESSORIES

SYSTEMER INSERT FOR AFSC 18 Q

Part number
3 39 04 542 00 0



DEVICE FOR DUST EXTRACT

FSC 2.0 X
For jobs with diamond-coated tools; tool-free mount.
Hose connection Ø 32 mm.

Part number
9 26 02 075 01 8



DUST EXTRACTION SET

For all sanding and rasping jobs with triangular sanding pad and carbide rasp. incl. 2 sanding pads, perforated; 5 of each type of sanding sheet, perforated, grit 60, 80, and 120; 1 extractor hood with suction tube; 2 hose nozzles for hose connection Ø 27 and 32 mm plus 2 adapters for connection to the most common domestic vacuum cleaners.
For FSC 2.0 Q.

Part number
9 26 02 074 01 4

**WORK GLOVES**

Vibration-attenuating, certified according to EN 388/420, EN ISO 10819, EEC No. 0200, No. in pack 1 pair.

Size	Part number
9 L	3 21 73 003 00 3
10 XL	3 21 73 004 00 1
11 XXL	3 21 73 005 00 5

**BAIL HANDLE**

To reduce the vibrations and for better handling of the FEIN SuperCut during longer jobs. Can be used in connection with the dust extraction device 9 26 02 084 01 0.

Part number
3 21 19 116 01 1

**ADAPTER FOR FEIN SUPERCUT WITHOUT QUICKIN**

Needed to hold accessories with an 8-star holder (e.g. rasps, sanding and polishing pads).

Part number
3 06 05 114 01 1

**ADAPTER FOR FEIN SUPERCUT WITHOUT QUICKIN**

to mount Starlock accessories on older FEIN SuperCut units without QuickIN tool mounting (FSC 1.6, FSC 1.7). Adapter plus clamping screw.

Part number
3 52 22 952 04 0

**ADAPTER FOR FEIN SUPERCUT WITH QUICKIN**

Needed to hold accessories with an 8-star holder (e.g. rasps, sanding and polishing pads).

Part number
6 37 33 005 01 0

**ADAPTER FOR FEIN SUPERCUT WITH QUICKIN**

to mount Starlock accessories on older FEIN SuperCut units with QuickIN tool mounting (FSC 1.6 Q, FSC 1.7 Q, FSC 2.0 Q, AFSC 1.7 Q and AFSC 18). Adapter plus clamping screw.

Part number
3 52 22 952 05 0

**CUTTING PASTE**

Lubricating agents for working on sheet metals.

Part number
3 21 32 020 12 9

ACCESSORY SETS**ACCESSORY SET FOR INTERIOR CONSTRUCTION WORK WITH WOOD**

Additional purchase for professional set for interior construction work with wood, consisting of: 1 HSS saw blade for wood (form 153), 4 E-Cut long-life saw blades (form 162, 163 and 164, 165), 4 E-Cut precision saw blades (form 119, 120 and 121, 122), 2 E-Cut universal saw blades (form 147, 148), 1 depth stop, 1 sanding pad, 5 each of sanding sheets, grain 80, 120, 180, 1 adapter and 2 tensioning elements

Part number
6 39 03 167 66 0

**ACCESSORY SET FOR REPAIRING/REPLACING WINDOWS**

Additional purchase for professional set for repairing/replacing windows, consisting of: 1 HSS saw blade, stepped (form 137), 1 HSS saw blade for wood (form 153), 1 E-Cut long-life saw blade (form 163), 2 E-Cut universal saw blades (form 147, 148), 1 segment saw blade (form 166), 1 cutter blade, mushroom-shaped (form 128), 1 depth stop, 1 sanding pad, 5 each of sanding sheets, grain 80, 120, 180, 1 adapter and 2 tensioning elements

Part number
6 39 03 167 67 0



CORDLESS MULTIMASTER AMM 700 1.7 Q SELECT	CORDLESS MULTIMASTER AMM 700 1.7 Q AUTOGLAS	MULTIMASTER MM 700 1.7 BASIC	MULTIMASTER MM 700 1.7 Q BASIC	MULTIMASTER MM 700 1.7 Q AUTOGLAS	MULTIMASTER MM 700 1.7 Q BUS & TRUCK	MOTLX 6-25
Our best oscillating cordless MULTIMASTER for the automotive sector.	Our best oscillating cordless MULTIMASTER for the automotive sector including an extensive set of accessories extensive for cutting out windows and work on the car body.	Our best oscillating MULTIMASTER for the automotive sector with extra flat gearbox head for working in tight spots.	Our best oscillating MULTIMASTER for the automotive sector.	Our best oscillating MULTIMASTER for the automotive sector including an extensive set of accessories extensive for cutting out windows and work on the car body.	Our best oscillating MULTIMASTER including an extensive set of accessories for work on cars and commercial vehicles.	The powerful pneumatic oscillator for cargo.

PAGE		247	247	248	248	248	249	249
Input	W			450	450	450	450	
Battery voltage	V	18	18					
Battery compatibility		Li-ion/HighPower Li-ion	Li-ion/HighPower Li-ion					
Battery interface		MultiVolt	MultiVolt					
Oscillations	rpm	10,000 - 19,500	10,000 - 19,500	10,000 - 19,500	10,000 - 19,500	10,000 - 19,500	10,000 - 19,500	20,000
Tool Holder		Hexagon	Hexagon	Hexagon	Hexagon	Hexagon	Hexagon	Hexagon
Tool change		QuickIN	QuickIN	Manual with screw, hexagon socket	QuickIN	QuickIN	QuickIN	Manual with screw, hexagon socket
Amplitude		2 x 1,7°	2 x 1,7°	2 x 1,7°	2 x 1,7°	2 x 1,7°	2 x 1,7°	2 x 1,6°
Weight according to EPTA	kg			1,45	1,65	1,65	1,65	0,9
Weight with battery	kg		1,8					
Weight without storage battery	kg	1,1	1,1					

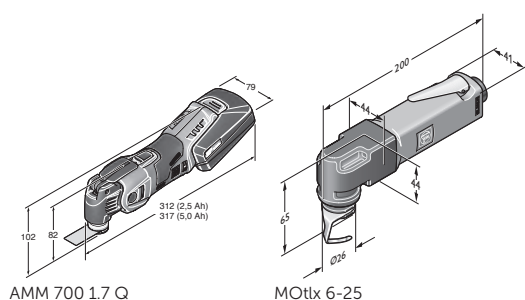

AMM 700 1.7 Q

MOTLX 6-25

CORDLESS MULTIMASTER AMM 700 1.7 Q SELECT



SUPPLIED

1 protective cover for tool changes,
1 sharpening stone (6 37 19 010 01 4),
1 plastic carrying case

For accessories, see page 250

Our best oscillating cordless MULTIMASTER for the automotive sector.

Battery voltage	V	18
Battery compatibility		Li-ion/ HighPower Li-ion
Battery interface		MultiVolt
Oscillations	rpm	10,000 - 19,500
Tool Holder		Hexagon
Tool change		QuickIN
Amplitude		2 x 1,7°
Weight without storage battery	kg	1,1

Part number	7 129 35 61 00 0
EAN	4014586893198

FEIN BENEFITS

- + Designed for cutting out windows and work on the car body.
- + Anti-vibration system: continuously safe and pleasant working thanks to minimal vibrations and outstanding noise insulation.
- + QuickIN: tool changes in less than 3 seconds thanks to the patented tool-free FEIN rapid clamping system.
- + Hexagonal tool holder for optimum torque transfer.
- + 18 V FEIN PowerDrive motor: very powerful and virtually wear-free, brushless motor offering great efficiency, ability to handle extreme loads and a long service life.
- + Tacho generator: constant speeds even under load and infinitely variable electronic speed control.
- + Metal gearbox: ability to withstand high loading and outstanding service life because all the gearbox parts are made from metal.
- + SafetyCell technology: perfect protection against overload, overheating and total discharge thanks to Li-ion batteries with individual cell monitoring.
- + The battery charge can be read off the battery.

CORDLESS MULTIMASTER AMM 700 1.7 Q AUTOGLAS



SUPPLIED

1 protective cover for tool changes,
1 Straight cutter blade, Z-bend,
toothed (form 081), 1 each U-shaped
cutter blade, reinforced design
(forms 157 and 111), 1 L-shaped
cutter blade, toothed (form 209),
2 L-shaped cutter blades, toothed
(form 208), 2 U-shaped cutter
blades, reinforced design, toothed
(form 212), 3 L-shaped cutter blades,
toothed (form 207), 1 Straight cutter
blade, Z-bend, with adjustable roller
stop (form 143), 1 sharpening stone
(6 37 19 010 01 4), 2 Li-ion battery
packs (18 V / 6 Ah), 1 rapid charger
ALG 80, 1 plastic carrying case

For accessories, see page 250

Our best oscillating cordless MULTIMASTER for the automotive sector including an extensive set of accessories extensive for cutting out windows and work on the car body.

Battery voltage	V	18
Battery capacity	Ah	6
Battery compatibility		Li-ion/ HighPower Li-ion
Battery interface		MultiVolt
Oscillations	rpm	10,000 - 19,500
Tool Holder		Hexagon
Tool change		QuickIN
Amplitude		2 x 1,7°
Weight with battery	kg	1,8
Weight without storage battery	kg	1,1

Part number	7 129 35 62 00 0
EAN	4014586893211

FEIN BENEFITS

- + Designed for cutting out windows and work on the car body.
- + Anti-vibration system: continuously safe and pleasant working thanks to minimal vibrations and outstanding noise insulation.
- + QuickIN: tool changes in less than 3 seconds thanks to the patented tool-free FEIN rapid clamping system.
- + Hexagonal tool holder for optimum torque transfer.
- + 18 V FEIN PowerDrive motor: very powerful and virtually wear-free, brushless motor offering great efficiency, ability to handle extreme loads and a long service life.
- + Tacho generator: constant speeds even under load and infinitely variable electronic speed control.
- + Metal gearbox: ability to withstand high loading and outstanding service life because all the gearbox parts are made from metal.
- + SafetyCell technology: perfect protection against overload, overheating and total discharge thanks to Li-ion batteries with individual cell monitoring.
- + The battery charge can be read off the battery.

MULTIMASTER MM 700 1.7 BASIC



SUPPLIED

1 key, 1 sharpening stone
(6 37 19 010 01 4),
1 Mounting bolt (3 30 01 039 01 7),
1 plastic carrying case

For accessories, see page 250

Our best oscillating MULTIMASTER for the automotive sector with extra flat gearbox head for working in tight spots.

Input	W	450
Output	W	250
Oscillations	rpm	10,000 - 19,500
Tool Holder		Hexagon
Tool change		Manual with screw, hexagon socket
Amplitude		2 x 1,7°
Cable with plug	m	5
Weight according to EPTA	kg	1,45

Part number	7 229 69 61 00 0
EAN	4014586893556

FEIN BENEFITS

- + Designed for cutting out windows and work on the car body.
- + Anti-vibration system: continuously safe and pleasant working thanks to minimal vibrations and outstanding noise insulation.
- + Hexagonal tool holder for optimum torque transfer.
- + 450 W FEIN high-power motor: high-power motor with a high copper content, which is suited to continuous use and overload for maximum cutting speed and the most rapid work progress.
- + Tacho generator: constant speeds even under load and infinitely variable electronic speed control.
- + Metal gearbox: ability to withstand high loading and outstanding service life because all the gearbox parts are made from metal.
- + Industrial cable: large working radius thanks to finely stranded 5 metre rubber cable of industrial quality.

MULTIMASTER MM 700 1.7 Q BASIC



SUPPLIED

1 protective cover for tool changes,
1 sharpening stone (6 37 19 010 01 4),
1 plastic carrying case

For accessories, see page 250

Our best oscillating MULTIMASTER for the automotive sector.

Input	W	450
Output	W	250
Oscillations	rpm	10,000 - 19,500
Tool Holder		Hexagon
Tool change		QuickIN
Amplitude		2 x 1,7°
Cable with plug	m	5
Weight according to EPTA	kg	1,65

Part number	7 229 70 61 00 0
EAN	4014586893594

FEIN BENEFITS

- + Designed for cutting out windows and work on the car body.
- + Anti-vibration system: continuously safe and pleasant working thanks to minimal vibrations and outstanding noise insulation.
- + QuickIN: tool changes in less than 3 seconds thanks to the patented tool-free FEIN rapid clamping system.
- + Hexagonal tool holder for optimum torque transfer.
- + 450 W FEIN high-power motor: high-power motor with a high copper content, which is suited to continuous use and overload for maximum cutting speed and the most rapid work progress.
- + Tacho generator: constant speeds even under load and infinitely variable electronic speed control.
- + Metal gearbox: ability to withstand high loading and outstanding service life because all the gearbox parts are made from metal.
- + Industrial cable: large working radius thanks to finely stranded 5 metre rubber cable of industrial quality.

MULTIMASTER MM 700 1.7 Q AUTOGLAS



SUPPLIED

3 L-shaped cutter blades, toothed (form 207), 2 L-shaped cutter blades, toothed (form 208), 1 L-shaped cutter blade, toothed (form 209), 1 each U-shaped cutter blade, reinforced design (forms 157 and 111), 2 U-shaped cutter blades, reinforced design, toothed (form 212), 1 Straight cutter blade, Z-bend, with adjustable roller stop (form 143), 1 Straight cutter blade, Z-bend, toothed (form 081), 1 protective cover for tool changes, 1 sharpening stone (6 37 19 010 01 4), 1 plastic carrying case

For accessories, see page 250

Our best oscillating MULTIMASTER for the automotive sector including an extensive set of accessories extensive for cutting out windows and work on the car body.

Input	W	450
Output	W	250
Oscillations	rpm	10,000 - 19,500
Tool Holder		Hexagon
Tool change		QuickIN
Amplitude		2 x 1,7°
Cable with plug	m	5
Weight according to EPTA	kg	1,65

Part number	7 229 70 62 00 0
EAN	4014586893662

FEIN BENEFITS

- + Anti-vibration system: continuously safe and pleasant working thanks to minimal vibrations and outstanding noise insulation.
- + QuickIN: tool changes in less than 3 seconds thanks to the patented tool-free FEIN rapid clamping system.
- + Hexagonal tool holder for optimum torque transfer.
- + 450 W FEIN high-power motor: high-power motor with a high copper content, which is suited to continuous use and overload for maximum cutting speed and the most rapid work progress.
- + Tacho generator: constant speeds even under load and infinitely variable electronic speed control.
- + Metal gearbox: ability to withstand high loading and outstanding service life because all the gearbox parts are made from metal.
- + Industrial cable: large working radius thanks to finely stranded 5 metre rubber cable of industrial quality.

MULTIMASTER MM 700 1.7 Q BUS & TRUCK



SUPPLIED

1 Hook-shaped cutter blade, toothed (form 217), 1 Spade-shaped scraper knife, with scratch-protective coating (form 105), 2 L-shaped cutter blades, toothed (form 207), 2 Straight cutter blades, toothed (form 073), 1 Straight cutter blades, curved shape, Z-bend (form 072), 1 U-shaped cutter blade, toothed (form 212), 2 straight cutter blades, Z-bend, toothed (form 081), 1 L-shaped cutter blade, toothed (form 209), 1 protective cover for tool changes, 1 traction cable with fastening, 1 sharpening stone (6 37 19 010 01 4), 1 plastic carrying case

For accessories, see page 250

Our best oscillating MULTIMASTER including an extensive set of accessories for work on cars and commercial vehicles.

Input	W	450
Output	W	250
Oscillations	rpm	10,000 - 19,500
Tool Holder		Hexagon
Tool change		QuickIN
Amplitude		2 x 1,7°
Cable with plug	m	5
Weight according to EPTA	kg	1,65

Part number	7 229 70 63 00 0
EAN	4014586893709

FEIN BENEFITS

- + Anti-vibration system: continuously safe and pleasant working thanks to minimal vibrations and outstanding noise insulation.
- + QuickIN: tool changes in less than 3 seconds thanks to the patented tool-free FEIN rapid clamping system.
- + Hexagonal tool holder for optimum torque transfer.
- + 450 W FEIN high-power motor: high-power motor with a high copper content, which is suited to continuous use and overload for maximum cutting speed and the most rapid work progress.
- + Tacho generator: constant speeds even under load and infinitely variable electronic speed control.
- + Metal gearbox: ability to withstand high loading and outstanding service life because all the gearbox parts are made from metal.
- + Industrial cable: large working radius thanks to finely stranded 5 metre rubber cable of industrial quality.

MOTLX 6-25



SUPPLIED

2 keys, 1 plastic carrying case

For accessories, see page 250

The powerful pneumatic oscillator for cargo.

Operating pressure	bar	6,3
Air consumption	m ³ /min	0,6
Oscillations	rpm	20,000
Hose size Ø	mm	8
Tool Holder		Hexagon
Tool change		Manual with screw, hexagon socket
Amplitude		2 x 1,6°
Weight according to EPTA	kg	0,9

Part number	7 536 03 00 01 0
EAN	4014586861906

FEIN BENEFITS

- + Available with a comprehensive range of accessories for professional use in many industry sectors.
- + Powerful oscillating motion with amplitude of 2 x 1.6 degrees for maximum work progress.
- + Ideal for removing bonded panes from lorries, buses and rail vehicles.
- + Small size.
- + Supplied with inlet and outlet air hose.
- + No air leaks, no oil misting in working area.
- + Hexagonal tool mounting.

GENERAL ACCESSORIES



PROTECTIVE COVER

For safe tool changes for SuperCut with QuickIN when opening and closing the clamping lever.

Part number
3 21 74 011 00 0



SHARPENING STONE

For sharpening blades before use to produce an optimum cut.

Part number
6 37 19 010 01 4



CUTTING PASTE

Lubricating agents for working on sheet metals.

Part number
3 21 32 020 12 9



WORK GLOVES

Vibration-attenuating, certified according to EN 388/420, EN ISO 10819, EEC No. 0200, No. in pack 1 pair.

Size	Part number
9 L	3 21 73 003 00 3
10 XL	3 21 73 004 00 1
11 XXL	3 21 73 005 00 5



ADAPTER FOR FEIN SUPERCUT WITHOUT QUICKIN

Needed to hold accessories with an 8-star holder (e.g. rasps, sanding and polishing pads).

Part number
3 06 05 114 01 1



ADAPTER FOR FEIN SUPERCUT WITH QUICKIN

Needed to hold accessories with an 8-star holder (e.g. rasps, sanding and polishing pads).

Part number
6 37 33 005 01 0



ADAPTER FOR FEIN SUPERCUT WITH QUICKIN

to mount Starlock accessories on older FEIN SuperCut units with QuickIN tool mounting (FSC 1.6 Q, FSC 1.7 Q, FSC 2.0 Q, AFSC 1.7 Q and AFSC 18). Adapter plus clamping screw.

Part number
3 52 22 952 05 0



ADAPTER FOR FEIN SUPERCUT WITHOUT QUICKIN

to mount Starlock accessories on older FEIN SuperCut units without QuickIN tool mounting (FSC 1.6, FSC 1.7). Adapter plus clamping screw.

Part number
3 52 22 952 04 0

AUTOMOTIVE WORKSHOP ACCESSORIES



STRAIGHT FORM

curved, Z-bend, as subsequent order for removal device 9 06 07 001 01 6, 2-pack.

Part number
6 39 03 197 01 7



SAW BLADES

HSS, with fine teeth for precise cutting. Universal use on sheet metal of up to approx. 1 mm, can be doubled in plastics.

Ø mm	No. in pack pcs	Part number
63	2	6 35 02 102 01 6
63	5	6 35 02 102 07 0
80	2	6 35 02 103 01 0
80	5	6 35 02 103 05 0



E-CUT UNIVERSAL SAW BLADES

Bi-metal teeth, cranked, also suitable for radii, high speed cut, sheet metal (400 N/mm²) up to about 2 mm and plastics, aluminium profiles, copper pipes, wood, plasterboard, and almost all plastics. Length 60 mm, form 147

Width mm	No. in pack pcs	Part number
28	1	6 35 02 147 01 5
28	5	6 35 02 147 02 1



Length 60 mm, form 148

Width mm	No. in pack pcs	Part number
44	1	6 35 02 148 01 3
44	5	6 35 02 148 02 9



STRAIGHT FORM

suitable for round grooves in plastics. toothed, 2-pack.

Total length mm	Cut length mm	Part number
56	35	6 39 03 073 01 1



STRAIGHT FORM

Suitable for removal of chassis attachment parts. Z-bend, toothed, 2-pack.

Total length mm	Cut length mm	Part number
120	60	6 39 03 081 01 3



SCRAPER BLADE

for removing floor covering remains, underseal and residual bonding material, etc., pack of 2

Length mm	No. in pack pcs	Part number
64	2	6 39 03 206 01 8
72	2	6 39 03 227 01 0



CUTTING BLADE

Mushroom-shaped, pack of 5, For cutting elastic silicon or acrylic connecting joints.

Part number
6 39 03 128 01 2

FEIN ACCESSORIES FOR REMOVING RESIDUAL BONDING BEADS



SCRAPER KNIFE

Spade-shaped, with scratch-protective coating, 2-pack.

Total length mm	Cut length mm	Part number
64	12	6 39 03 129 05 0
65	18	6 39 03 146 01 8
64	25	6 39 03 105 01 9



SCRAPER KNIFE

with cross cutter and scratch protective coating on front limit stop, 2-pack.

Cutting width mm	Part number
13	6 39 03 113 01 6
25	6 39 03 131 01 7



SCRAPER KNIFE

with cross cutter, 2-pack.

Cutting width mm	Part number
13	6 39 03 144 01 1



SCRAPER KNIFE SET

consisting of: 1 each of spade-shaped scraper knife, with scratch-protective coating (forms 129/105).

Part number
6 39 03 129 01 6



SCRAPER KNIFE SET

consisting of: 1 each of scraper knife with cross cutter and scratch protective coating on front limit stop (form 113/131).

Part number
6 39 03 113 02 2

VEHICLE GLAZING ACCESSORIES



U-SHAPED

Ideal for removing glass from under the bonnet. short side, 2-pack

Cut length mm	Part number
16	6 39 03 095 01 1
16	6 39 03 108 01 4
18	6 39 03 087 01 9
19,5	6 39 03 118 01 3
22	6 39 03 115 01 8
24	6 39 03 076 01 6
28	6 39 03 163 01 1
32	6 39 03 147 01 2
36	6 39 03 079 01 2
40	6 39 03 110 01 0
60	6 39 03 101 01 0
70	6 39 03 155 01 4



U-SHAPED

Ideal for removing glass from under the bonnet. long side, 2-pack

Cut length mm	Part number
32	6 39 03 114 01 4
32	6 39 03 191 01 1
45	6 39 03 154 01 0
52	6 39 03 153 01 2
60	6 39 03 107 01 6



U-SHAPED

Ideal for removing glass from under the bonnet. reinforced design, 2-pack

Cut length mm	Part number
60	6 39 03 157 01 1
95	6 39 03 111 01 9



U-SHAPED

Ideal for removing glass from under the bonnet. reinforced design, toothed, 2-pack.

Cut length mm	Part number
19	6 39 03 210 01 6
22,5	6 39 03 211 01 5
38	6 39 03 212 01 8



L-SHAPED

toothed, 2-pack.

Cut length mm	Part number
19	6 39 03 208 01 0
25,4	6 39 03 207 01 2
38	6 39 03 209 01 4



STRAIGHT FORM

Pack of 2

Total length mm	Cut length mm	Part number
56	26	6 39 03 121 01 8
90	40	6 39 03 176 01 5
145	35	6 39 03 194 01 6



STRAIGHT FORM

Z-bend, 2-pack.

Total length mm	Cut length mm	Part number
68	19	6 39 03 122 01 1
84	18	6 39 03 181 01 2
65	23	6 39 03 173 01 0
65	25	6 39 03 124 01 3
85	27	6 39 03 174 01 8
110	32	6 39 03 123 01 5
120	70	6 39 03 171 01 3



STRAIGHT FORM
curved, 2-pack

Total length mm	Cut length mm	Part number
65	14	6 39 03 120 01 9
75	16	6 39 03 104 01 5
75	35	6 39 03 103 01 7
75	35	6 39 03 109 01 8
75	35	6 39 03 172 01 6



STRAIGHT FORM
curved, Z-bend, 2-pack

Total length mm	Cut length mm	Part number
120	45	6 39 03 168 01 8
120	70	6 39 03 125 01 7



STRAIGHT FORM
Z-bend, with rigid depth stop, 2-pack.

Total length mm	Cut length mm	Part number
120	16	6 39 03 099 01 0
125	58	6 39 03 097 01 8



STRAIGHT FORM
Z-bend, with adjustable depth stop, 2-pack

Total length mm	Cut length mm	Part number
100	16-43	6 39 03 143 01 3
100	18-39	6 39 03 170 01 4
100	20-35	6 39 03 198 01 5
100	60-76	6 39 03 169 01 2



STRAIGHT FORM
flat, with adjustable depth stop, 2-pack.

Total length mm	Cut length mm	Part number
145	42-60	6 39 03 182 01 5



STRAIGHT FORM
Z-bend, bent with rigid depth stop, 2-pack.

Total length mm	Cut length mm	Part number
120	54	6 39 03 160 01 5



CURVED FORM
Z-bend, with rigid depth stop, 2-pack.

Total length mm	Cut length mm	Part number
80	14	6 39 03 082 01 6
80	16	6 39 03 133 01 4
85	39	6 39 03 152 01 8



CURVED FORM
Z-bend, with adjustable depth stop, 2-pack

Total length mm	Cut length mm	Part number
110	32-46	6 39 03 195 01 0

CARGO ACCESSORIES



L-SHAPED
toothed, 2-pack.

Cut length mm	Part number
25,4	6 39 03 207 01 2
38	6 39 03 209 01 4



STRAIGHT FORM
suitable for round grooves in plastics.
toothed, 2-pack.

Total length mm	Cut length mm	Part number
56	35	6 39 03 073 01 1



STRAIGHT FORM
Suitable for removal of chassis attachment parts.
Z-bend, toothed, 2-pack.

Total length mm	Cut length mm	Part number
120	60	6 39 03 081 01 3



STRAIGHT FORM
Z-bend, 2-pack.

Total length mm	Cut length mm	Part number
120	60	6 39 03 216 01 7



STRAIGHT FORM
Angle cutter, 2-pack.

Total length mm	Cut length mm	Part number
85	65/8	6 39 03 177 01 9
83	35/20	6 39 03 203 01 3



CURVED FORM
Z-bend, 2-pack.

Total length mm	Cut length mm	Part number
80	45	6 39 03 072 01 7



U-SHAPED
with elongated traverse, 2-pack.

Cut length mm	Part number
40	6 39 03 156 01 7



HOOK-SHAPED
toothed, 2-pack.

Cut length mm	Part number
38	6 39 03 217 01 1

**SEGMENT BLADE**

Segment form for V-cut from outside and for cuts in corners, 2-pack

Total length mm	Cut length mm	Part number
73	30	6 39 03 132 01 0

**WORK GLOVES**

Vibration-attenuating, certified according to EN 388/420, EN ISO 10819, EEC No. 0200, No. in pack 1 pair.

Size	Part number
9 L	3 21 73 003 00 3
10 XL	3 21 73 004 00 1
11 XXL	3 21 73 005 00 5

**BAIL HANDLE**

To reduce the vibrations and for better handling of the FEIN SuperCut during longer jobs. Can be used in connection with the dust extraction device 9 26 02 084 01 0.

Part number
3 21 19 116 01 1

ACCESSORY SETS**AUTOMOBILE GLAZIER ACCESSORY SET**

Consisting of: 3 L-shaped cutter blades, toothed (form 207), 2 L-shaped cutter blades, toothed (form 208), 1 L-shaped cutter blade, toothed (form 209), 1 each of U-shaped cutter blade, reinforced version (form 157 and 111), 2 U-shaped cutter blades, reinforced version, toothed (form 212), 1 straight cutter blade, Z-bend with adjustable stop roller (form 143), 1 straight cutter blade, Z-bend, toothed (form 081).

Part number
6 39 03 167 38 3

**AUTOMOBILE WORKSHOP ACCESSORIES SET**

Consisting of: 2 U-shaped cutter blades, short side (form 076), 2 U-shaped cutter blades, short side (1x form 079 and 1x form 101), 2 L-shaped cutter blades, toothed (form 207), 1 L-shaped cutter blade, toothed (form 208), 1 U-shaped cutter blade, reinforced (form 157), 1 straight cutter blade, Z-bend, with adjustable stop roller (form 143), 1 shovel-shaped scraper blade, with scrape protection coating (form 129), 1 stopper knife, 1 HSS saw blade (Ø 80 mm).

Part number
6 39 03 167 25 7

**ACCESSORY SET FOR CARGO**

Subsequent order to Professional set Cargo consisting of: 2 straight cutter blades, toothed (form 073), 1 straight cutter blade, Z-bend, toothed (form 081), 1 hook-shaped cutter blade, toothed (form 217), 1 curved cutter blade, Z-bend, (form 072), 1 each of L-shaped cutter blade, toothed (forms 207 and 209), 1 spade-shaped scraper knife, with scratch-protective coating (form 105), 1 traction cable, 1 depth stop

Part number
6 39 03 167 32 0

18 V BATTERY**QUICK CHARGER ALG 80 BC**

Bluetooth® connectivity for connecting to a mobile end device and for use with the my.FEIN app. Shows the current charge state and the number of charge cycles to date on your smartphone or tablet. Provides notification when the battery is fully charged. Short charge times thanks to high charge current of 8 amps and process-controlled charge management. Large LED display with charge indicator and USB port for mobile charging of small electrical devices. For all FEIN Li-ion batteries. Charge times (80 % of max. capacity): 12 and 18 V / 3 Ah: 31 min., 12 and 18 V / 6 Ah: 38 min., 18 V / 5.2 Ah: 33 min.

Part number
9 26 04 210 01 0

**BATTERY PACK**

Li-ion battery with charge status indicator and FEIN SafetyCell technology. Protects the battery and tool from overload, overheating and total discharge. Can be used with all FEIN 18 V cordless tools.

Current/Voltages V	Capacity Ah	Weight kg	Part number
18	6	0,7	9 26 04 175 02 0
18	3	0,45	9 26 04 182 02 0

**BATTERY STARTER SET**

2 x Li-ion batteries with ALG 80 BC rapid charger. Bluetooth® connectivity for connecting to a mobile end device and for use with the my.FEIN app. Shows the current charge state and the number of charge cycles to date on your smartphone or tablet. Provides notification when the battery is fully charged. Short charge times thanks to high charge current of 8 amps and process-controlled charge management. Large LED display with charge indicator and USB port for mobile charging of small electrical devices. For all FEIN Li-ion batteries. Charge times (80 % of max. capacity): 12 and 18 V / 3 Ah: 31 min., 12 and 18 V / 6 Ah: 38 min., 18 V / 5.2 Ah: 33 min.

Current/Voltages V	Capacity Ah	Part number
18	6	9 26 04 323 01 0
18	3	9 26 04 324 01 0



BELT GRINDERS

GRIT GHB HAND-GUIDED BELT GRINDER 256

The belt grinding system for various applications, can be used for mobile and stationary jobs.

GRIT GX BASIC BELT GRINDER 259
FOR MANUAL TRADES

Stationary belt grinders for use in trade and small-scale volume production.

GRIT GX ADD-ON MODULES 261
FOR MANUAL TRADES

GRIT GI BASIC BELT GRINDER 262
FOR INDUSTRY

Stationary belt grinders for use in industry and volume production.

GRIT GI ADD-ON MODULES 265
FOR INDUSTRY

GRIT GKS COMPACT BELT GRINDER 270

The space-saving and economical solution for the workshop.

GRIT GHB 15-50

Powerful handheld belt grinder for flexible on-site use.

**SUPPLIED**

1 grinding belt 50 x 1,000 mm (K 36)

For accessories, see page 258

Input	kW	1,5
Current/Voltages		1 x 230 V
Speed, no load	rpm	8,500
Belt size	mm	50 x 1,000
Cable with plug	m	4
Weight according to EPTA	kg	6

Part number	7 245 01 60 00 0
EAN	4014586894331

FEIN BENEFITS

- + Hand-guided alternative for angle grinders.
- + Stationary use possible with table holder.
- + Patented tool-free belt clamping system.
- + anti-vibration handle.
- + Very short tooling time for stationary belt grinding.
- + Height-adjustable table for flat grinding.

GRIT GHB 15-50 INOX

Universal handheld belt grinder for on-site problem-solving, ideal for stainless steel processing.

**SUPPLIED**

1 grinding belt 50 x 1,000 mm (K 36)

For accessories, see page 258

Input	kW	1,5
Current/Voltages		1 x 230 V
Speed, no load	rpm	2,500 - 7,900
Belt size	mm	50 x 1,000
Cable with plug	m	4
Weight according to EPTA	kg	6

Part number	7 245 02 60 00 0
EAN	4014586894362

FEIN BENEFITS

- + Hand-guided alternative for angle grinders for trades and industry.
- + Stationary use possible with table holder.
- + Patented tool-free belt clamping system.
- + anti-vibration handle.
- + Very short tooling time for stationary belt grinding.
- + Height-adjustable table for flat grinding.

GRIT GHBD

Module for stationary belt grinding.

**SUPPLIED**

1 GHBD module

For accessories, see page 258

Dimensions LxWxH	mm	560 x 240 x 230
Belt size	mm	50 x 1,000
Weight	kg	5,8

Part number	9 90 01 012 00 0
EAN	4014586880488

FEIN BENEFITS

- + Transforms hand-guided GHB into a stationary belt grinder.
- + Perfect chamfering thanks to adjustable grinding table.
- + Process profiles & pipes on the grinding table.
- + Designed for heavy-duty use.

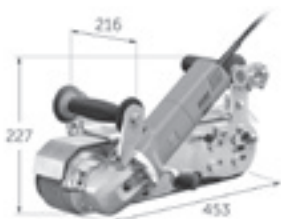

GHB 15-50
GHB 15-50 INOX

GRIT GHBR

Module for stationary pipe notching.

Pipes up to Ø	mm	16 - 42.4
Dimensions LxWxH	mm	700 x 240 x 207
Belt size	mm	50 x 1,150
Weight	kg	13

Part number	9 90 01 012 02 0
EAN	4014586887005

FEIN BENEFITS

- + Can also be used on site.
- + Easily process pipes with different diameters.
- + Exact radii in one work step.
- + For accurately grinding out radii (with a diameter of 16 to 42,40 mm) on pipes and profiles.
- + Contact rollers for different pipe diameters.
- + Use only with GHB15-50 INOX.

SUPPLIED

Supplied without contact roller or grinding belt

For accessories, see page 258**GRIT GHBM**

Module for mobile surface processing.

Dimensions LxWxH	mm	430 x 252 x 166
Belt size	mm	50 x 1,000
Weight	kg	5

Part number	9 90 01 012 01 0
EAN	4014586886992

FEIN BENEFITS

- + Minimal effort required when grinding long welded seams thanks to roller guide.
- + Convert to a different application in under 45 seconds.
- + Homogeneous surfaces in one work step.
- + Low-fatigue machining of large areas.

For accessories, see page 258**GRIT GHBML**

Module with guide rod for mobile surface processing.

Dimensions LxWxH	mm	870 x 400 x 920
Belt size	mm	50 x 1,000
Weight	kg	10,8

Part number	9 90 01 012 03 0
EAN	4014586887548

FEIN BENEFITS

- + Comfortable and ergonomic. Adjustable guide rod enables upright working.
- + Minimal effort required when grinding long welded seams thanks to roller guide.
- + Innovative, optical guide for straight sanding lines. With lateral continuous adjustment. Laser pointers can be fastened.
- + Dead man's switch.
- + Perfect and homogeneous surface in one work step. Better than any angle grinder.
- + Clean work areas thanks to removable dust collecting vessel.
- + Module can be used with GHB 15-50 and GHB 15-50 Inox, depending on sanding tasks in hand.

SUPPLIED

1 dust collecting vessel,
 1 anti-vibration handle,
 1 guide with lateral continuous adjustment

For accessories, see page 258

GRINDING BELTS



3M™ CUBITRON™ II
Precision grinding belt with ceramic grain guarantees maximum performance and service life. The evenly shaped ceramic grains produce a uniquely accurate feel during machining. The result is cool grinding without tarnishing and better surface quality.
50 x 1,000 mm

Grain	No. in pack pcs	Part number
36	10	6 99 03 126 00 0
60	10	6 99 03 127 00 0
80	10	6 99 03 128 00 0



3M™ CUBITRON™ II
Precision grinding belt with ceramic grain guarantees maximum performance and service life. The evenly shaped ceramic grains produce a uniquely accurate feel during machining. The result is cool grinding without tarnishing and better surface quality.
50 x 1150 mm, for pipe notching with GRIT GHBR module.

Grain	No. in pack pcs	Part number
36	10	6 99 03 157 00 0



GRINDING MATERIAL Z
It's the all-rounder for grinding and deburring steel and non-ferrous metals which also satisfies the most stringent requirements. Developed in collaboration with professional users, this grinding material features an impressively long service life and high performance and is cost-effective to use. Heavy polyester fabric, fully bonded with artificial resins, with zirconium corundum.
50 x 1,000 mm

Grain	No. in pack pcs	Part number
36	10	6 99 03 130 00 0
60	10	6 99 03 131 00 0
80	10	6 99 03 132 00 0
120	10	6 99 03 133 00 0



GRINDING MATERIAL Z
It's the all-rounder for grinding and deburring steel and non-ferrous metals which also satisfies the most stringent requirements. Developed in collaboration with professional users, this grinding material features an impressively long service life and high performance and is cost-effective to use. Heavy polyester fabric, fully bonded with artificial resins, with zirconium corundum.
50 x 1150 mm, for pipe notching with GRIT GHBR module.

Grain	No. in pack pcs	Part number
36	10	6 99 03 159 00 0



GRINDING MATERIAL A
Grinding belts with fine grit for fine grinding of metals to final finish. For the best surface results. Heavy cotton fabric, fully bonded with artificial resins, with corundum.
50 x 1,000 mm

Grain	No. in pack pcs	Part number
220	10	6 99 03 134 00 0
320	10	6 99 03 135 00 0
420	10	6 99 03 136 00 0



GRINDING MATERIAL R
It's the top grinding belt on the market, featuring superior service life and performance for considerably shorter working times. Especially recommended for machining stainless and high-alloy steel. Extra heavy polyester fabric, fully bonded with artificial resins, with zirconium corundum. Additional top layer for cooling during grinding.
50 x 1,000 mm

Grain	No. in pack pcs	Part number
36	10	6 99 03 137 00 0
60	10	6 99 03 138 00 0
80	10	6 99 03 139 00 0
120	10	6 99 03 140 00 0

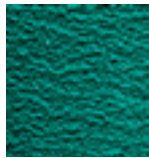

GRINDING MATERIAL R
It's the top grinding belt on the market, featuring superior service life and performance for considerably shorter working times. Especially recommended for machining stainless and high-alloy steel. Extra heavy polyester fabric, fully bonded with artificial resins, with zirconium corundum. Additional top layer for cooling during grinding.
50 x 1150 mm, for pipe notching with GRIT GHBR module.

Grain	No. in pack pcs	Part number
36	10	6 99 03 158 00 0

FLEECE STRIPS

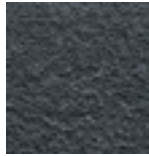

FLEECE BELT
Reliable for everything from covering up minor mistakes to a perfect finish. Long service lives make for cost-effective working.
50 x 1,000 mm

Model	No. in pack pcs	Part number
medium	3	6 99 03 143 00 0

ACCESSORIES FOR GHBR



CONTACT ROLLER
Long service lives, low roll resistance thanks to high-quality ball bearings, easy to interchange

Ø mm	Width mm	Part number
16	50	6 99 02 000 40 9
18	50	6 99 02 000 41 0
19	50	6 99 02 000 41 1
20	50	6 99 02 000 41 2
21	50	6 99 02 000 41 3
21,3	50	6 99 02 000 41 4
22	50	6 99 02 000 41 5
25	50	6 99 02 000 41 6
25,4	50	6 99 02 000 41 7
26	50	6 99 02 000 41 8
26,9	50	6 99 02 000 41 9
27	50	6 99 02 000 42 0
28	50	6 99 02 000 42 1
28,8	50	6 99 02 000 42 2
30	50	6 99 02 000 42 3
31,7	50	6 99 02 000 42 4
33	50	6 99 02 000 42 6
33,7	50	6 99 02 000 42 7
34	50	6 99 02 000 42 8
35	50	6 99 02 000 42 9
38	50	6 99 02 000 43 0
38,1	50	6 99 02 000 43 1
38,3	50	6 99 02 000 43 2
40	50	6 99 02 000 43 3
42	50	6 99 02 000 43 4
42,4	50	6 99 02 000 43 5

OTHER ACCESSORIES FOR GRIT GHB

STAINLESS STEEL SANDING SUPPORT
GRIT GHB 15-50 Inox

Part number
3 90 00 008 10 6

GRIT GX basic belt grinder for manual trades

GRIT GX is based on the modular principle. In other words, you start with a high-value belt grinder – and additional modules can be added if necessary to extend the range of performance. This saves times, money and space.

This flexible design makes the GX range ideally suited to frequent use in manual trades. The GRIT GX range also provides impressive levels of maximum performance, reliability and excellent cost-effectiveness.

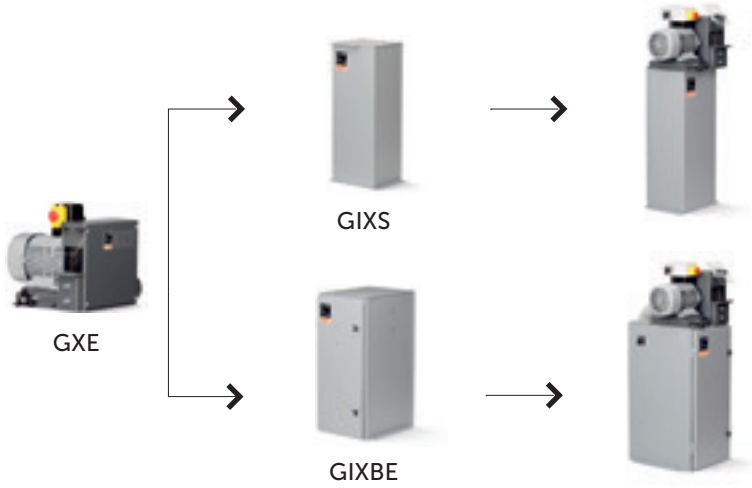
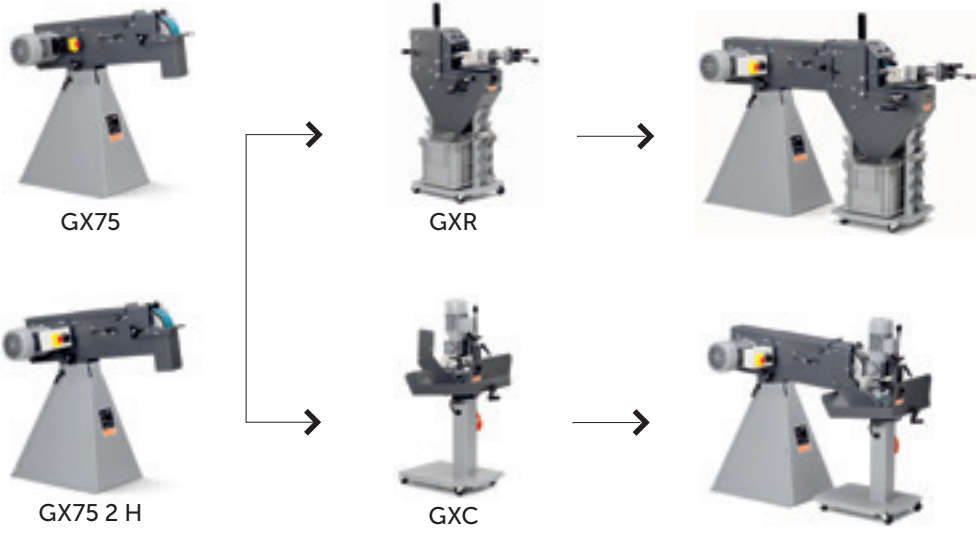

GRIT GX 75

Powerful belt grinder, modular expandable, for manual trades and for small series.

Input	kW	3
Current/Voltages		3 x 400/440 V 50/60 Hz
Speed, no load	rpm	3,000
Belt size	mm	75 x 2,000
Weight	kg	75

Part number	7 901 31 00 40 3
EAN	4014586872018

FEIN BENEFITS

- + Expandable because of additional modules.
- + Speeds optimal for metal working at 3 000 rpm.
- + Height-adjustable plane grinding table for linear plane grinding.
- + Detachable swarf collector.
- + Connection for extraction option available.
- + Work level is individually adjustable.
- + Patented belt-tensioning system.
- + Robust three-phase AC motor.
- + Low vibrations.

SUPPLIED

1 CEE plug (16 A), 1 grinding belt
75 x 2 000 mm (K 36 R)

For accessories, see page 273

GRIT GX 75 2H

Powerful belt grinder, modular expandable, for manual trades and for small series, ideal for machining stainless steel

Input	kW	1.5 / 2
Current/Voltages		3 x 400/440 V 50/60 Hz
Speed, no load	rpm	1,500 / 3,000
Belt size	mm	75 x 2,000
Weight	kg	75

Part number	7 901 32 00 40 3
EAN	4014586872063

FEIN BENEFITS

- + Expandable because of additional modules.
- + Speeds optimal for metal and stainless steel working at 1-500/3 000 rpm.
- + Height-adjustable plane grinding table for linear plane grinding.
- + Detachable swarf collector.
- + Connection for extraction option available.
- + Work level is individually adjustable.
- + Patented belt-tensioning system.
- + Robust three-phase AC motor.
- + Low vibrations.

SUPPLIED

1 grinding belt 75 x 2 000 mm
(K 36 R), 1 CEE plug (16 A)

For accessories, see page 273

GRIT GXE**SUPPLIED**

1 CEE plug (16 A),
Supplied without steel brush

For accessories, see page 273

Highly effective deburring machine for manual trades and for small series.

Input	kW	2,2
Current/Voltages		3 x 400/440 V 50/60 Hz
Speed, no load	rpm	1,500
Tool dimensions max. Ø x width	mm	250 x 60
Weight	kg	32

Part number	7 901 05 00 40 3
EAN	4014586857879

FEIN BENEFITS

- + Modular extendable with sturdy machine base also with integrated extraction.
- + Robust AC motor provides deburring with steady speed.
- + For deburring of metal pipes, profiles, and flat materials up to a workpiece width of 75 mm.
- + Connection for extraction option available.
- + Broad range of wire brushes available.
- + Effective deburring.
- + Motor protection switch.

GRIT GXC**SUPPLIED**

1 guide rail, nylon, 1 guide rail, brass,
1 CEE plug (16 A)

For accessories, see page 273

Cylindrical grinding module for perfect surfaces of metal and stainless steel pipes and shafts.

Input	kW	0,18
Current/Voltages		3 x 400/440 V 50/60 Hz
Pipes up to Ø	mm	10 - 100
Belt size	mm	75 x 2,000
Weight	kg	48

Part number	7 901 23 00 44 3
EAN	4014586871936

FEIN BENEFITS

- + Automatic feed is individually adjustable.
- + High process speed at highest surface quality.
- + For grinding of pipes and shafts of diameters ranging from Ø 10 - 100 mm.
- + Combination possibilities with belt grinders GX 75 (2H).
- + Wet grinding in possible combination with GXW.

GRIT GXW**SUPPLIED**

1 litre cooling lubricant emulsion
(1:30)

For accessories, see page 273

Cooling lubricant module for a professional wet grinding.

Input	kW	0,12
Current/Voltages		3 x 400/440 V 50/60 Hz
Weight	kg	8,6

Part number	7 901 24 00 44 3
EAN	4014586873145

FEIN BENEFITS

- + Perfect surface results due to effective cooling lubricant supply
- + Reduces the temperature of the workpiece.
- + Binds the swarf.
- + Closed circuit.
- + Combination possibilities with belt grinders GX 75 (2H) and GI 75 (2H).
- + Increases service life of the grinding belts.

GRIT GXR**SUPPLIED**

1 contact roller Ø 42,4 mm,
1 contact roller Ø 48,3 mm,
1 grinding belt 75 x 2 250 (K 36 R)

For accessories, see page 273

Radii-grinding module for precision fitting of pipes, profiles, and flat materials.

Pipes up to Ø	mm	16 - 75
Belt size	mm	75 x 2,250
Dimension profiles / flat material max.	mm	75 x 75
Weight	kg	54

Part number	9 90 01 001 00 1
EAN	4014586871974

FEIN BENEFITS

- + For accurately grinding out radii (with a diameter of 16 to 90 mm) on pipes and profiles.
- + Contact rollers are optionally available in standard dimensions.
- + Optional length stop for series application.
- + Integrated depth stop.
- + Combination possibilities with belt grinders GX 75 (2H).
- + Angle setting, individually possible up to 90°.

GRIT GI basic belt grinder for industry

The GRIT GI range is perfectly coordinated to all grinding applications, materials and formats in the metal industry. Thanks to the modular system, you can assemble the machine to suit your requirements – even for steps that have already been partly automated. The high quality,

robustness and outstanding power of the tools guarantee maximum efficiency and mean that the tools pay for themselves quickly, as they offer complete reliability, even in continuous use.

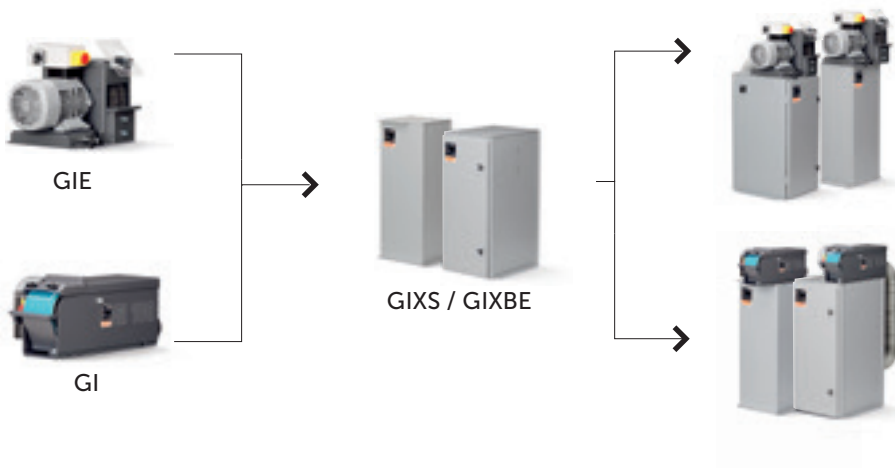
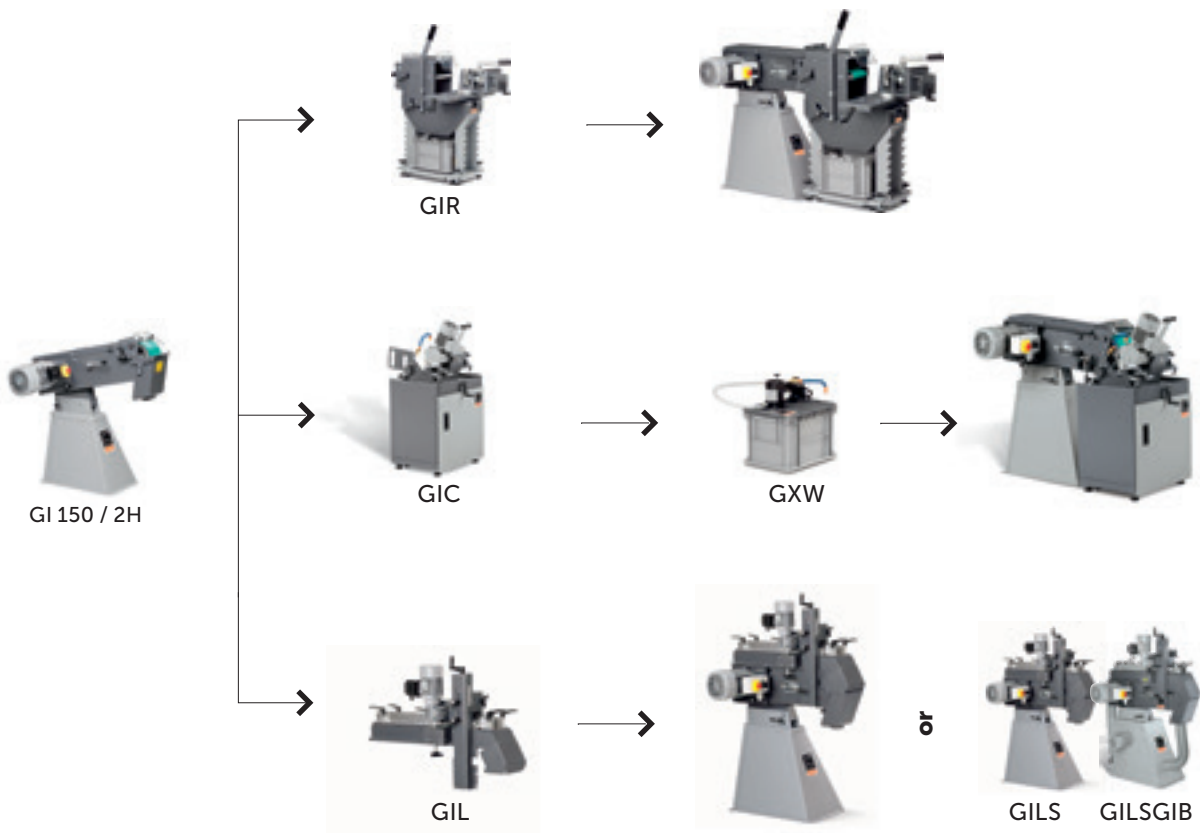
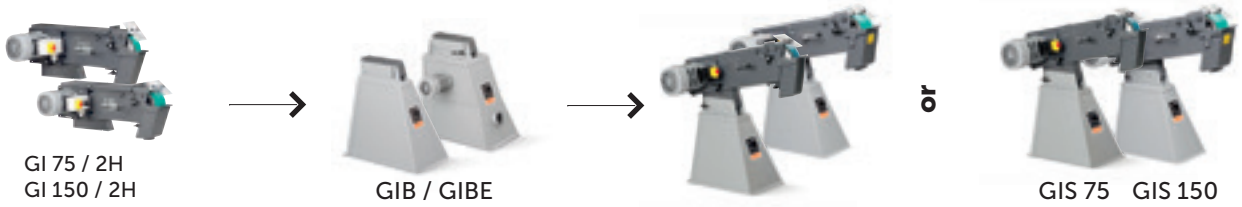

GRIT GI 75

High-performance belt grinder, modular expandable, for industrial and series applications.

Input	kW	4
Current/Voltages		3 x 400/440 V 50/60 Hz
Speed, no load	rpm	3,000
Belt size	mm	75 x 2,000
Weight	kg	65

FEIN BENEFITS

- + Quite robust AC motor provides grinding with steady speed.
- + Speeds optimal for metal working at 3 000 rpm.
- + Detachable swarf collector.
- + Connection for extraction option available.
- + Drive disk with polyurethane coating
- + Work level is individually adjustable.
- + Patented belt-tensioning system.
- + Robust three-phase AC motor.
- + Low vibrations.

SUPPLIED

1 CEE plug (16 A), 1 grinding belt 75 x 2 000 mm (K 36 R)

For accessories, see page 273

Part number	7 902 01 00 40 3
EAN	4014586858913

GRIT GI 75 2H

High-performance belt grinder, modular expandable, for industrial and series applications, ideal for machining stainless steel.

Input	kW	2.6 / 3.1
Current/Voltages		3 x 400/440 V 50/60 Hz
Speed, no load	rpm	1,500 / 3,000
Belt size	mm	75 x 2,000
Weight	kg	65

FEIN BENEFITS

- + Quite robust AC motor provides grinding with steady speed.
- + Speeds optimal for metal and stainless steel working at 1-500/3 000 rpm.
- + Detachable swarf collector.
- + Connection for extraction option available.
- + Drive disk with polyurethane coating
- + Work level is individually adjustable.
- + Exceedingly robust three-phase AC motor
- + Patented belt-tensioning system.
- + Low vibrations.

SUPPLIED

1 CEE plug (16 A), 1 grinding belt 75 x 2 000 mm (K 36 R)

For accessories, see page 273

Part number	7 902 02 00 40 3
EAN	4014586858944

GRIT GI 100 EF

Powerful belt grinder in small format: for universal application on small workpieces

Input	kW	1,1
Current/Voltages		1 x 230 V
Speed, no load	rpm	3,000
Belt size	mm	100 x 1,000
Weight	kg	29,8

FEIN BENEFITS

- + Universally applicable belt grinder for smaller workpieces
- + Modular extendable with sturdy machine base also with integrated extraction.
- + Can be used as a table machine
- + Single-phase, alternating current version 230 V / 50 Hz
- + Suited also for mobile employment in workshop or assembly vehicles
- + Patented belt-tensioning system.

SUPPLIED

1 grinding belt 100 x 1 000 (K 60 Z)

For accessories, see page 273

Part number	7 902 23 00 23 2
EAN	4014586887043

GRIT GI 100

Powerful belt grinder in small format: for universal application on small workpieces

Input	kW	1,5
Current/Voltages		3 x 400/440 V 50/60 Hz
Speed, no load	rpm	3,000
Belt size	mm	100 x 1,000
Weight	kg	28,8

FEIN BENEFITS

- + Universally applicable belt grinder for smaller workpieces
- + Modular extendable with sturdy machine base also with integrated extraction.
- + Can be used as a table machine
- + Three-phase AC motor 1 500 W.
- + Suited also for mobile employment in workshop or assembly vehicles
- + Patented belt-tensioning system.

SUPPLIED

1 grinding belt 100 x 1 000 (K 60 Z)

For accessories, see page 273

Part number	7 902 23 00 40 3
EAN	4014586887067

GRIT GI 150**SUPPLIED**

1 CEE plug (16 A), 1 grinding belt
150 x 2,000 mm (K 36 R)

For accessories, see page 273

High-performance belt grinder, modular expandable, for industrial and series applications.

Input	kW	4
Current/Voltages		3 x 400/440 V 50/60 Hz
Speed, no load	rpm	3,000
Belt size	mm	150 x 2,000
Weight	kg	82

Part number	7 902 04 00 40 3
EAN	4014586858999

FEIN BENEFITS

- + Expandable because of additional modules.
- + Quite robust AC motor provides grinding with steady speed.
- + Speeds optimal for metal working at 3 000 rpm.
- + Detachable swarf collector.
- + Connection for extraction option available.
- + Drive disk with polyurethane coating
- + Work level is individually adjustable.
- + Patented belt-tensioning system.
- + Robust three-phase AC motor.
- + Low vibrations.

GRIT GI 150 2H**SUPPLIED**

1 CEE plug (16 A), 1 grinding belt
150 x 2,000 mm (K 36 R)

For accessories, see page 273

High-performance belt grinder, modular expandable, for industrial and series applications, ideal for machining stainless steel.

Input	kW	2,6 / 3,1
Current/Voltages		3 x 400/440 V 50/60 Hz
Speed, no load	rpm	1,500 / 3,000
Belt size	mm	150 x 2,000
Weight	kg	82

Part number	7 902 05 00 40 3
EAN	4014586859019

FEIN BENEFITS

- + Expandable because of additional modules.
- + Quite robust AC motor provides grinding with steady speed.
- + Speeds optimal for metal and stainless steel working at 1-500/3 000 rpm.
- + Detachable swarf collector.
- + Connection for extraction option available.
- + Drive disk with polyurethane coating
- + Work level is individually adjustable.
- + Patented belt-tensioning system.
- + Low vibrations.

GRIT GIS 75**SUPPLIED**

1 CEE plug (16 A), 1 grinding belt
75 x 2 000 mm (K 36 R)

For accessories, see page 273

High-performance grinder for standard grinding tasks.

Input	kW	4
Current/Voltages		3 x 400/440 V 50/60 Hz
Speed, no load	rpm	3,000
Idle speed at 50 Hz	rpm	3,000
Idle speed at 60 Hz	rpm	3,450
Belt size	mm	75 x 2,000
Weight	kg	74

Part number	7 902 29 50 44 3
EAN	4014586878126

FEIN BENEFITS

- + High-performance belt grinder with sturdy machine base
- + Constant speed at high grinding performance thanks to robust 4-kW motor
- + Very good price-performance ratio
- + Detachable swarf collector.
- + Patented belt-tensioning system.
- + Low-vibration thanks to robust design

GRIT GIS 150**SUPPLIED**

1 CEE plug (16 A), 1 grinding belt
150 x 2,000 mm (K 36 R)

For accessories, see page 273

High-performance grinder for standard grinding applications for extra-wide workpieces.

Input	kW	4
Current/Voltages		3 x 400/440 V 50/60 Hz
Speed, no load	rpm	3,000
Idle speed at 50 Hz	rpm	3,000
Idle speed at 60 Hz	rpm	3,450
Belt size	mm	150 x 2,000
Weight	kg	93

Part number	7 902 30 50 44 3
EAN	4014586878225

FEIN BENEFITS

- + High-performance belt grinder with sturdy machine base
- + Constant speed at high grinding performance thanks to robust 4-kW motor
- + Very good price-performance ratio
- + Detachable swarf collector.
- + Patented belt-tensioning system.
- + Low-vibration thanks to robust design

GRIT GIE

Highly effective deburring machine for industrial deburring in series.

Input	kW	1.5 / 2.0
Current/Voltages		3 x 400/440 V 50/60 Hz
Speed, no load	rpm	1,500 / 3,000
Tool dimensions max. Ø x width	mm	250 x 60/120
Weight	kg	34

Part number	7 902 07 00 40 3
EAN	4014586859057

FEIN BENEFITS

- + Speeds optimal for metal and stainless steel working at 1-500/3 000 rpm.
- + Modular extendable with sturdy machine base also with integrated extraction.
- + Robust AC motor provides deburring with steady speed.
- + Connection for extraction option available.
- + Broad range of wire brushes available.
- + Effective deburring.
- + Motor protection switch.

SUPPLIED

1 CEE plug (16 A),
Supplied without steel brush

For accessories, see page 273**GRIT GIC**

Centreless grinding module for industrial centreless grinding in volume production

Input	kW	0,18
Current/Voltages		3 x 400/440 V 50/60 Hz
Pipes up to Ø	mm	10 - 130
Belt size	mm	75/150 x 2,000
Variable Feed	m/min	0 - 2
Weight	kg	65

Part number	7 902 12 00 44 3
EAN	4014586867656

FEIN BENEFITS

- + For industrial centreless grinding of pipes up to 6 m long with optional pipe guide.
- + Flexible when machining pipe diameters of between 10 and 130 mm.
- + Cool surfaces and a long grinding belt service life thanks to wet grinding in conjunction with the cooling lubricant module GXW.
- + Combination possibility with belt grinder Gi 150 (2H)
- + Quick fastener for simple retooling without the need for tools.
- + Infinitely variable feed speed from 0 to 2 m/min.

SUPPLIED

1 guide rail, nylon, 1 guide rail, brass,
1 CEE plug (16 A)

For accessories, see page 273**GRIT GIMS 75**

Mobile carriage for effective grinding "on site" at the floor.

Input	kW	4
Current/Voltages		3 x 400/440 V 50/60 Hz
Speed, no load	rpm	3,000
Belt size	mm	75 x 2,000
Weight	kg	100

Part number	7 902 13 00 40 3
EAN	4014586872599

FEIN BENEFITS

- + Comfortable work handling thanks to standing work position
- + Highly effective grinding and polishing of weld seams on the floor
- + Grinding over and descaling of steel parts
- + Towing bar position can be adjusted infinitely variable
- + Minimum wall clearance
- + Depth stop

For accessories, see page 273**GRIT GIMS 150**

Mobile carriage for effective grinding "on site" at the floor.

Input	kW	4
Current/Voltages		3 x 400/440 V 50/60 Hz
Speed, no load	rpm	3,000
Belt size	mm	150 x 2,000
Weight	kg	110

Part number	7 902 14 00 40 3
EAN	4014586872643

FEIN BENEFITS

- + Comfortable work handling thanks to standing work position
- + Highly effective grinding and polishing of weld seams on the floor
- + Grinding over and descaling of steel parts
- + Towing bar position can be adjusted infinitely variable
- + Minimum wall clearance
- + Depth stop

For accessories, see page 273

GIMS 75 2H

Mobile carriage for effective grinding "on site" at the floor.



For accessories, see page 273

Input	kW	2.6 / 3.1
Current/Voltages		3 x 400/440 V 50/60 Hz
Speed, no load	rpm	1,500 / 3,000
Belt size	mm	75 x 2,000
Weight	kg	103

Part number	7 902 16 00 40 3
EAN	4014586878614

FEIN BENEFITS

- + Comfortable work handling thanks to standing work position
- + Highly effective grinding and polishing of weld seams on the floor
- + Grinding over and descaling of steel parts
- + Speeds optimal for metal and stainless steel working at 1-500/3 000 rpm.
- + Towing bar position can be adjusted infinitely variable
- + Minimum wall clearance
- + Depth stop

GIMS 150 2H

Mobile carriage for effective grinding "on site" at the floor.



For accessories, see page 273

Input	kW	2.6 / 3.1
Current/Voltages		3 x 400/440 V 50/60 Hz
Speed, no load	rpm	1,500 / 3,000
Belt size	mm	150 x 2,000
Weight	kg	114

Part number	7 902 17 00 40 3
EAN	4014586878621

FEIN BENEFITS

- + Comfortable work handling thanks to standing work position
- + Highly effective grinding and polishing of weld seams on the floor
- + Grinding over and descaling of steel parts
- + Speeds optimal for metal and stainless steel working at 1-500/3 000 rpm.
- + Towing bar position can be adjusted infinitely variable
- + Minimum wall clearance
- + Depth stop

GIMS 75-6

Mobile carriage for effective grinding "on site" at the floor.



For accessories, see page 273

Input	kW	6
Current/Voltages		3 x 400/440 V 50/60 Hz
Speed, no load	rpm	3,000
Belt size	mm	75 x 2,000
Weight	kg	121

Part number	7 902 18 00 40 3
EAN	4014586878645

FEIN BENEFITS

- + Highly effective grinding and polishing of weld seams on the floor
- + Grinding over and descaling of steel parts
- + Comfortable work handling thanks to standing work position
- + Minimum wall clearance
- + Towing bar position can be adjusted infinitely variable
- + Depth stop

GIMS 150-6

Mobile carriage for effective grinding "on site" at the floor.



For accessories, see page 273

Input	kW	6
Current/Voltages		3 x 400/440 V 50/60 Hz
Speed, no load	rpm	3,000
Belt size	mm	150 x 2,000
Weight	kg	131

Part number	7 902 19 00 40 3
EAN	4014586878683

FEIN BENEFITS

- + Highly effective grinding and polishing of weld seams on the floor
- + Grinding over and descaling of steel parts
- + Comfortable work handling thanks to standing work position
- + Minimum wall clearance
- + Towing bar position can be adjusted infinitely variable
- + Depth stop

GRIT GILSGIB**SUPPLIED**

1 CEE plug (16 A), 1 grinding belt
150 x 2,000 mm (K 120 R)

For accessories, see page 273

Surface grinder for perfect longitudinal grinding of square pipes, profiles and flat materials in automatic processes.

Input	kW	2.6 / 3.1
Current/Voltages		3 x 400/440 V 50/60 Hz
Speed, no load	rpm	1,500 / 3,000
Belt size	mm	150 x 2,000
Dimension profiles / flat material max.	mm	100 x 100
Weight	kg	189

Part number	7 902 35 00 40 3
EAN	4014586880921

without dust extraction

FEIN BENEFITS

- + High operating speed because of automatic feed
- + Perfect finishing results up to the finish
- + Flat material can also be ground "upright".
- + Consistent belt dimensions 150 x 2 000 mm.
- + Belt grinder can be used for contact grinding even though module is mounted.
- + For angled workpieces
- + Space-saving employment because of optional swivel plate possible.

GRIT GIL

For accessories, see page 273

Plane grinding module for perfect longitudinal grinding of square pipes, profiles and flat materials.

Input	kW	0,18
Current/Voltages		3 x 400/440 V 50/60 Hz
Belt size	mm	150 x 2,000
Dimension profiles / flat material max.	mm	100 x 100
Weight	kg	64

Part number	7 902 48 00 40 3
EAN	4014586880945

FEIN BENEFITS

- + High operating speed because of automatic feed
- + Perfect finishing results up to the finish
- + Flat material can also be ground "upright".
- + Consistent belt dimensions 150 x 2 000 mm.
- + Belt grinder can be used for contact grinding even though module is mounted.
- + For angled workpieces
- + Combination possibility with belt grinder GI 150 (2H)
- + Space-saving employment because of optional swivel plate possible.

GRIT GILS**SUPPLIED**

1 grinding belt 150 x 2,000 mm
(K 120 R), 1 CEE plug (16 A)

For accessories, see page 273

Surface grinder for perfect longitudinal grinding of square pipes, profiles and flat materials in automatic processes.

Input	kW	2.6 / 3.1
Current/Voltages		3 x 400/440 V 50/60 Hz
Speed, no load	rpm	1,500 / 3,000
Belt size	mm	150 x 2,000
Dimension profiles / flat material max.	mm	100 x 100
Weight	kg	206

Part number	7 902 51 00 40 3
EAN	4014586880976

with dust extraction

FEIN BENEFITS

- + High operating speed because of automatic feed
- + Perfect finishing results up to the finish
- + Flat material can also be ground "upright".
- + Consistent belt dimensions 150 x 2 000 mm.
- + Belt grinder can be used for contact grinding even though module is mounted.
- + For angled workpieces
- + Space-saving employment because of optional swivel plate possible.

GRIT GIB

Exceedingly sturdy machine base.

**For accessories, see page 273**

Weight	kg	17
Part number	9 90 01 003 00 0	
EAN	4014586859064	

FEIN BENEFITS

- + Work height can be adjusted conveniently by gas compression spring without effort
- + Low-vibration thanks to robust design
- + Combination possibilities with belt grinder GI 75 (2H) and GI 150 (2H)
- + Powder coating
- + Robust welded construction

GRIT GIBE

Exceedingly sturdy machine base with integrated double extraction.

**SUPPLIED**

2 hoses, 4 tensioning belts

For accessories, see page 273

Input	kW	0,35
Current/Voltages	220/230 & 400/440 V	
Air flow	l/min	13,300
Max. vacuum	hPa	4
Weight	kg	55
Part number	9 90 01 004 00 0	
EAN	4014586859071	

FEIN BENEFITS

- + Integrated metal swarf collector, resistant against hot sparks
- + Robust welded construction
- + Flexible, heat-resistant steel hoses
- + Cassette filter for effective filtering
- + Combination possibilities with belt grinder GI 75 (2H) and GI 150 (2H)
- + Powder coating

GRIT GIR

Radii-grinding module for precision fitting of pipes, profiles and flat materials in series application.

**SUPPLIED**1 contact roller Ø 42.4 mm,
1 grinding belt 150 x 2,250 mm
(K 36 R), 1 dust container**For accessories, see page 273**

Pipes up to Ø	mm	20 - 150
Belt size	mm	150 x 2,250
Dimension profiles / flat material max.	mm	120 x 150
Weight	kg	109
Part number	9 90 01 007 00 1	
EAN	4014586878263	

FEIN BENEFITS

- + For accurately grinding out radii (with a diameter of 20 to 193.7 mm) on pipes and profiles.
- + Contact rollers are optionally available in standard dimensions.
- + Integrated depth stop for the series application
- + Combination possibility with belt grinder GI 150 (2H)
- + Angle setting, individually possible up to 90°.

GRIT GIXBE**SUPPLIED**

1 hose, 1 tensioning belt,
1 CEE plug (16 A)

For accessories, see page 273

Integrated motor for effective suction.

Input	kW	0,37
Current/Voltages		3 x 400/440 V 50/60 Hz
Air flow	l/min	8,170
Speed, no load	rpm	1,500 / 3,000
Max. vacuum	hPa	2,65
Dimensions LxWxH	mm	305 x 575 x 700
Weight	kg	58

Part number	9 90 01 009 00 0
EAN	4014586859125

FEIN BENEFITS

- + Great steadiness because of bolting to the floor
- + Connection to integrated extraction possible.
- + Combination possibility with belt grinder Gi 100 (EF) and deburring machines GXE, GIE
- + Powder coating

GRIT GIXS

For accessories, see page 273

Sturdy machine base made of powder coated steel plate.

Dimensions LxWxH	mm	304 x 356 x 769
Weight	kg	18

Part number	9 90 01 002 00 0
EAN	4014586858340

FEIN BENEFITS

- + Great steadiness because of bolting to the floor
- + Combination possibility with belt grinder Gi 100 (EF) and deburring machines GXE, GIE
- + Powder coating
- + Steel plate model



	GRIT GKS 75	GRIT GKS 75	GRIT GKS 75	GRIT GKS 75	GRIT GKS 75 2H
--	-------------	-------------	-------------	-------------	----------------

Compact belt grinder for metalwork. The economical solution for the workshop.

		271	271	271	272	272
PAGE		271	271	271	272	272
Input	kW	4	1,1	1,5	3	1.5 / 2
Current/Voltages		3 x 400/440 V 50/60 Hz	1 x 230 V	3 x 400/440 V 50/60 Hz	3 x 400/440 V 50/60 Hz	3 x 400/440 V 50/60 Hz
Belt size	mm	75 x 2,000	75 x 2,000	75 x 2,000	75 x 2,000	75 x 2,000

GRIT GKS 75

Compact belt grinder for metalwork. The economical solution for the workshop.

Input	kW	4
Current/Voltages		3 x 400/440 V 50/60 Hz
Speed, no load	rpm	3,000
Belt size	mm	75 x 2,000
Weight	kg	50

Part number	7 905 01 00 40 3
EAN	4014586888255

FEIN BENEFITS

- + Very economical to buy as it offers optimum value for money.
- + Takes up 2/3 less space than standard tools thanks to its minimalistic design concept.
- + Can be used straight away. No assembly or installation work needed.
- + Short setup times - grinding belts can be rapidly exchanged.
- + Controlled sparking ensures maximum work safety.
- + Powerful motor for high sanding capacity.

SUPPLIED

1 grinding belt 75 x 2 000 mm
(K 36 R)

For accessories, see page 273

GRIT GKS 75

Compact belt grinder for metalwork. The economical solution for the workshop.

Input	kW	1,1
Current/Voltages		1 x 230 V
Speed, no load	rpm	3,000
Belt size	mm	75 x 2,000
Weight	kg	45

Part number	7 905 02 00 23 2
EAN	4014586888262

FEIN BENEFITS

- + Very economical to buy as it offers optimum value for money.
- + Takes up 2/3 less space than standard tools thanks to its minimalistic design concept.
- + Can be used straight away. No assembly or installation work needed.
- + Short setup times - grinding belts can be rapidly exchanged.
- + Controlled sparking ensures maximum work safety.

SUPPLIED

1 grinding belt 75 x 2 000 mm
(K 36 R)

For accessories, see page 273

GRIT GKS 75

Compact belt grinder for metalwork. The economical solution for the workshop.

Input	kW	1,5
Current/Voltages		3 x 400/440 V 50/60 Hz
Speed, no load	rpm	3,000
Belt size	mm	75 x 2,000
Weight	kg	45

Part number	7 905 02 00 40 3
EAN	4014586888279

FEIN BENEFITS

- + Very economical to buy as it offers optimum value for money.
- + Takes up 2/3 less space than standard tools thanks to its minimalistic design concept.
- + Can be used straight away. No assembly or installation work needed.
- + Short setup times - grinding belts can be rapidly exchanged.
- + Controlled sparking ensures maximum work safety.

SUPPLIED

1 grinding belt 75 x 2 000 mm
(K 36 R)

For accessories, see page 273

GRIT GKS 75

Compact belt grinder for metalwork. The economical solution for the workshop.



Input	kW	3
Current/Voltages		3 x 400/440 V 50/60 Hz
Speed, no load	rpm	3,000
Belt size	mm	75 x 2,000
Weight	kg	50

Part number	7 905 03 00 40 3
EAN	4014586888293

FEIN BENEFITS

- + Very economical to buy as it offers optimum value for money.
- + Takes up 2/3 less space than standard tools thanks to its minimalistic design concept.
- + Can be used straight away. No assembly or installation work needed.
- + Short setup times - grinding belts can be rapidly exchanged.
- + Controlled sparking ensures maximum work safety.
- + Powerful motor for high sanding capacity.

SUPPLIED

1 grinding belt 75 x 2 000 mm
(K 36 R)

For accessories, see page 273

GRIT GKS 75 2H

Compact belt grinder for metalwork. The economical solution for the workshop.



Input	kW	1.5 / 2
Current/Voltages		3 x 400/440 V 50/60 Hz
Speed, no load	rpm	1,500 / 3,000
Belt size	mm	75 x 2,000
Weight	kg	45

Part number	7 905 04 00 40 3
EAN	4014586888309

FEIN BENEFITS

- + Very economical to buy as it offers optimum value for money.
- + Takes up 2/3 less space than standard tools thanks to its minimalistic design concept.
- + Can be used straight away. No assembly or installation work needed.
- + Two speed settings deliver optimum speeds for metalworking and stainless steel processing.
- + Short setup times - grinding belts can be rapidly exchanged.
- + Controlled sparking ensures maximum work safety.
- + Powerful motor for high sanding capacity.

SUPPLIED

1 grinding belt 75 x 2 000 mm
(K 36 R)

For accessories, see page 273

GRINDING BELTS



3M™ CUBITRON™ II

Precision grinding belt with ceramic grain guarantees maximum performance and service life. The evenly shaped ceramic grains produce a uniquely accurate feel during machining. The result is cool grinding without tarnishing and better surface quality.

150 x 2,000 mm

Grain	No. in pack pcs	Part number
60	10	6 99 03 149 00 0
80	10	6 99 03 150 00 0



3M™ CUBITRON™ II

Precision grinding belt with ceramic grain guarantees maximum performance and service life. The evenly shaped ceramic grains produce a uniquely accurate feel during machining. The result is cool grinding without tarnishing and better surface quality.

150 x 2250 mm, for pipe notching with GRIT GIR module.

Grain	No. in pack pcs	Part number
36	10	6 99 03 154 00 0
60	10	6 99 03 155 00 0

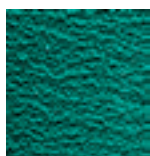

GRINDING MATERIAL R

It's the top grinding belt on the market, featuring superior service life and performance for considerably shorter working times. Especially recommended for machining stainless and high-alloy steel. Extra heavy polyester fabric, fully bonded with artificial resins, with zirconium corundum. Additional top layer for cooling during grinding.

75 x 2,000 mm

Grain	No. in pack pcs	Part number
24	10	6 99 03 000 00 0
36	10	6 99 03 002 00 0
40	10	6 99 03 004 00 0
60	10	6 99 03 007 00 0
80	10	6 99 03 009 00 0
120	10	6 99 03 013 00 0

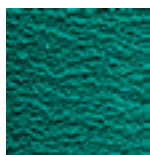

GRINDING MATERIAL R

It's the top grinding belt on the market, featuring superior service life and performance for considerably shorter working times. Especially recommended for machining stainless and high-alloy steel. Extra heavy polyester fabric, fully bonded with artificial resins, with zirconium corundum. Additional top layer for cooling during grinding.

75 x 2250 mm, for pipe notching with GRIT GXR module.

Grain	No. in pack pcs	Part number
36	10	6 99 03 020 00 0

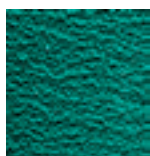

GRINDING MATERIAL R

It's the top grinding belt on the market, featuring superior service life and performance for considerably shorter working times. Especially recommended for machining stainless and high-alloy steel. Extra heavy polyester fabric, fully bonded with artificial resins, with zirconium corundum. Additional top layer for cooling during grinding.

75 x 2300 mm, for pipe notching with GRIT GXR module for contact rollers with diameter > 80 mm.

Grain	No. in pack pcs	Part number
36	10	6 99 03 122 00 0

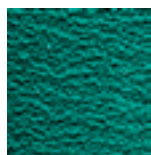

GRINDING MATERIAL R

It's the top grinding belt on the market, featuring superior service life and performance for considerably shorter working times. Especially recommended for machining stainless and high-alloy steel. Extra heavy polyester fabric, fully bonded with artificial resins, with zirconium corundum. Additional top layer for cooling during grinding.

150 x 2,000 mm

Grain	No. in pack pcs	Part number
24	10	6 99 03 039 00 0
36	10	6 99 03 040 00 0
40	10	6 99 03 042 00 0
60	10	6 99 03 044 00 0
80	10	6 99 03 046 00 0
120	10	6 99 03 048 00 0

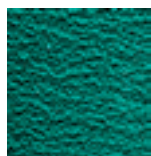

GRINDING MATERIAL R

It's the top grinding belt on the market, featuring superior service life and performance for considerably shorter working times. Especially recommended for machining stainless and high-alloy steel. Extra heavy polyester fabric, fully bonded with artificial resins, with zirconium corundum. Additional top layer for cooling during grinding.

150 x 2250 mm, for pipe notching with GRIT GIR module.

Grain	No. in pack pcs	Part number
36	10	6 99 03 053 00 0



GRINDING MATERIAL R

It's the top grinding belt on the market, featuring superior service life and performance for considerably shorter working times. Especially recommended for machining stainless and high-alloy steel. Extra heavy polyester fabric, fully bonded with artificial resins, with zirconium corundum. Additional top layer for cooling during grinding.

150 x 2400 mm, for pipe notching with GRIT GIR module for contact rollers with diameter > 170 mm.

Grain	No. in pack pcs	Part number
36	10	6 99 03 111 00 0

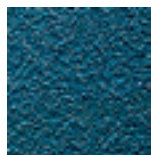

GRINDING MATERIAL Z

It's the all-rounder for grinding and deburring steel and non-ferrous metals which also satisfies the most stringent requirements. Developed in collaboration with professional users, this grinding material features an impressively long service life and high performance and is cost-effective to use. Heavy polyester fabric, fully bonded with artificial resins, with zirconium corundum.

75 x 2,000 mm

Grain	No. in pack pcs	Part number
36	10	6 99 03 003 00 0
40	10	6 99 03 005 00 0
60	10	6 99 03 008 00 0
80	10	6 99 03 010 00 0
120	10	6 99 03 014 00 0



GRINDING MATERIAL Z

It's the all-rounder for grinding and deburring steel and non-ferrous metals which also satisfies the most stringent requirements. Developed in collaboration with professional users, this grinding material features an impressively long service life and high performance and is cost-effective to use. Heavy polyester fabric, fully bonded with artificial resins, with zirconium corundum.

75 x 2250 mm, for pipe notching with GRIT GXR module.

Grain	No. in pack pcs	Part number
36	10	6 99 03 021 00 0



GRINDING MATERIAL Z

It's the all-rounder for grinding and deburring steel and non-ferrous metals which also satisfies the most stringent requirements. Developed in collaboration with professional users, this grinding material features an impressively long service life and high performance and is cost-effective to use. Heavy polyester fabric, fully bonded with artificial resins, with zirconium corundum. 100 x 1,000 mm

Grain	No. in pack pcs	Part number
36	10	6 99 03 034 00 0
40	10	6 99 03 035 00 0
60	10	6 99 03 036 00 0
80	10	6 99 03 037 00 0
120	10	6 99 03 038 00 0



GRINDING MATERIAL Z

It's the all-rounder for grinding and deburring steel and non-ferrous metals which also satisfies the most stringent requirements. Developed in collaboration with professional users, this grinding material features an impressively long service life and high performance and is cost-effective to use. Heavy polyester fabric, fully bonded with artificial resins, with zirconium corundum. 150 x 2,000 mm

Grain	No. in pack pcs	Part number
36	10	6 99 03 041 00 0
40	10	6 99 03 043 00 0
60	10	6 99 03 045 00 0
80	10	6 99 03 047 00 0
120	10	6 99 03 049 00 0



GRINDING MATERIAL Z

It's the all-rounder for grinding and deburring steel and non-ferrous metals which also satisfies the most stringent requirements. Developed in collaboration with professional users, this grinding material features an impressively long service life and high performance and is cost-effective to use. Heavy polyester fabric, fully bonded with artificial resins, with zirconium corundum. 150 x 2250 mm, for pipe notching with GRIT GIR module.

Grain	No. in pack pcs	Part number
36	10	6 99 03 054 00 0



GRINDING MATERIAL Z

It's the all-rounder for grinding and deburring steel and non-ferrous metals which also satisfies the most stringent requirements. Developed in collaboration with professional users, this grinding material features an impressively long service life and high performance and is cost-effective to use. Heavy polyester fabric, fully bonded with artificial resins, with zirconium corundum. 150 x 2400 mm, for pipe notching with GRIT GIR module for contact rollers with diameter > 170 mm.

Grain	No. in pack pcs	Part number
36	10	6 99 03 112 00 0



GRINDING MATERIAL A

Grinding belts with fine grit for fine grinding of metals to final finish. For the best surface results. Heavy cotton fabric, fully bonded with artificial resins, with corundum. 75 x 2,000 mm

Grain	No. in pack pcs	Part number
220	10	6 99 03 017 00 0
320	10	6 99 03 018 00 0
400	10	6 99 03 019 00 0



GRINDING MATERIAL A

Grinding belts with fine grit for fine grinding of metals to final finish. For the best surface results. Heavy cotton fabric, fully bonded with artificial resins, with corundum. 150 x 2,000 mm

Grain	No. in pack pcs	Part number
220	10	6 99 03 050 00 0
320	10	6 99 03 051 00 0
400	10	6 99 03 052 00 0

FLEECE STRIPS



FLEECE BELT

Reliable for everything from covering up minor mistakes to a perfect finish. Long service lives make for cost-effective working. 75 x 2,000 mm

Model	No. in pack pcs	Part number
very fine	3	6 99 03 121 01 0
medium	3	6 99 03 119 01 0
coarse	3	6 99 03 117 01 0



FLEECE BELT

Reliable for everything from covering up minor mistakes to a perfect finish. Long service lives make for cost-effective working. 150 x 2,000 mm

Model	No. in pack pcs	Part number
very fine	3	6 99 03 120 01 0
medium	3	6 99 03 118 01 0
coarse	3	6 99 03 116 01 0

ACCESSORIES FOR GRIT GX 75 / GX 75 2H



STAINLESS STEEL SANDING SUPPORT
GX 75

Part number	6 99 02 338 00 0
-------------	------------------



GRAPHITE PAD

As sliding base for surface grinding.

No. in pack pcs	Part number
5	3 90 00 000 00 1



EYE PROTECTION

Acrylic screen for protection against sparks

No. in pack pcs	Part number
3	3 90 00 000 00 4



SPARK BOX

with interfaces to extraction unit.

Part number	6 99 02 343 00 0
-------------	------------------

ACCESSORIES GRIT GXR

STAINLESS STEEL JAWS

Interchangeable, for vice when machining stainless steel.

Part number	6 99 02 004 00 0
-------------	------------------



LENGTH STOP

1000 mm long, continuously variable, easy to fit

Part number	6 99 02 001 00 0
-------------	------------------



CONTACT ROLLER

Long service lives, low roll resistance thanks to high-quality ball bearings, easy to interchange

Ø mm	Width mm	Part number
15	75	6 99 02 304 00 0
16	75	6 99 02 020 00 0
17	75	6 99 02 021 00 0
17,2	75	6 99 02 022 00 0
18	75	6 99 02 023 00 0
19	75	6 99 02 024 00 0
20	75	6 99 02 025 00 0
21	75	6 99 02 026 00 0
21,3	75	6 99 02 027 00 0
22	75	6 99 02 028 00 0
22,2	75	6 99 02 029 00 0
22,5	75	6 99 02 030 00 0
23	75	6 99 02 031 00 0
23,1	75	6 99 02 032 00 0
24	75	6 99 02 033 00 0
24,5	75	6 99 02 034 00 0
25	75	6 99 02 035 00 0
25,4	75	6 99 02 036 00 0
25,9	75	6 99 02 037 00 0
26	75	6 99 02 038 00 0
26,4	75	6 99 02 039 00 0
26,9	75	6 99 02 040 00 0
27	75	6 99 02 041 00 0
28	75	6 99 02 042 00 0
28,6	75	6 99 02 043 00 0
28,8	75	6 99 02 044 00 0
29	75	6 99 02 045 00 0
30	75	6 99 02 046 00 0
31	75	6 99 02 323 00 0
31,7	75	6 99 02 047 00 0
32	75	6 99 02 048 00 0
33	75	6 99 02 049 00 0
33,7	75	6 99 02 050 00 0
34	75	6 99 02 051 00 0
35	75	6 99 02 052 00 0
36	75	6 99 02 053 00 0
37,5	75	6 99 02 054 00 0
38	75	6 99 02 055 00 0
38,1	75	6 99 02 056 00 0
38,3	75	6 99 02 057 00 0
40	75	6 99 02 058 00 0
41	75	6 99 02 059 00 0
41,2	75	6 99 02 060 00 0
42	75	6 99 02 061 00 0
42,4	75	6 99 02 062 00 0
42,6	75	6 99 02 063 00 0
43	75	6 99 02 064 00 0
43,3	75	6 99 02 065 00 0
44	75	6 99 02 066 00 0
44,5	75	6 99 02 067 00 0
45	75	6 99 02 068 00 0
46	75	6 99 02 069 00 0
48	75	6 99 02 070 00 0
48,3	75	6 99 02 071 00 0
49	75	6 99 02 072 00 0
50	75	6 99 02 073 00 0
50,8	75	6 99 02 074 00 0
51	75	6 99 02 075 00 0
53	75	6 99 02 076 00 0
53,7	75	6 99 02 077 00 0
54	75	6 99 02 078 00 0
55	75	6 99 02 079 00 0

Ø mm	Width mm	Part number
57	75	6 99 02 080 00 0
57,5	75	6 99 02 324 00 0
58	75	6 99 02 081 00 0
59	75	6 99 02 082 00 0
60	75	6 99 02 083 00 0
60,3	75	6 99 02 084 00 0
63	75	6 99 02 085 00 0
63,5	75	6 99 02 086 00 0
65	75	6 99 02 087 00 0
67	75	6 99 02 088 00 0
68	75	6 99 02 326 00 0
69	75	6 99 02 089 00 0
70	75	6 99 02 090 00 0
73	75	6 99 02 091 00 0
75	75	6 99 02 092 00 0
76	75	6 99 02 093 00 0
76,1	75	6 99 02 094 00 0
76,2	75	6 99 02 095 00 0
80	75	6 99 02 096 00 0
82,5	75	6 99 02 097 00 0
84	75	6 99 02 327 00 0
88,9	75	6 99 02 098 00 0
90	75	6 99 02 099 00 0



EYE PROTECTION GU75/GR/GXR (3 PIECES)

Part number
3 90 00 000 00 7



DUST CONTAINER
Plastic, to douse sparks, with handles on the sides, capacity about 15 l

Part number
3 90 00 000 38 5

ACCESSORIES FOR MACHINES GXC



PIPE SUPPORT
Ø 10-130 mm

Part number
6 99 02 179 60 0



PIPE SUPPORT
Ø 10-160 mm
Can be combined with one another depending on the pipe length desired.

max. pipe length mm	Part number
1,000	6 99 02 180 60 0



PIPE SUPPORT
Ø 10-160 mm
Can be combined with one another depending on the pipe length desired.

max. pipe length mm	Part number
1,500	6 99 02 181 60 0



GUIDE RAIL, BRASS
For dry grinding and course material surfaces

Part number
3 90 00 000 49 6



NYLON GLIDE SUPPORT
For high surface quality

Part number
3 90 00 000 49 7

ACCESSORIES GRIT GXE



STAINLESS STEEL SANDING SUPPORT
GXE

Part number
6 99 02 344 00 0



STEEL WIRE BRUSH
Ø 250 mm x 60 mm, with very high wire drawing strength for highly efficient use, mounting hole Ø 51 mm. 0.2 mm thick wire for thin-walled pipes and profiles. 0.35 mm-thick wire for universal use. 0.5 mm thick wire for thick-walled pipes and profiles and great deburring results.
Steel version

Wire thickness mm	Part number
0,2	6 99 02 006 00 0
0,35	6 99 02 007 00 0
0,5	6 99 02 008 00 0



STEEL WIRE BRUSH
Ø 250 mm x 60 mm, with very high wire drawing strength for highly efficient use, mounting hole Ø 51 mm. 0.2 mm thick wire for thin-walled pipes and profiles. 0.35 mm-thick wire for universal use. 0.5 mm thick wire for thick-walled pipes and profiles and great deburring results.
Stainless steel version

Wire thickness mm	Part number
0,2	6 99 02 009 00 0
0,35	6 99 02 010 00 0



EYE PROTECTION
Acrylic screen for protection against sparks

No. in pack pcs	Part number
3	3 90 00 000 00 4

ACCESSORIES GRIT GXW



GRINDING/COOLING EMULSION
Concentrate, 10 l, mixing ratio 1:30, yields 300 l of ready-to-use cooling lubricant.

Part number
6 99 02 100 00 0

OTHER GRIT GX ACCESSORIES



HOSE
Flexible, for swarf extraction, 90 mm in diameter, 1 m long, steel, high level of heat resistance.

Part number
3 90 00 000 00 2



TUBE CLAMPS
For securing the flexible hose.

Part number
3 90 00 000 00 3



DUST CONTAINER
For extinguishing sparks, metal lid for hose connection, plastic, handles on the sides, capacity approx. 20 l.

Part number
6 99 02 000 00 0

ACCESSORIES FOR GRIT GI 75 / GI 75 2H



GRAPHITE PAD
As sliding base for surface grinding.

No. in pack pcs	Part number
5	3 90 00 000 00 1



EYE PROTECTION GU75/GR/GXR (3 PIECES)

Part number
3 90 00 000 00 7



MITRE JOINT UNIT FOR PREPARATION OF WELDED SEAMS
Fixture for chamfering workpieces to prepare welded seams. GI/GIS 75

Part number
6 99 02 000 15 0



STAINLESS STEEL SANDING SUPPORT
GI/GIS 75

Part number
6 99 02 000 14 8

ACCESSORIES FOR GRIT GI 150 / GI 150 2H



GRAPHITE COATING

Part number
3 90 00 000 05 6



MITRE JOINT UNIT FOR PREPARATION OF WELDED SEAMS

Fixture for chamfering workpieces to prepare welded seams.
GI/GIS 150

Part number

6 99 02 000 15 1



STAINLESS STEEL SANDING SUPPORT

GI/GIS 150

Part number

6 99 02 000 14 9



EYE PROTECTION

No. in pack
pcs

3

Part number

3 90 00 000 18 4

ACCESSORIES FOR GRIT GIR



CONTACT ROLLER

Long service lives, low roll resistance thanks to high-quality ball bearings, easy to interchange

Ø mm	Width mm	Part number
16	150	6 99 02 188 00 0
18	150	6 99 02 189 00 0
19	150	6 99 02 190 00 0
19,1	150	6 99 02 191 00 0
20	150	6 99 02 101 00 0
21	150	6 99 02 192 00 0
21,3	150	6 99 02 193 00 0
22	150	6 99 02 102 00 0
22,3	150	6 99 02 194 00 0
23	150	6 99 02 195 00 0
23,2	150	6 99 02 196 00 0
24,3	150	6 99 02 197 00 0
25	150	6 99 02 103 00 0
25,4	150	6 99 02 104 00 0
26,1	150	6 99 02 198 00 0
26,7	150	6 99 02 199 00 0
26,9	150	6 99 02 105 00 0
27	150	6 99 02 200 00 0
28	150	6 99 02 106 00 0
28,3	150	6 99 02 201 00 0
28,6	150	6 99 02 202 00 0
29,2	150	6 99 02 203 00 0
30	150	6 99 02 107 00 0
31,1	150	6 99 02 204 00 0
31,5	150	6 99 02 205 00 0
31,8	150	6 99 02 206 00 0
32	150	6 99 02 108 00 0
33	150	6 99 02 207 00 0
33,4	150	6 99 02 208 00 0
33,7	150	6 99 02 109 00 0
34	150	6 99 02 209 00 0
35	150	6 99 02 110 00 0
37,4	150	6 99 02 210 00 0
38	150	6 99 02 111 00 0
38,1	150	6 99 02 112 00 0
38,3	150	6 99 02 113 00 0
39,8	150	6 99 02 211 00 0
40	150	6 99 02 114 00 0
40,1	150	6 99 02 212 00 0

Ø mm	Width mm	Part number
41,3	150	6 99 02 213 00 0
42	150	6 99 02 214 00 0
42,1	150	6 99 02 215 00 0
42,2	150	6 99 02 216 00 0
42,4	150	6 99 02 115 00 0
43	150	6 99 02 217 00 0
44,5	150	6 99 02 116 00 0
45	150	6 99 02 218 00 0
45,7	150	6 99 02 219 00 0
47,4	150	6 99 02 221 00 0
48	150	6 99 02 222 00 0
48,3	150	6 99 02 117 00 0
49	150	6 99 02 223 00 0
50	150	6 99 02 118 00 0
50,1	150	6 99 02 224 00 0
50,8	150	6 99 02 119 00 0
51	150	6 99 02 225 00 0
53	150	6 99 02 226 00 0
54	150	6 99 02 229 00 0
55	150	6 99 02 230 00 0
57	150	6 99 02 231 00 0
57,8	150	6 99 02 232 00 0
58	150	6 99 02 233 00 0
59,5	150	6 99 02 234 00 0
60	150	6 99 02 120 00 0
60,3	150	6 99 02 121 00 0
62	150	6 99 02 235 00 0
63	150	6 99 02 236 00 0
63,5	150	6 99 02 122 00 0
64,2	150	6 99 02 237 00 0
65	150	6 99 02 238 00 0
66	150	6 99 02 239 00 0
66,3	150	6 99 02 240 00 0
66,7	150	6 99 02 241 00 0
67,1	150	6 99 02 242 00 0
68,9	150	6 99 02 332 00 0
69	150	6 99 02 123 00 0
69,9	150	6 99 02 243 00 0
70	150	6 99 02 244 00 0
73	150	6 99 02 245 00 0
73,8	150	6 99 02 246 00 0
75	150	6 99 02 247 00 0
75,1	150	6 99 02 248 00 0
76	150	6 99 02 249 00 0
76,2	150	6 99 02 125 00 0
78	150	6 99 02 250 00 0
79,4	150	6 99 02 251 00 0
79,8	150	6 99 02 252 00 0
80	150	6 99 02 253 00 0
80,2	150	6 99 02 254 00 0
81	150	6 99 02 255 00 0
82	150	6 99 02 256 00 0
82,1	150	6 99 02 257 00 0
82,5	150	6 99 02 258 00 0
83	150	6 99 02 259 00 0
84	150	6 99 02 126 00 0
84,1	150	6 99 02 260 00 0
85	150	6 99 02 261 00 0
86,7	150	6 99 02 262 00 0
87	150	6 99 02 263 00 0
88	150	6 99 02 264 00 0
88,9	150	6 99 02 127 00 0
89	150	6 99 02 265 00 0
89,3	150	6 99 02 266 00 0
89,9	150	6 99 02 267 00 0

Ø mm	Width mm	Part number
90,0	150	6 99 02 268 00 0
92,0	150	6 99 02 269 00 0
93,2	150	6 99 02 227 00 0
100,0	150	6 99 02 271 00 0
100,5	150	6 99 02 272 00 0
101,0	150	6 99 02 273 00 0
101,3	150	6 99 02 274 00 0
101,6	150	6 99 02 128 00 0
102,0	150	6 99 02 275 00 0
102,5	150	6 99 02 276 00 0
102,6	150	6 99 02 277 00 0
104,0	150	6 99 02 129 00 0
105,0	150	6 99 02 278 00 0
106,7	150	6 99 02 279 00 0
107,0	150	6 99 02 228 00 0
108,0	150	6 99 02 130 00 0
110,0	150	6 99 02 281 00 0
114,0	150	6 99 02 282 00 0
114,3	150	6 99 02 131 00 0
115,0	150	6 99 02 283 00 0
117,0	150	6 99 02 284 00 0
118,0	150	6 99 02 285 00 0
118,2	150	6 99 02 286 00 0
120,0	150	6 99 02 287 00 0
121,0	150	6 99 02 288 00 0
122,0	150	6 99 02 289 00 0
124,0	150	6 99 02 290 00 0
125,0	150	6 99 02 291 00 0
127,0	150	6 99 02 292 00 0
127,5	150	6 99 02 293 00 0
128,0	150	6 99 02 294 00 0
129,0	150	6 99 02 295 00 0
130,0	150	6 99 02 296 00 0
133,0	150	6 99 02 132 00 0
135,0	150	6 99 02 297 00 0
138,0	150	6 99 02 298 00 0
139,0	150	6 99 02 299 00 0
139,7	150	6 99 02 133 00 0
140,0	150	6 99 02 300 00 0
141,3	150	6 99 02 301 00 0
141,9	150	6 99 02 302 00 0
144,2	150	6 99 02 303 00 0
150,0	150	6 99 02 305 00 0
152,0	150	6 99 02 306 00 0
152,4	150	6 99 02 155 00 0
154,0	150	6 99 02 308 00 0
159,0	150	6 99 02 309 00 0
160,0	150	6 99 02 310 00 0
163,0	150	6 99 02 311 00 0
165,0	150	6 99 02 312 00 0
165,1	150	6 99 02 313 00 0
168,0	150	6 99 02 314 00 0
168,3	150	6 99 02 134 00 0
193,7	150	6 99 02 000 18 7

**EYE PROTECTION**No. in pack
pcs

Part number

3

3 90 00 000 18 4

**ADAPTOR**

For optimum extraction, for connection to the machine base GRIT GIBE with double extraction.

Part number

6 99 02 182 00 0

ACCESSORIES FOR GRIT GIE**STEEL WIRE BRUSH**

Ø 250 mm x 60 mm, with very high wire drawing strength for highly efficient use, mounting hole Ø 51 mm. 0.2 mm thick wire for thin-walled pipes and profiles. 0.35 mm-thick wire for universal use. 0.5 mm thick wire for thick-walled pipes and profiles and great deburring results.

Steel version

Wire thickness
mm

Part number

0,2

6 99 02 006 00 0

0,35

6 99 02 007 00 0

0,5

6 99 02 008 00 0

**STEEL WIRE BRUSH**

Ø 250 mm x 60 mm, with very high wire drawing strength for highly efficient use, mounting hole Ø 51 mm. 0.2 mm thick wire for thin-walled pipes and profiles. 0.35 mm-thick wire for universal use. 0.5 mm thick wire for thick-walled pipes and profiles and great deburring results.

Stainless steel version

Wire thickness
mm

Part number

0,2

6 99 02 009 00 0

0,35

6 99 02 010 00 0

**EYE PROTECTION GU75/GR/GXR (3 PIECES)**

Part number

3 90 00 000 00 7

**CASSETTE FILTER**

Suitable for GRIT GIBE.

Part number

3 90 00 000 97 6

**METAL FILTER**

Suitable for GRIT GIBE.

Part number

3 90 00 000 10 0

**STAINLESS STEEL SANDING SUPPORT**

GIE

Part number

3 90 00 009 92 3

GRIT GIC ACCESSORIES



PIPE SUPPORT

Ø 10-160 mm
Can be combined with one another depending on the pipe length desired.

max. pipe length mm	Part number
1,000	6 99 02 180 60 0



PIPE SUPPORT

Ø 10-160 mm
Can be combined with one another depending on the pipe length desired.

max. pipe length mm	Part number
1,500	6 99 02 181 60 0



PIPE CLEANING UNIT

For a clean and dry working environment. The coolant is wiped off the pipe surface without the pipe being scratched. For pipes with a diameter of between 10 and 130 mm. Easy to fit on GIC.

Part number
6 99 02 000 14 6



GUIDE RAIL, BRASS

For dry grinding and course material surfaces

Part number
3 90 00 000 49 6



NYLON GLIDE SUPPORT

For high surface quality

Part number
3 90 00 000 49 7



GRINDING/COOLING EMULSION

Concentrate, 10 l, mixing ratio 1:30, yields 300 l of ready-to-use cooling lubricant.

Part number
6 99 02 100 00 0

GRIT GIL ACCESSORIES



GRAPHITE PAD

As sliding base for surface grinding.

No. in pack pcs	Part number
4	3 90 00 004 76 0

OTHER ACCESSORIES GRIT GI



HOSE

Flexible, for swarf extraction, 90 mm in diameter, 1 m long, steel, high level of heat resistance.

Part number
3 90 00 000 00 2



TUBE CLAMPS

For securing the flexible hose.

Part number
3 90 00 000 00 3



DUST CONTAINER

Plastic, to douse sparks, with handles on the sides, capacity about 15 l

Part number
3 90 00 000 38 5



DUST CONTAINER

For extinguishing sparks, metal lid for hose connection, plastic, handles on the sides, capacity approx. 20 l.

Part number
6 99 02 000 00 0

DRIVE WHEEL PULLER

Part number
6 99 02 410 00 0



SWIVEL JOINT GIT

For adapting working area to tight spaces, continuously variable swivel range of up to 90°.

Part number
6 99 02 176 00 0



PLUGBOX 2 X 7 POLES

Part number
6 99 02 183 00 0

GRIT GI 100 ACCESSORIES

GRAPHITE COATING



Part number
3 90 00 000 18 3



EYE PROTECTION

Acrylic screen for protection against sparks

No. in pack pcs	Part number
3	3 90 00 000 19 0



ACCESSORIES

BALANCERS **282**

Balancers increase operating comfort and safety.
For loads of 0.5 kg - 60 kg.

BALANCER UP TO 1.5 KG

BALANCER UP TO 2,5 KG



Safe suspension of device and power line in "weightless" state.

Variable load	kg	0.5 - 1.5	1.5 - 2.5
Factory setting	kg	1	2
max. stroke	m	0,9	0,9
Model		Stable nylon cable	Stable nylon cable
Weight	kg	0,35	0,35

- FEIN BENEFITS**
- + Small size.
 - + Constant traction.
 - + Easily adjustable.
 - + Stable nylon cable.
 - + Spiral cordset available as accessory

Part number	9 08 01 012 00 8	9 08 01 023 00 1
EAN	4014586835075	4014586835099

For accessories, see page 284

BALANCER UP TO 1.5 KG

BALANCER UP TO 2,5 KG



Safe suspension of device and power line in "weightless" state.

Variable load	kg	0.5 - 1.5	1.5 - 2.5
Factory setting	kg	1	2
max. stroke	m	0,9	0,9
Model		Wire cable	Wire cable
Weight	kg	0,35	0,35

- FEIN BENEFITS**
- + Constant traction.
 - + Tear-resistant steel cable.
 - + Spiral cordset available as accessory

Part number	9 08 01 052 00 4	9 08 01 037 00 9
EAN	4014586854052	4014586835228

For accessories, see page 284

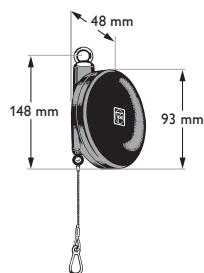

Balancer up to 1,5 kg
Balancer up to 2,5 kg

BALANCER UP TO 3 KG BALANCER UP TO 5 KG BALANCER UP TO 6,5 KG

Safe suspension of device and power line in "weightless" state.

Variable load	kg	1 - 3	2,5 - 5	3,5 - 6,5
Factory setting	kg	2	3,5	5
max. stroke	m	2	2	2
Model		Wire cable	Wire cable	Wire cable
Weight	kg	3,2	3,2	3,2

FEIN BENEFITS

- + Constant traction.
- + Tear-resistant steel cable.
- + Spiral cordset available as accessory

Part number	9 08 01 024 00 9	9 08 01 025 00 3	9 08 01 026 00 6
EAN	4014586835105	4014586835136	4014586835143

For accessories, see page 284

BALANCER UP TO 9 KG
BALANCER UP TO 11 KG
BALANCER UP TO 14 KG
BALANCER UP TO 17 KG

Safe suspension of device and power line in "weightless" state.

Variable load	kg	4,5 - 9	7,5 - 11	10 - 14	13,5 - 17
Factory setting	kg	7	9	12	15
max. stroke	m	2	2	2	2
Model		Wire cable	Wire cable	Wire cable	Wire cable
Weight	kg	3,2	3,2	3,2	3,2

FEIN BENEFITS

- + Constant traction.
- + Tear-resistant steel cable.
- + Spiral cordset available as accessory

Part number	9 08 01 027 00 0	9 08 01 028 00 8	9 08 01 029 00 2	9 08 01 030 00 4
EAN	4014586835150	4014586835167	4014586835174	4014586835181

For accessories, see page 284

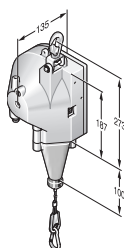

Balancer up to 3 kg
 Balancer up to 5 kg
 Balancer up to 6,5 kg
 Balancer up to 9 kg
 Balancer up to 11 kg
 Balancer up to 14 kg
 Balancer up to 17 kg

BALANCER UP TO 25 KG



BALANCER UP TO 32 KG



BALANCER UP TO 45 KG



BALANCER UP TO 60 KG



Safe suspension of device and power line in "weightless" state.

Variable load	kg	13 - 25	22 - 32	30 - 45	45 - 60
Factory setting	kg	15	25	40	50
max. stroke	m	1,9	1,9	1,9	1,9
Model		Wire cable	Wire cable	Wire cable	Wire cable
Weight	kg	11,2	11,5	12	12,4

- FEIN BENEFITS**
- + Constant traction.
 - + Tear-resistant steel cable.
 - + Spiral cordset available as accessory

Part number	9 08 01 055 00 0	9 08 01 056 00 0	9 08 01 057 00 0	9 08 01 058 00 0
EAN	4014586880693	4014586880709	4014586880716	4014586880723

For accessories, see page 284

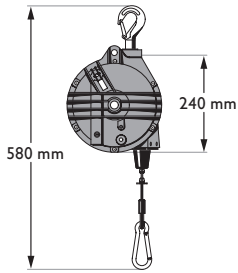

Balancer up to 25 kg
 Balancer up to 32 kg
 Balancer up to 45 kg
 Balancer up to 60 kg

GENERAL ACCESSORIES



SPIRAL CORDSET
 for electric tools with mains connection cables of quality HO 5 RN-F 2 x 1.

Part number
 3 07 07 157 03 5

BALANCER UP TO 60 KG



LOCKING DEVICE
 for locking the extended cable. eases the exchange of the hooked on tool.

Part number
 3 02 40 239 01 4



SWIVEL HOOK
 to hook on the rope eye. Prevents the rope from twisting.

Part number
 3 02 32 044 01 0

Part number	EAN	Description	PC	Page
7 105 03 62 00 0	4014586881768	ABOP 13-2 Select	01	22
7 105 04 62 00 0	4014586881775	AWBP 10 Select	01	32
7 109 01 62 00 0	4014586885537	AGWP 10 Select	01	34
7 112 62 60 00 0	4014586883830	ASW 18-30 PC	05	57
7 112 63 60 00 0	4014586883847	ASW 18-45 PC	05	57
7 112 64 60 00 0	4014586883854	ASW 18-60 PC	05	57
7 112 66 60 00 0	4014586887920	ASW 18-6 PC	05	56
7 112 68 60 00 0	4014586887968	ASW 18-12 PC	05	56
7 112 70 60 00 0	4014586888002	ASW 18-18 PC	05	56
7 112 77 60 00 0	4014586891422	ASM 18-3 PC	05	55
7 112 78 60 00 0	4014586891446	ASM 18-8 PC	05	55
7 112 79 60 00 0	4014586891460	ASM 18-12 PC	05	55
7 113 11 63 00 0	4014586881461	ASCS 6.3 Select	01	60
7 113 16 64 00 0	4014586887555	ASCT 18 M Select	01	63
7 113 16 65 00 0	4014586887562	ASCT 18 Select	01	63
7 113 20 64 00 0	4014586885568	ABSU 12 Select	18	46
7 113 21 64 00 0	4014586885575	ABSU 12 W4 Select	18	46
7 113 22 64 00 0	4014586887203	ABS 18 Q Select	18	44
7 113 23 64 00 0	4014586887265	ASB 18 Q Select	18	44
7 115 03 64 00 0	4014586885582	ASCD 12-100 W4 Select	18	52
7 115 04 64 00 0	4014586887388	ASCD 12-150 W8 Select	18	52
7 115 05 64 00 0	4014586887401	ASCD 12-150 W4 Select	18	52
7 115 06 64 00 0	4014586887425	ASCD 18-300 W2 Select	18	51
7 115 07 64 00 0	4014586887449	ASCD 18-200 W4 Select	18	51
7 115 08 64 00 0	4014586891651	ASCD 18-1000 W34 Select	18	51
7 116 10 64 00 0	4014586885698	ASCM 12 Q Select	18	45
7 116 11 64 00 0	4014586887340	ASCM 18 QM Select	18	43
7 116 12 64 00 0	4014586889900	ASCM 18 QSW Select	18	43
7 120 01 62 00 0	4014586888408	CCG 18-115 BL Select	01	69
7 120 02 62 00 0	4014586888460	CCG 18-125 BL Select	01	69
7 120 03 62 00 0	4014586888514	CCG 18-115 BLPD Select	01	70
7 120 04 62 00 0	4014586888576	CCG 18-125 BLPD Select	01	70
7 123 01 62 00 0	4014586888637	AGSZ 18-280 BL Select	01	94
7 123 02 62 00 0	4014586888699	AGSZ 18-280 LBL Select	01	94
7 123 03 62 00 0	4014586888750	AGSZ 18-90 LBL Select	01	94
7 129 32 61 00 0	4014586892955	Cordless MULTIMASTER AMM 300 Plus Start	03	222
7 129 32 62 00 0	4014586893013	Cordless MULTIMASTER AMM 300 Plus Select	03	222
7 129 33 61 00 0	4014586893037	Cordless MULTIMASTER AMM 500 Plus Top	03	223
7 129 33 62 00 0	4014586893099	Cordless MULTIMASTER AMM 500 Plus Select	03	223
7 129 34 61 00 0	4014586893112	Cordless MULTIMASTER AMM 700 Max Top	03	225
7 129 34 62 00 0	4014586893174	Cordless MULTIMASTER AMM 700 Max Select	03	225
7 129 35 61 00 0	4014586893198	Cordless MULTIMASTER AMM 700 1.7 Q Select	03	247
7 129 35 62 00 0	4014586893211	Cordless MULTIMASTER AMM 700 1.7 Q Autoglas	03	247
7 130 03 61 00 0	4014586886640	ABSS 18 1.6 E Select	01	119
7 130 04 61 00 0	4014586886664	ABLS 18 1.6 E Select	01	123
7 132 04 61 00 0	4014586886688	ABLK 18 1.6 E Select	01	129
7 132 05 61 00 0	4014586886701	ABLK 18 1.3 CSE Select	01	128
7 132 06 61 00 0	4014586886725	ABLK 18 1.3 TE Select	01	128
7 138 01 61 00 0	4014586892665	AKFH 18-5 Select	01	147
7 140 01 64 00 0	4014586889214	ABH 18 Select	01	31
7 170 01 62 00 0	4014586889108	AKBU 35 PMQ Select	01	167
7 170 02 62 00 0	4014586889122	AKBU 35 PMQW Select	01	167
7 202 51 60 00 0	4014586889849	BOZ 32-4 M	01	28
7 205 47 60 00 0	4014586874463	BOS 16	01	27
7 205 49 60 00 0	4014586876443	BOS 16-2	01	27
7 205 51 60 00 0	4014586878843	WBP 10	01	32
7 205 52 60 00 0	4014586882413	BOP 6	01	23
7 205 52 61 00 0	4014586881973	BOP 6 set	01	23
7 205 53 60 00 0	4014586882468	BOP 10	01	24
7 205 53 61 00 0	4014586881980	BOP 10 set	01	24
7 205 54 60 00 0	4014586882512	BOP 10-2	01	25

Part number	EAN	Description	PC	Page
7 205 54 61 00 0	4014586881997	BOP 10-2 set	01	25
7 205 55 60 00 0	4014586882567	BOP 13-2	01	26
7 205 55 61 00 0	4014586882017	BOP 13-2 set	01	26
7 209 38 60 00 0	4014586881256	GWP 10	01	34
7 213 04 00 23 9	4014586853734	SCS 4.8-25	01	60
7 213 06 50 01 8	4014586854205	SCT 5-40 M	01	64
7 213 08 50 01 0	4014586854373	SCT 5-40 UM	01	-
7 213 13 00 23 0	4014586860923	SCT 5-40 X	01	63
7 213 14 00 23 0	4014586860930	SCT 5-40 UX	01	64
7 221 05 00 23 7	4014586851242	WSB 20-180	01	86
7 221 05 29 23 2	4014586851792	WSB 20-180	01	86
7 221 06 00 23 0	4014586851259	WSB 20-230	01	87
7 221 06 29 23 5	4014586851815	WSB 20-230	01	87
7 221 07 00 23 6	4014586851266	WSG 20-180	01	86
7 221 08 00 23 2	4014586851273	WSG 20-230	01	87
7 221 08 29 23 7	4014586851853	WSG 20-230	01	87
7 221 10 00 23 3	4014586853116	WSB 25-180 X	01	88
7 221 10 29 23 8	4014586853246	WSB 25-180 X	01	88
7 221 11 00 23 2	4014586853123	WSB 25-230 X	01	89
7 221 11 29 23 7	4014586853314	WSB 25-230 X	01	89
7 221 26 00 23 0	4014586856452	WSG 25-180	01	88
7 221 26 29 23 0	4014586856490	WSG 25-180	01	88
7 221 27 00 23 0	4014586856506	WSG 25-230	01	89
7 221 27 29 23 0	4014586856544	WSG 25-230	01	89
7 221 31 00 23 0	4014586858371	MSfv 649-1	01	83
7 221 48 00 23 0	4014586862699	WPO 14-15 E	01	212
7 221 48 50 01 0	4014586862712	WPO 14-15 E marine polishing set	01	213
7 221 48 51 01 0	4014586867069	WPO 14-15 E Set	01	212
7 221 48 60 00 0	4014586872216	WPO 14-15 E marine polishing set	01	212
7 221 49 00 23 0	4014586862729	WPO 14-25 E	01	201
7 221 49 50 01 0	4014586862743	WPO 14-25 E - Stainless steel start set	01	201
7 221 49 51 01 0	4014586867113	WPO 14-25 E	01	213
7 221 63 00 23 0	4014586866055	WPO 10-25 E	01	214
7 221 63 51 01 0	4014586867199	WPO 10-25 E Set	01	214
7 221 67 60 00 0	4014586868936	KS 10-38 E set	01	202
7 221 73 60 00 0	4014586875033	WSG 8-115	19	75
7 221 74 60 00 0	4014586875125	WSG 8-125	19	75
7 221 75 60 00 0	4014586875217	WSG 12-125 P	19	76
7 221 76 60 00 0	4014586875309	WSG 12-125 PQ	19	-
7 221 77 60 00 0	4014586875316	WSG 11-125	19	76
7 221 78 60 00 0	4014586875323	WSG 15-125 P	19	77
7 221 79 60 00 0	4014586875330	WSG 15-125 PQ	19	-
7 221 87 60 00 0	4014586879888	WSG 11-125 RT	19	76
7 221 90 60 00 0	4014586879970	WSG 15-125 PR	19	77
7 221 91 60 00 0	4014586880020	WSG 15-125 PRT	19	77
7 221 98 60 00 0	4014586885506	WSG 7-115	19	74
7 222 07 60 00 0	4014586883120	WSG 17-125 P	19	78
7 222 08 60 00 0	4014586883175	WSG 17-125 PQ	19	-
7 222 09 60 00 0	4014586883236	WSG 17-125 PS	19	78
7 222 10 60 00 0	4014586883304	WSG 17-125 PSQ	19	-
7 222 11 60 00 0	4014586883366	WSG 17-150 P	19	79
7 222 12 60 00 0	4014586883434	WSG 17-150 PQ	19	-
7 222 13 60 00 0	4014586883496	WSG 17-70 Inox	19	80
7 222 13 61 00 0	4014586883564	WSG 17-70 Inox starter set	19	201
7 222 18 60 00 0	4014586883571	WSG 17-125 PR	19	78
7 222 19 60 00 0	4014586883618	WSG 17-125 PRT	19	78
7 222 20 60 00 0	4014586883656	WSG 17-150 PR	19	79
7 222 21 60 00 0	4014586883694	WSG 17-150 PRT	19	79
7 222 22 60 00 0	4014586883731	WSG 17-70 Inox R	19	80
7 222 23 60 00 0	4014586883779	WSG 17-70 Inox RT	19	80
7 222 65 60 00 0	4014586891477	WSG 7-125	19	74

Part number	EAN	Description	PC	Page
7 223 16 60 00 0	4014586879505	GSZ 8-280 P	01	96
7 223 17 60 00 0	4014586879437	GSZ 8-280 PE	01	96
7 223 19 60 00 0	4014586879444	GSZ 8-280 PEL	01	97
7 223 20 60 00 0	4014586879451	GSZ 8-90 PEL	01	97
7 223 22 60 00 0	4014586880501	GSZ 11-320 PERL	01	98
7 223 23 60 00 0	4014586880525	GSZ 11-90 PERL	01	98
7 223 24 60 00 0	4014586880594	GSZ 4-280 EL	01	95
7 223 25 60 00 0	4014586880648	GSZ 4-90 EL	01	95
7 228 05 50 00 0	4014586867250	BF 10-280 E	01	202
7 228 05 51 00 0	4014586867267	BF 10-280 E Start-Set	01	202
7 229 67 61 00 0	4014586893235	MULTIMASTER MM 500 Plus Top	03	224
7 229 67 62 00 0	4014586893310	MULTIMASTER MM 500 Plus	03	224
7 229 68 61 00 0	4014586893396	MULTIMASTER MM 700 Max Top	03	226
7 229 68 62 00 0	4014586893471	MULTIMASTER MM 700 Max	03	226
7 229 69 61 00 0	4014586893556	MULTIMASTER MM 700 1.7 Basic	03	248
7 229 70 61 00 0	4014586893594	MULTIMASTER MM 700 1.7 Q Basic	03	248
7 229 70 62 00 0	4014586893662	MULTIMASTER MM 700 1.7 Q Autoglas	03	248
7 229 70 63 00 0	4014586893709	MULTIMASTER MM 700 1.7 Q Bus & Truck	03	249
7 229 72 61 00 0	4014586893747	MULTIMASTER MM 300 Plus Start	03	222
7 230 31 61 00 0	4014586874661	BSS 1.6 E	01	119
7 230 32 61 00 0	4014586874739	BSS 1.6 CE	01	119
7 230 33 61 00 0	4014586874807	BSS 2.0 E	01	120
7 230 34 61 00 0	4014586874876	BLS 1.6 E	01	123
7 230 35 61 00 0	4014586874944	BLS 2.5 E	01	123
7 232 30 00 23 0	4014586848655	BLK 3.5	01	132
7 232 31 00 23 9	4014586848662	BLK 5.0	01	132
7 232 38 60 00 0	4014586869858	BLK 1.6 E	01	130
7 232 39 60 00 0	4014586869926	BLK 1.6 LE	01	131
7 232 40 60 00 0	4014586869995	BLK 2.0 E	01	131
7 232 41 60 00 0	4014586870069	BLK 1.3 TE	01	130
7 232 42 60 00 0	4014586870137	BLK 1.3 CSE	01	129
7 234 15 00 23 0	4014586839332	ASte 638	01	139
7 234 17 00 23 9	4014586841670	ASt 638	01	139
7 234 22 00 23 0	4014586858470	AStx 649-1	01	142
7 234 23 00 23 0	4014586858500	AStxe 649-1	01	142
7 236 54 60 00 0	4014586894447	MKAS 355	01	145
7 238 16 61 00 0	4014586892696	KFH 17-8 R	01	147
7 238 18 61 00 0	4014586892733	KFH 17-15 R	01	147
7 245 01 60 00 0	4014586894331	GRIT GHB 15-50	01	256
7 245 02 60 00 0	4014586894362	GRIT GHB 15-50 Inox	01	256
7 270 40 61 00 0	4014586872995	KBM 50 U	01	172
7 270 41 61 00 0	4014586872834	KBM 50 Q	01	172
7 270 42 61 00 0	4014586874272	KBM 50 auto	01	175
7 270 43 61 00 0	4014586872902	KBM 65 U	01	173
7 270 50 60 00 0	4014586881584	KBE 35	01	158
7 270 51 60 00 0	4014586881645	KBE 50-2	01	158
7 270 53 61 00 0	4014586886039	KBU 35 Q	01	168
7 270 54 61 00 0	4014586886763	KBU 35 QW	01	168
7 270 55 61 00 0	4014586886053	KBU 35 MQ	01	171
7 270 56 61 00 0	4014586886770	KBU 35 MQW	01	171
7 270 57 61 00 0	4014586886077	KBU 35-2 Q	01	170
7 270 58 61 00 0	4014586886787	KBU 35-2 QW	01	170
7 270 60 61 00 0	4014586889740	KBU 110-4 M	01	173
7 270 65 60 00 0	4014586889597	KBE 30	01	157
7 270 71 61 00 0	4014586890524	KBU 35 PQ	01	169
7 270 72 61 00 0	4014586890548	KBU 35 PQW	01	169
7 270 94 61 00 0	4014586894539	KBE 32	01	157
7 270 95 61 00 0	4014586894614	KBE 32 QW	01	157
7 272 03 61 00 0	4014586700502	KBB 40	01	160
7 534 08 00 00 0	4014586855639	STS 325 R	01	142
7 536 03 00 01 0	4014586861906	MOtlx 6-25	03	249

Part number	EAN	Description	PC	Page
7 820 02 00 26 8	4014586823874	MSfov 852 300 Hz 200 V	09	-
7 820 43 00 26 5	4014586826646	MSfo 869d 300 Hz 200 V	09	-
7 820 62 00 22 0	4014586856742	MSfo 869-1c 300 Hz 72 V	09	-
7 820 62 00 26 0	4014586856759	MSfo 869-1c 300 Hz 200 V	09	104
7 820 63 00 12 0	4014586856797	MSfo 869-1c 200 Hz 72 V	09	-
7 820 63 00 20 0	4014586856803	MSfo 869-1c 200 Hz 265 V	09	-
7 820 64 00 12 0	4014586856810	MSfo 869-1d 200 Hz 72 V	09	-
7 820 64 00 17 0	4014586860206	MSfo 869-1d 200 Hz 135 V	09	-
7 820 64 00 20 0	4014586856827	MSfo 869-1d 200 Hz 265 V	09	-
7 820 65 00 22 0	4014586860664	MSfo 869-1d 300 Hz 72 V	09	-
7 820 65 00 26 0	4014586856834	MSfo 869-1d 300 Hz 200 V	09	104
7 820 70 00 20 0	4014586856926	MSfo 852-1c 200 Hz 265 V	09	-
7 820 71 00 26 0	4014586856933	MSfo 852-1c 300 Hz 200 V	09	103
7 820 72 00 20 0	4014586856964	MSfo 852-1d 200 Hz 265 V	09	-
7 820 73 00 26 0	4014586856971	MSfo 852-1d 300 Hz 200 V	09	103
7 820 74 00 20 0	4014586857022	MSfo 870-1c 200 Hz 265 V	09	-
7 820 75 00 26 0	4014586857053	MSfo 870-1c 300 Hz 200 V	09	105
7 820 77 00 26 0	4014586857107	MSfo 870-1d 300 Hz 200 V	09	105
7 820 79 00 20 0	4014586857138	MSfo 849-1c 200 Hz 265 V	09	-
7 820 80 00 26 0	4014586857145	MSfo 849-1c 300 Hz 200 V	09	102
7 820 81 00 20 0	4014586857275	MSf 843-1a 200 Hz 265 V	09	-
7 820 81 99 20 0	4014586857282	MSf 843-1a 200 Hz 265 V	09	-
7 820 82 00 12 0	4014586857299	MSfov 852-1 200 Hz 72 V	09	-
7 820 82 00 17 0	4014586857305	MSfov 852-1 200 Hz 135 V	09	-
7 820 82 00 20 0	4014586857312	MSfov 852-1 200 Hz 265 V	09	-
7 820 83 00 22 0	4014586857329	MSfov 852-1 300 Hz 72 V	09	-
7 820 83 00 26 0	4014586857336	MSfov 852-1 300 Hz 200 V	09	103
7 820 85 00 26 0	4014586864402	MSf 843-1c 300 Hz 200 V	09	102
7 820 86 60 00 0	4014586869513	HFW 9-125 300 Hz 200 V	09	102
7 820 87 60 00 0	4014586886022	MSfov 852-1-180 300 Hz 200 V	09	103
7 823 03 00 17 2	4014586827575	MSho 840-2 200 Hz 135 V	09	-
7 823 03 00 20 4	4014586827599	MSho 840-2 200 Hz 265 V	09	-
7 823 03 00 22 9	4014586827612	MSho 840-2 300 Hz 72 V	09	-
7 823 03 00 26 0	4014586827636	MSho 840-2 300 Hz 200 V	09	109
7 823 19 00 20 0	4014586857923	MSh 843-1 200 Hz 265 V	09	-
7 823 19 00 22 0	4014586857930	MSh 843-1 300 Hz 72 V	09	-
7 823 19 00 26 0	4014586857947	MSh 843-1 300 Hz 200 V	09	110
7 823 20 00 12 0	4014586857978	MSho 849-1z 200 Hz 72 V	09	-
7 823 20 00 20 0	4014586857992	MSho 849-1z 200 Hz 265 V	09	-
7 823 20 00 22 0	4014586858005	MSho 849-1z 300 Hz 72 V	09	-
7 823 20 00 26 0	4014586858012	MSho 849-1z 300 Hz 200 V	09	110
7 823 22 00 26 0	4014586860015	MSho 852-1ZV 300 Hz 200 V	09	-
7 824 37 00 22 0	4014586858081	MShyo 869-1a 300 Hz 72 V	09	-
7 824 37 00 26 0	4014586857633	MShyo 869-1a 300 Hz 200 V	09	108
7 824 38 00 26 0	4014586858111	MShyo 869-1d 300 Hz 200 V	09	108
7 824 39 00 12 0	4014586858128	MShyo 852-3a 200 Hz 72 V	09	-
7 824 39 00 17 0	4014586871714	MShyo 852-3a 200 Hz 135 V	09	-
7 824 39 00 20 0	4014586857640	MShyo 852-3a 200 Hz 265 V	09	-
7 824 39 00 22 0	4014586858135	MShyo 852-3a 300 Hz 72 V	09	-
7 824 39 00 26 0	4014586857657	MShyo 852-3a 300 Hz 200 V	09	109
7 824 40 00 26 0	4014586858180	MShyo 852-4a 300 Hz 200 V	09	108
7 824 41 00 20 0	4014586858210	MSho 852-1 200 Hz 265 V	09	-
7 824 42 00 22 0	4014586858234	MSho 852-1 300 Hz 72 V	09	-
7 824 42 00 26 0	4014586858241	MSho 852-1 300 Hz 200 V	09	109
7 901 05 00 40 3	4014586857879	GRIT GXE	13	261
7 901 23 00 44 3	4014586871936	GRIT GXC	13	261
7 901 24 00 44 3	4014586873145	GRIT GXW	13	261
7 901 31 00 40 3	4014586872018	GRIT GX 75	13	260
7 901 32 00 40 3	4014586872063	GRIT GX 75 2H	13	260
7 902 01 00 40 3	4014586858913	GRIT GI 75	13	263
7 902 02 00 40 3	4014586858944	GRIT GI 75 2H	13	263

Part number	EAN	Description	PC	Page
7 902 04 00 40 3	4014586858999	GRIT GI 150	13	264
7 902 05 00 40 3	4014586859019	GRIT GI 150 2H	13	264
7 902 07 00 40 3	4014586859057	GRIT GIE	13	265
7 902 12 00 44 3	4014586867656	GRIT GIC	13	265
7 902 13 00 40 3	4014586872599	GRIT GIMS 75	13	265
7 902 14 00 40 3	4014586872643	GRIT GIMS 150	13	265
7 902 16 00 40 3	4014586878614	GIMS 75 2H	13	266
7 902 17 00 40 3	4014586878621	GIMS 150 2H	13	266
7 902 18 00 40 3	4014586878645	GIMS 75-6	13	266
7 902 19 00 40 3	4014586878683	GIMS 150-6	13	266
7 902 23 00 23 2	4014586887043	GRIT GI 100 EF	13	263
7 902 23 00 40 3	4014586887067	GRIT GI 100	13	263
7 902 29 50 44 3	4014586878126	GRIT GIS 75	13	264
7 902 30 50 44 3	4014586878225	GRIT GIS 150	13	264
7 902 35 00 40 3	4014586880921	GRIT GILSGIB	13	267
7 902 48 00 40 3	4014586880945	GRIT GIL	13	267
7 902 51 00 40 3	4014586880976	GRIT GILS	13	267
7 905 01 00 40 3	4014586888255	GRIT GKS 75	13	271
7 905 02 00 23 2	4014586888262	GRIT GKS 75	13	271
7 905 02 00 40 3	4014586888279	GRIT GKS 75	13	271
7 905 03 00 40 3	4014586888293	GRIT GKS 75	13	272
7 905 04 00 40 3	4014586888309	GRIT GKS 75 2H	13	272
9 03 16 223 00 8	4014586847924	MBS 32 F	01	38
9 03 18 223 00 0	4014586878034	MBS 16 X	01	37
9 03 19 223 00 0	4014586878041	MBS 25 F	01	37
9 03 20 223 00 0	4014586878515	IBS 16	01	37
9 08 01 012 00 8	4014586835075	Balancer up to 1.5 kg	01	282
9 08 01 023 00 1	4014586835099	Balancer up to 2.5 kg	01	282
9 08 01 024 00 9	4014586835105	Balancer up to 3 kg	01	283
9 08 01 025 00 3	4014586835136	Balancer up to 5 kg	01	283
9 08 01 026 00 6	4014586835143	Balancer up to 6.5 kg	01	283
9 08 01 027 00 0	4014586835150	Balancer up to 9 kg	01	283
9 08 01 028 00 8	4014586835167	Balancer up to 11 kg	01	283
9 08 01 029 00 2	4014586835174	Balancer up to 14 kg	01	283
9 08 01 030 00 4	4014586835181	Balancer up to 17 kg	01	283
9 08 01 037 00 9	4014586835228	Balancer up to 2.5 kg	01	282
9 08 01 052 00 4	4014586854052	Balancer up to 1.5 kg	01	282
9 08 01 055 00 0	4014586880693	Balancer up to 25 kg	01	284
9 08 01 056 00 0	4014586880709	Balancer up to 32 kg	01	284
9 08 01 057 00 0	4014586880716	Balancer up to 45 kg	01	284
9 08 01 058 00 0	4014586880723	Balancer up to 60 kg	01	284
9 20 29 060 00 0	4014586882956	FEIN Dustex 35 LX	01	193
9 20 30 060 00 0	4014586882994	FEIN Dustex 35 LX AC	01	193
9 20 31 060 00 0	4014586883052	FEIN Dustex 35 MX	01	194
9 20 32 060 00 0	4014586883069	FEIN Dustex 35 MX AC	01	194
9 20 35 060 00 0	4014586891828	FEIN Dustex 25 L set	01	192
9 20 35 223 00 0	4014586891866	FEIN Dustex 25 L	01	192
9 20 36 060 00 0	4014586891903	FEIN Dustex 35 L set	01	192
9 20 36 223 00 0	4014586891941	FEIN Dustex 35 L	01	193
9 28 21 340 12 5	4014586845548	MO82-11KSR 50400 200 Hz 72 V	10	-
9 28 21 340 17 2	4014586845555	MO82-11KSR 50400 200 Hz 135 V	10	-
9 28 21 340 20 4	4014586845562	MO82-11KSR 50400 200 Hz 265 V	10	-
9 28 21 340 22 9	4014586845586	MO83-11KSR 50400 300 Hz 72 V	10	-
9 28 21 340 26 0	4014586845593	MO83-11KSR 50400 300 Hz 200 V	10	112
9 28 24 340 12 7	4014586845678	MO82-30KSR 50400 200 Hz 72 V	10	-
9 28 24 340 17 4	4014586845685	MO82-30KSR 50400 200 Hz 135 V	10	-
9 28 24 340 20 6	4014586845692	MO82-30KSR 50400 200 Hz 265 V	10	-
9 28 24 340 22 1	4014586845708	MO83-30 KSR 50400 300 Hz 72 V	10	-
9 28 24 340 26 2	4014586845715	MO83-30KSR 50400 300 Hz 200 V	10	113
9 28 26 340 12 3	4014586850344	MO82-45KSR 50400 200 Hz 72 V	10	-
9 28 26 340 17 0	4014586845722	MO82-45KSR 50400 200 Hz 135 V	10	-
9 28 26 340 20 2	4014586845739	MO82-45KSR 50400 200 Hz 265 V	10	-

Part number	EAN	Description	PC	Page
9 28 26 340 22 7	4014586850351	MO83-45 KSR 50400 300 Hz 72 V	10	-
9 28 26 340 26 8	4014586845746	MO83-45KSR 50400 300 Hz 200 V	10	113
9 28 28 340 12 1	4014586845753	MO82-20KSR 50400 200 Hz 72 V	10	-
9 28 28 340 17 8	4014586845760	MO82-20KSR 50400 200 Hz 135 V	10	-
9 28 28 340 20 0	4014586845777	MO82-20KSR 50400 200 Hz 265 V	10	-
9 28 28 340 22 5	4014586845784	MO83-20 KSR 50400 300 Hz 72 V	10	-
9 28 28 340 26 6	4014586845791	MO83-20KSR 50400 300 Hz 200 V	10	112
9 90 01 001 00 1	4014586871974	GRIT GXR	13	261
9 90 01 002 00 0	4014586858340	GRIT GIXS	13	269
9 90 01 003 00 0	4014586859064	GRIT GIB	13	268
9 90 01 004 00 0	4014586859071	GRIT GIBE	13	268
9 90 01 007 00 1	4014586878263	GRIT GIR	13	268
9 90 01 009 00 0	4014586859125	GRIT GIXBE	13	269
9 90 01 012 00 0	4014586880488	GRIT GHBD	01	256
9 90 01 012 01 0	4014586886992	GRIT GHBM	01	257
9 90 01 012 02 0	4014586887005	GRIT GHBR	01	257
9 90 01 012 03 0	4014586887548	GRIT GHBML	01	257

Part number	EAN	Description	PC	Page
3 01 09 011 00 7	4014586008844	Die	02	-
3 01 09 106 00 9	4014586009230	Die	02	-
3 01 09 128 01 8	4014586198071	adapter	04	-
3 01 09 141 00 3	4014586224060	Die, No. in pack 1 pcs	02	134
3 01 09 141 02 0	4014586318134	Die, No. in pack 2 pcs	02	134
3 01 09 141 03 0	4014586318141	Die, No. in pack 5 pcs	02	134
3 01 09 154 00 7	4014586246598	Die holder	02	134
3 01 09 169 00 9	4014586265056	Die, No. in pack 1 pcs	02	133
3 01 09 169 03 0	4014586275024	Punches and dies in a set	02	133
3 01 09 169 04 0	4014586318158	Die, No. in pack 2 pcs	02	133
3 01 09 170 00 1	4014586265063	Die, No. in pack 1 pcs	02	133
3 01 09 170 03 0	4014586275031	Punches and dies in a set	02	133
3 01 09 170 04 0	4014586318165	Die, No. in pack 2 pcs	02	133
3 01 09 203 00 0	4014586351230	Adapter wedge	02	-
3 02 16 130 00 4	4014586010427	Bolts	02	-
3 02 17 337 00 2	4014586245225	Centering pin, L 125 mm	02	-
3 02 17 338 00 0	4014586251271	Centering pin, L 85 mm	02	-
3 02 17 359 00 0	4014586341958	Centering pin, L 80 mm	02	162
3 02 17 362 01 0	4014586425184	Centering pin, L 184 mm, Ø 7.98 mm	02	183
3 02 29 216 00 5	4014586012155	Safety guard	02	210
3 02 29 347 01 0	4014586354330	Metal skewers	02	-
3 02 31 003 00 3	4014586012414	Chain clamps	02	-
3 02 31 008 00 0	4014586012421	Chain clamps	02	-
3 02 31 013 02 7	4014586012483	Roller chain	08	-
3 02 31 029 00 2	4014586224183	Roller chain	08	-
3 02 31 034 01 0	4014586422145	Chain piece	08	-
3 02 31 035 01 0	4014586422169	Chain piece	08	-
3 02 31 036 01 0	4014586422176	Chain piece	08	-
3 02 32 044 01 0	4014586232591	Swivel hook	02	284
3 02 32 046 00 8	4014586259604	Suspension Device	06	29
3 02 34 022 00 9	4014586012865	Clamping collar	08	-
3 02 40 239 01 4	4014586232584	Locking device	02	284
3 02 40 247 00 2	4014586253510	Bottle holder	02	-
3 02 40 308 01 0	4014586353111	Vacuum ring set	02	-
3 02 40 395 00 0	4014586444321	Securing pin	02	53
3 02 40 396 00 0	4014586444338	Circlip	02	53
3 02 40 396 01 0	4014586444345	Locking set	02	53
3 05 01 242 00 1	4014586014272	Spacer sleeve	02	-
3 05 01 345 01 0	4014586272993	Coding sleeves, Colour black, No. in pack 10 pcs	06	-
3 05 01 345 02 0	4014586273006	Coding sleeves, Colour Colour mix, No. in pack 7 pcs	06	-
3 05 01 346 01 0	4014586273013	Coding sleeves, Colour grey, No. in pack 10 pcs	06	-
3 05 01 347 01 0	4014586273020	Coding sleeves, Colour green, No. in pack 10 pcs	06	-
3 05 01 348 01 0	4014586273037	Coding sleeves, Colour blue, No. in pack 10 pcs	06	-
3 05 01 349 01 0	4014586273044	Coding sleeves, Colour red, No. in pack 10 pcs	06	-
3 05 01 350 01 0	4014586273051	Coding sleeves, Colour orange, No. in pack 10 pcs	06	-
3 05 01 351 01 0	4014586274898	Coding sleeves, Colour yellow, No. in pack 10 pcs	06	-
3 05 01 352 01 0	4014586317106	Coding sleeves, Colour black, No. in pack 10 pcs	06	58
3 05 01 352 02 0	4014586317113	Coding sleeves, Colour Colour mix, No. in pack 7 pcs	06	58
3 05 01 353 01 0	4014586317120	Coding sleeves, Colour grey, No. in pack 10 pcs	06	58
3 05 01 354 01 0	4014586317137	Coding sleeves, Colour green, No. in pack 10 pcs	06	58
3 05 01 355 01 0	4014586317144	Coding sleeves, Colour blue, No. in pack 10 pcs	06	58
3 05 01 356 01 0	4014586317151	Coding sleeves, Colour red, No. in pack 10 pcs	06	58
3 05 01 357 01 0	4014586317168	Coding sleeves, Colour orange, No. in pack 10 pcs	06	58
3 05 01 358 01 0	4014586317175	Coding sleeves, Colour yellow, No. in pack 10 pcs	06	58
3 05 05 066 01 5	4014586235271	Stop sleeve	02	-
3 05 05 068 01 7	4014586248769	Stop sleeve	02	-
3 05 05 069 01 1	4014586258928	Stop sleeve	02	-
3 05 17 028 00 7	4014586016931	Hose sleeve, Ø 32 mm	02	140
3 05 17 029 00 1	4014586016948	Hose sleeve, Ø 27 mm	02	140
3 06 05 109 00 6	4014586224503	Adapter hose	02	-
3 06 05 110 00 8	4014586224510	Adapter hose	02	-
3 06 05 114 01 1	4014586266848	Adapter for FEIN SuperCut without QuickIN	04	245

Part number	EAN	Description	PC	Page
3 07 06 268 00 6	4014586022260	Spiral cordset	02	-
3 07 07 157 03 5	4014586321035	Spiral cordset	06	284
3 07 28 123 00 7	4014586030104	Male connector	02	114
3 07 28 124 00 5	4014586030111	Male connector	02	114
3 07 28 130 00 0	4014586030173	Sleeve plug	02	114
3 07 28 131 00 9	4014586030180	Sleeve plug	02	114
3 07 28 137 00 5	4014586030241	Wall socket	02	115
3 07 28 138 00 3	4014586030258	Wall socket	02	115
3 07 28 141 00 8	4014586030289	Assembly socket	02	115
3 07 28 432 00 0	4014586410388	EU-GB plug adapter	02	-
3 07 28 452 00 0	4014586424507	EU-GB plug adapter	02	-
3 07 49 065 00 9	4014586031927	Device combination	10	115
3 07 49 067 00 6	4014586031941	Device combination	10	115
3 07 49 068 00 4	4014586031965	Device combination	10	115
3 07 49 069 00 8	4014586031972	Device combination	10	115
3 07 49 070 00 0	4014586031989	Device combination	10	115
3 07 49 073 00 6	4014586032016	Device combination	10	115
3 07 49 086 00 0	4014586032108	Device combination	10	-
3 07 49 099 00 5	4014586032221	Device combination	10	-
3 07 49 100 00 6	4014586326375	Device combination	10	-
3 07 51 144 00 3	4014586032993	Motor protection switch	02	-
3 07 56 017 00 6	4014586033358	Motor protection plug	02	-
3 07 56 084 00 8	4014586264189	Motor protection plug	02	-
3 07 56 085 00 2	4014586264196	Motor protection plug, Model 16 A	02	114
3 07 56 086 00 5	4014586264202	Motor protection plug	02	-
3 07 56 087 00 9	4014586264219	Motor protection plug, Model 16 A	02	114
3 07 56 088 00 7	4014586264226	Motor protection plug, Model 16 A	02	114
3 07 56 089 00 1	4014586264233	Motor protection plug, Model 16 A	02	114
3 07 56 090 00 3	4014586264240	Motor protection plug, Model 16 A	02	114
3 07 56 093 00 9	4014586264271	Motor protection plug, Model 32 A	02	114
3 07 56 094 00 7	4014586264288	Motor protection plug	02	-
3 07 56 095 00 1	4014586264295	Motor protection plug, Model 32 A	02	114
3 07 56 096 00 4	4014586264301	Motor protection plug, Model 32 A	02	114
3 07 56 097 00 8	4014586264318	Motor protection plug, Model 32 A	02	114
3 07 56 098 00 6	4014586264325	Motor protection plug, Model 32 A	02	114
3 07 98 592 77 0	4014586622040	Cable	02	-
3 12 07 103 01 3	4014586044910	Eccentric head	06	207
3 13 08 072 00 0	4014586048123	Plunger blade and fixed blade	02	124
3 13 08 092 00 8	4014586210803	Fixed blade	02	125
3 13 08 096 00 7	4014586210810	Plunger blade, Plate thickness 4.2 mm	02	125
3 13 08 098 00 9	4014586213477	Plunger blade, Plate thickness 2 mm	02	125
3 13 08 110 00 3	4014586229812	Cutting blade, Plate thickness 2 mm	02	121
3 13 08 111 00 2	4014586229829	Blade pin	02	121
3 13 08 113 00 9	4014586229836	Cutting bars	02	121
3 13 08 123 00 8	4014586229867	Cutting blade, Plate thickness 1.3 mm	02	121
3 13 08 136 00 2	4014586229805	Fixed blade, Plate thickness 3.5 mm	02	124
3 13 08 143 00 6	4014586230092	Fixed blade, Plate thickness 2 mm	02	124
3 13 08 146 00 1	4014586232911	Plunger blade, Plate thickness 3.5 mm	02	125
3 13 08 147 00 5	4014586232928	Plunger blade, Plate thickness 2 mm	02	125
3 13 08 150 00 9	4014586239583	Cutting blade, Plate thickness 1.6 mm	02	121
3 13 08 151 00 8	4014586239590	Blade for curves, Plate thickness 1 mm	02	121
3 13 08 152 00 1	4014586239606	Cutting blade, Plate thickness 0.8 mm	02	121
3 13 08 153 01 4	4014586239613	Cutting bars	02	121
3 13 08 153 02 0	4014586239620	Cutting bars	02	121
3 13 09 036 00 4	4014586048512	Punch	02	-
3 13 09 039 00 0	4014586048543	Supporting pin	02	-
3 13 09 040 00 2	4014586048550	Die	02	134
3 13 09 093 00 3	4014586199931	Die	02	134
3 13 09 094 00 1	4014586199948	Die	02	134
3 13 09 097 00 2	4014586199955	Punch	02	134
3 13 09 098 00 0	4014586199962	Punch	02	134
3 13 09 100 01 4	4014586199986	Spacer sleeve	02	-

Part number	EAN	Description	PC	Page
3 13 09 107 00 0	4014586210742	Die	02	135
3 13 09 107 00 0	4014586210742	Die	02	135
3 13 09 108 00 8	4014586210759	Die	02	135
3 13 09 109 00 2	4014586210766	Die	02	135
3 13 09 110 00 4	4014586210773	Punch	02	135
3 13 09 110 01 3	4014586259161	Punches and dies in a set	02	135
3 13 09 114 00 8	4014586210780	Chips bag	02	135
3 13 09 119 00 1	4014586209852	Punch	02	–
3 13 09 121 00 2	4014586209876	Wearing plate	02	134
3 13 09 122 00 5	4014586209883	Die, No. in pack 1 pcs	02	134
3 13 09 122 02 0	4014586318172	Die, No. in pack 2 pcs	02	134
3 13 09 122 03 0	4014586318189	Die, No. in pack 5 pcs	02	134
3 13 09 134 00 6	4014586259185	Punch	02	135
3 13 09 134 01 5	4014586259192	Punches and dies in a set	02	135
3 13 22 169 00 5	4014586053202	Hose sleeve	02	–
3 13 22 757 01 6	4014586261386	Filter bag, Model Dustex II, 25	02	196
3 13 22 765 00 9	4014586261454	Filter cartridge	02	197
3 13 22 767 01 5	4014586261478	Suction hose	02	197
3 13 22 771 00 9	4014586261492	Connecting piece	02	140
3 13 22 772 00 2	4014586261508	Stepped collar	02	197
3 13 22 810 01 0	4014586307718	Filter bag, Model Dustex 40	02	196
3 13 22 811 01 0	4014586307725	Filter bag, Model Dustex 40	02	196
3 13 27 064 00 8	4014586199580	Protective steel jaws	02	144
3 13 27 068 00 7	4014586199627	Straining screw	02	–
3 13 33 090 00 0	4014586368375	Drill chuck	02	–
3 13 33 118 00 0	4014586368382	Drill chuck	02	–
3 13 35 017 01 1	4014586262390	Rotating roller	02	203
3 13 45 012 01 0	4014586366197	Flat-fold filter	02	195
3 13 45 059 01 0	4014586366210	Flat-fold filter	02	195
3 13 45 060 01 0	4014586366227	Flat-fold filter	02	195
3 13 45 061 01 0	4014586366234	Fleece filter bag, Model Dustex 25 L, No. in pack 5 pcs	02	196
3 13 45 062 01 0	4014586366241	Fleece filter bag, Model Dustex 35 L, No. in pack 5 pcs	02	196
3 13 45 063 01 0	4014586366258	Disposal bag, No. in pack 5 pcs	02	196
3 13 45 064 01 0	4014586366265	Permanent filter	02	196
3 13 45 065 01 0	4014586366272	Suction hose, Ø 27 mm, L 4 m	02	195
3 13 45 066 01 0	4014586366289	Suction hose, Ø 35 mm, L 4 m	02	195
3 13 45 067 01 0	4014586366296	Extension hose, Ø 27 mm, L 2.5 m	02	195
3 13 45 068 01 0	4014586366302	Extension hose, Ø 35 mm, L 2.5 m	02	195
3 13 45 069 01 0	4014586366319	Repair set	02	195
3 13 45 070 01 0	4014586366326	Elbow	02	195
3 13 45 071 01 0	4014586366333	Suction tube	02	195
3 13 45 071 02 0	4014586368528	Accessory set	02	196
3 13 45 072 01 0	4014586366340	Floor nozzle	02	195
3 13 45 073 01 0	4014586366357	Combination nozzle	02	195
3 13 45 074 01 0	4014586366364	Crevice nozzle	02	195
3 13 45 075 01 0	4014586366371	Upholstery nozzle	02	195
3 13 45 076 01 0	4014586366388	Suction brush	02	195
3 13 45 077 01 0	4014586366395	Intake brush	02	195
3 13 45 079 01 0	4014586366418	Stepped collar	02	195
3 13 45 119 01 0	4014586370187	Cable holder, No. in pack 5 pcs	02	196
3 13 45 120 01 0	4014586386119	Antistatic suction hose, Ø 35 mm, L 4 m	02	195
3 13 45 121 01 0	4014586392059	Antistatic suction hose, Ø 27 mm, L 4 m	02	195
3 13 45 123 01 0	4014586378596	Antistatic tool collar	02	195
3 13 45 130 01 0	4014586379449	HEPA filter bag, No. in pack 3 pcs	02	196
3 13 45 133 02 0	4014586386126	Accessory set, Ø 40 mm	02	196
3 13 45 138 01 0	4014586387819	Brush strips	02	–
3 13 45 251 01 0	4014586392691	Premium fleece filter bag, Model Dustex 35 L, No. in pack 5 pcs	02	196
3 13 45 263 01 0	4014586394459	Elbow, Ø 35 mm	02	195
3 13 45 267 01 0	4014586400013	Brush strips	02	–
3 13 45 268 01 0	4014586400020	Rubber lip	02	–
3 13 45 270 01 0	4014586400037	Brush strips	02	–
3 13 45 271 01 0	4014586400044	Rubber lip	02	–

Part number	EAN	Description	PC	Page
3 13 45 273 01 0	4014586409955	Premium fleece filter bag, Model Dustex 25 L, No. in pack 5 pcs	02	196
3 13 45 274 01 0	4014586414959	Flat-fold filter	02	-
3 13 45 300 01 0	4014586439341	Antistatic tool collar	02	195
3 13 48 073 01 0	4014586385839	Wheel guard, Ø 115 mm	06	82
3 13 48 134 01 0	4014586436029	Wheel guard, Ø 125 mm	06	82
3 13 48 135 01 0	4014586436180	Safety hood for cutting work, Ø 115 mm	02	82
3 13 50 075 00 0	4014586441320	KX clamping screw, No. in pack 10 pcs	02	149
3 13 50 076 00 0	4014586441337	SX clamping screw, No. in pack 10 pcs	02	148
3 14 14 004 00 3	4014586060026	Hose	08	-
3 14 14 054 00 8	4014586208916	Replacement hose	02	163
3 14 14 055 00 2	4014586227290	Hose	08	-
3 14 14 055 01 1	4014586252421	Hose	08	-
3 14 14 070 01 0	4014586356433	Flex-jointed hose, L 340 mm	02	186
3 14 14 078 01 0	4014586428901	Flex-jointed hose, L 500 mm	02	186
3 14 15 020 00 8	4014586060392	Anti vibration mounts	02	115
3 14 15 081 00 1	4014586207865	Anti vibration mounts	02	115
3 14 20 120 01 0	4014586376677	Protection for AccuTec ASM, Model ASM 14	02	-
3 14 26 030 00 5	4014586061641	Hook and loop fastener, Ø 150 mm	02	207
3 14 26 067 01 6	4014586236797	Anti-slip mat	02	-
3 14 28 102 01 6	4014586195957	Anti-chipping protector, No. in pack 5 pcs	02	140
3 14 28 156 00 0	4014586272047	Plastic cover	02	-
3 18 01 010 01 2	4014586069210	Support	02	-
3 18 10 071 01 5	4014586069739	Wheel guard	02	-
3 18 10 171 00 5	4014586070124	Protective suction hood	02	-
3 18 10 240 01 4	4014586228945	Protect.suction hood	06	206
3 18 10 247 01 9	4014586241906	Contact and swarf protection	02	-
3 18 10 264 01 0	4014586307343	Protect.suction hood	02	206
3 18 10 277 00 0	4014586326238	Wheel guard	02	-
3 18 10 299 00 0	4014586394107	Wheel guard, Ø 115 mm	06	82
3 18 10 300 00 0	4014586394114	Wheel guard, Ø 125 mm	06	204
3 18 10 301 00 0	4014586394121	Wheel guard, Ø 150 mm	06	82
3 18 10 305 00 0	4014586407852	Wheel guard	02	-
3 21 09 061 01 6	4014586074542	Clamping unit	02	-
3 21 19 032 00 2	4014586074689	Side handle	02	-
3 21 19 047 00 4	4014586074801	Handle	02	-
3 21 19 078 02 4	4014586074962	Handle	02	-
3 21 19 107 01 6	4014586222882	Handle	02	-
3 21 19 113 01 6	4014586235264	Handle	02	-
3 21 19 116 01 1	4014586267616	Bail handle	04	245
3 21 19 117 01 5	4014586268125	anti-vibration handle	02	114
3 21 19 118 01 3	4014586268132	anti-vibration handle	02	114
3 21 19 119 01 7	4014586268149	anti-vibration handle	02	-
3 21 19 124 01 0	4014586334783	anti-vibration handle	02	114
3 21 19 127 03 0	4014586351971	Starter awl	02	-
3 21 19 148 02 0	4014586404790	Additional handle	04	238
3 21 19 150 01 0	4014586404523	Handle	02	59
3 21 22 007 01 7	4014586075198	Crank	08	-
3 21 23 002 00 6	4014586270906	Adjustment spanner - torque	02	58
3 21 25 043 00 4	4014586075341	Bow	02	-
3 21 25 050 00 7	4014586075396	Suspension Device	02	29
3 21 26 012 01 0	4014586410210	Tool holder	02	58
3 21 27 003 03 5	4014586075594	Depth stop	02	-
3 21 27 005 00 6	4014586075600	Depth stop	02	29
3 21 27 021 03 6	4014586075761	Stop sleeve	02	-
3 21 27 021 06 1	4014586075792	Stop sleeve	02	-
3 21 27 021 11 3	4014586250724	Stop sleeve	02	-
3 21 27 021 12 9	4014586258669	Stop sleeve	02	-
3 21 27 021 13 5	4014586262406	Stop sleeve	02	-
3 21 27 021 14 1	4014586270531	Depth stop	02	-
3 21 27 043 00 0	4014586075983	Stop sleeve	02	-
3 21 27 057 00 8	4014586208831	Stop sleeve	02	-
3 21 27 065 01 9	4014586266077	Depth stop	02	-

Part number	EAN	Description	PC	Page
3 21 27 069 01 0	4014586351674	Depth stop	04	228
3 21 31 038 02 0	4014586451794	Coolant tank	02	163
3 21 32 020 12 9	4014586076706	Cutting paste	04	120
3 21 32 022 00 7	4014586076713	Pump	02	163
3 21 32 039 00 0	4014586418087	BIOCUT 3000 lubricant, Contents 1 l	08	–
3 21 32 040 00 0	4014586418094	BIOCUT 3000 lubricant, Contents 5 l	08	–
3 21 32 042 00 0	4014586422879	Lubricant with resistance to the cold, Contents 1 l	08	–
3 21 32 043 00 0	4014586422886	Lubricant with resistance to the cold, Contents 5 l	08	–
3 21 33 021 01 0	4014586404745	Device for dust extract	04	238
3 21 73 003 00 3	4014586265568	Work gloves, Size 9 L	04	148
3 21 73 004 00 1	4014586265575	Work gloves, Size 10 XL	04	148
3 21 73 005 00 5	4014586265582	Work gloves, Size 11 XXL	04	148
3 21 74 003 00 0	4014586077215	Protective cage	02	–
3 21 74 006 00 5	4014586199641	Ratchet buckle w/ strap	02	–
3 21 74 007 00 9	4014586214740	Ratchet buckle w/ strap	02	–
3 21 74 008 00 7	4014586241890	Strap, safety	02	–
3 21 74 009 00 1	4014586321813	Wrist strap	08	–
3 21 74 010 00 3	4014586321820	Wrist strap	08	–
3 21 74 011 00 0	4014586319056	Protective cover	04	250
3 21 74 013 01 0	4014586335773	Swarf cup	02	–
3 21 74 014 01 0	4014586376691	AccuTec ASW protective cover, Model ASW 14	02	–
3 21 74 015 01 0	4014586376707	Battery cover	02	–
3 21 74 016 01 0	4014586376714	Battery cover	02	–
3 21 74 019 01 0	4014586404905	Battery cover	02	58
3 21 74 020 01 0	4014586404912	Battery cover	02	58
3 21 74 021 01 0	4014586404929	Plastic cover, Model <60 Nm	02	59
3 21 74 022 01 0	4014586404936	Plastic cover, Model <45 Nm	02	59
3 21 74 023 01 0	4014586414003	Plastic cover, Model <14 Nm	02	59
3 21 74 024 01 0	4014586404943	AccuTec ASW protective cover, Model ASW 18	02	58
3 21 74 025 01 0	4014586415499	Battery cover	02	58
3 21 74 028 01 0	4014586434018	Protection for AccuTec ASM, Model ASM 18	02	58
3 21 74 029 01 0	4014586435268	Battery cover	02	58
3 24 22 346 01 0	4014586431093	Spacer	08	–
3 24 33 027 01 7	4014586210469	Plate	08	–
3 26 23 009 00 6	4014586200699	Reducing rings, Ø 53 / 43 mm	02	39
3 26 23 010 00 8	4014586200422	Reducing rings, Ø 53 / 38 mm	02	39
3 26 23 012 01 9	4014586248776	Reducing rings, Ø 43 / 33 mm	02	39
3 26 23 013 00 4	4014586248783	Reducing rings, Ø 43 / 38 mm	02	39
3 26 23 014 01 0	4014586369853	Reducing rings, Ø 53 / 43 mm	02	39
3 27 14 037 01 3	4014586091938	Bow	02	–
3 27 14 071 01 3	4014586092201	Clamping jaw	02	–
3 27 14 088 00 7	4014586200750	Chipping protector	02	140
3 39 01 031 00 1	4014586110233	Tool case	08	–
3 39 01 096 01 6	4014586242095	Tool case	02	–
3 39 01 114 00 7	4014586266732	Transport box	08	–
3 39 01 118 01 0	4014586285474	Tool case	02	120
3 39 01 118 20 0	4014586302775	Tool case	04	–
3 39 01 118 48 0	4014586317618	Tool case	02	29
3 39 01 119 00 0	4014586285498	Plastic box	02	120
3 39 01 122 01 0	4014586308791	Tool case	02	203
3 39 01 122 06 0	4014586321165	Tool case	02	–
3 39 01 122 12 0	4014586336732	Tool case	02	–
3 39 01 122 19 0	4014586405759	Tool case	02	–
3 39 01 126 02 0	4014586332406	Tool box ass.	02	–
3 39 01 127 02 0	4014586325859	Tool box ass.	02	–
3 39 01 130 05 0	4014586333250	Tool case	02	–
3 39 01 131 03 0	4014586348957	Tool case	02	–
3 39 01 131 08 0	4014586348650	Tool case	02	34
3 39 01 131 92 0	4014586376325	Plastic tool cases	02	–
3 39 01 131 94 0	4014586379630	Tool case	02	33
3 39 01 131 98 0	4014586376332	Carrying case unfilled	04	–
3 39 01 132 03 0	4014586340449	Tool box ass.	02	–

Part number	EAN	Description	PC	Page
3 39 01 133 05 0	4014586351247	Tool case	02	-
3 39 01 134 04 0	4014586340456	Tool box ass.	02	-
3 39 01 140 99 0	4014586356310	Tool case	02	-
3 39 01 141 01 0	4014586365244	Plastic tool cases	02	-
3 39 01 142 14 0	4014586356921	Case	02	163
3 39 01 143 06 0	4014586356938	Case	02	-
3 39 01 146 00 0	4014586380025	Systainer Sys 1	02	-
3 39 01 146 19 0	4014586430836	Tool case	02	-
3 39 01 146 22 0	4014586416946	Systainer Starlock Plus	04	-
3 39 01 147 00 0	4014586380032	Systainer Sys 2	02	-
3 39 01 152 00 0	4014586398396	Plastic tool cases	02	-
3 39 01 152 05 0	4014586407654	Plastic tool cases	04	-
3 39 01 152 39 0	4014586420080	Plastic tool cases	02	-
3 39 01 154 03 0	4014586411903	Plastic tool cases	04	-
3 39 01 154 05 0	4014586403786	Plastic tool cases	04	-
3 39 01 155 02 0	4014586379647	Tool box ass.	02	-
3 39 01 157 32 0	4014586410593	Tool case	02	47
3 39 01 174 06 0	4014586403809	Tool box ass.	02	-
3 39 01 182 02 0	4014586420097	Plastic tool cases	02	-
3 39 01 189 10 0	4014586441672	Tool case	02	-
3 39 01 604 02 0	4014586422893	Case	02	-
3 39 04 542 00 0	4014586380056	Systainer insert for AFSC 18 Q	06	244
3 39 98 140 02 2	4014586622231	Plastic tool cases	02	-
3 39 98 140 08 2	401458662039	Case	02	-
3 39 98 140 13 0	4014586425955	Case	02	163
3 43 00 000 00 1	4014586402796	Contact guard	04	228
3 52 22 927 05 0	4014586392455	Adapter for FEIN oscillator (up to 2004)	04	238
3 52 22 952 01 0	4014586392516	HSS saw blade set, Ø 100 mm, Mount SLP	04	228
3 52 22 952 03 0	4014586392530	E-Cut-Combo, Mount SLP	04	-
3 52 22 952 04 0	4014586392547	Adapter for FEIN SuperCut without QuickIN	04	245
3 52 22 952 05 0	4014586392554	Adapter for FEIN SuperCut with QuickIN	04	245
3 52 22 952 10 0	4014586404721	Set of sanding sheets, Edge length 130 mm	04	234
3 52 22 967 01 0	4014586440378	Best of E-Cut Starlock WOOD & METAL, Mount SL	04	228
3 52 22 967 02 0	4014586440385	Best of Starlock METAL, Mount SL	04	232
3 52 22 967 03 0	4014586440392	Best of E-Cut StarlockPlus WOOD & METAL, Mount SLP	04	228
3 52 22 967 04 0	4014586440408	Best of Starlock SANDING, Mount SL	04	232
3 52 22 967 05 0	4014586440415	Best of E-Cut StarlockMax WOOD & METAL, Mount SLM	04	228
3 52 22 967 06 0	4014586440507	Best of Starlock RENOVATION, Mount SL	04	232
3 52 22 967 07 0	4014586440422	Starlock TILE WORKING combo, Mount SL	04	237
3 52 22 967 08 0	4014586440439	Starlock WOOD E-Cut combo, Mount SL	04	229
3 52 22 967 09 0	4014586440446	Starlock MINI CUT combo, Mount SL	04	229
3 52 22 967 10 0	4014586440453	Starlock WOOD & METAL E-Cut combo, Mount SL	04	228
3 52 22 967 11 0	4014586440460	Starlock RENOVATION combo, Mount SL	04	232
3 52 22 967 12 0	4014586440477	StarlockMax INTERIOR WORK professional set, Mount SLM	04	232
3 52 22 967 13 0	4014586440484	StarlockMax GROUT RENEWAL professional set, Mount SLM	04	237
3 52 22 967 14 0	4014586440491	StarlockMax HEATING/SANITARY professional set, Mount SLM	04	237
3 52 22 967 26 0	4014586444253	Professional marine set, Mount SLP	04	-
3 90 00 000 00 1	4014586280028	Graphite pad, No. in pack 5 pcs	06	274
3 90 00 000 00 2	4014586280035	Hose	06	276
3 90 00 000 00 3	4014586280042	Tube clamps	06	276
3 90 00 000 00 4	4014586280059	Eye protection, No. in pack 3 pcs	06	274
3 90 00 000 00 7	4014586280080	Eye protection GU75/GR/GXR (3 pieces)	06	275
3 90 00 000 05 6	4014586283517	Graphite coating	06	276
3 90 00 000 10 0	4014586294162	Metal filter	06	278
3 90 00 000 18 3	4014586283500	Graphite coating	06	279
3 90 00 000 18 4	4014586283494	Eye protection, No. in pack 3 pcs	06	277
3 90 00 000 19 0	4014586283487	Eye protection, No. in pack 3 pcs	06	279
3 90 00 000 49 6	4014586280325	Guide rail, brass	06	276
3 90 00 000 49 7	4014586280332	Nylon glide support	06	276
3 90 00 000 97 6	4014586286303	Cassette filter	06	278
3 90 00 001 00 2	4014586353739	Brake wheel	06	-
3 90 00 004 76 0	4014586380933	Graphite pad, No. in pack 4 pcs	06	279

Part number	EAN	Description	PC	Page
3 90 00 008 10 6	4014586389837	Stainless steel sanding support	02	258
3 90 00 009 92 3	4014586434919	Stainless steel sanding support	13	278
4 06 11 009 01 9	4014586126760	Set of sealing rings	02	-
4 11 14 001 00 8	4014586128030	Nipple	08	-
4 11 35 007 00 2	4014586128177	Clutch part	08	-
4 11 36 005 00 0	4014586128269	Coupling sleeve	08	-
4 11 36 005 01 9	4014586128276	Coupling sleeve	08	-
4 11 36 006 00 3	4014586128283	Coupling sleeve	08	-
4 11 40 004 00 7	4014586128399	Hose coupling	02	144
4 30 33 087 06 5	4014586225173	Set of clamping screws	04	-
6 01 10 008 01 7	4014586165790	Tool holder Ø 7 mm with external flat	02	-
6 05 03 306 00 8	4014586262772	Bit, 1/4" hexagon head	02	65
6 05 05 015 00 1	4014586258713	Bits 1/4" for hexagon socket screws	02	-
6 05 10 011 00 9	4014586235141	Tool holder 1/4" external hexagon, Ø 15 mm, L 51 mm	02	47
6 05 10 215 00 3	4014586258812	Tool holder 1/4" external hexagon, Ø 10.6 mm, L 45 mm	02	61
6 05 10 222 01 0	4014586404820	Bit holder, Accessory interface QuickIN	02	48
6 20 05 019 01 0	4014586420141	Impact socket with protective cover, Tool Holder 1/4" Outer square, wrench size 7 mm	02	-
6 20 05 020 01 0	4014586420158	Impact socket with protective cover, Tool Holder 1/4" Outer square, wrench size 8 mm	02	-
6 20 05 021 01 0	4014586420165	Impact socket with protective cover, Tool Holder 1/4" Outer square, wrench size 10 mm	02	-
6 20 05 023 01 0	4014586420172	Impact socket with protective cover, Tool Holder 1/4" Outer square, wrench size 13 mm	02	-
6 20 05 024 01 0	4014586420189	Impact socket with protective cover, Tool Holder 1/4" Outer square, wrench size 16 mm	02	-
6 21 05 017 01 0	4014586420196	Impact socket with protective cover, Tool Holder 3/8" Outer square, wrench size 8 mm	02	-
6 21 05 018 01 0	4014586420202	Impact socket with protective cover, Tool Holder 3/8" Outer square, wrench size 10 mm	02	-
6 21 05 019 01 0	4014586420219	Impact socket with protective cover, Tool Holder 3/8" Outer square, wrench size 13 mm	02	-
6 21 05 020 01 0	4014586420226	Impact socket with protective cover, Tool Holder 3/8" Outer square, wrench size 16 mm	02	-
6 22 05 023 01 0	4014586420233	Impact socket with protective cover, Tool Holder 1/2" Outer square, wrench size 16 mm	02	-
6 22 05 024 01 0	4014586420240	Impact socket with protective cover, Tool Holder 1/2" Outer square, wrench size 18 mm	02	-
6 22 05 025 01 0	4014586420257	Impact socket with protective cover, Tool Holder 1/2" Outer square, wrench size 21 mm	02	-
6 22 05 026 01 0	4014586420264	Impact socket with protective cover, Tool Holder 1/2" Outer square, wrench size 24 mm	02	-
6 22 19 002 07 9	4014586168012	Socket for stay bolts	02	-
6 22 19 002 09 1	4014586168036	Socket for stay bolts	02	-
6 22 19 002 10 6	4014586168043	Socket for stay bolts	02	-
6 22 19 002 14 3	4014586168074	Socket for stay bolts	02	-
6 24 05 323 01 0	4014586442006	Impact socket, wrench size 24 mm	02	53
6 24 05 323 02 0	4014586442075	Set of impact sockets	02	53
6 24 05 324 01 0	4014586442013	Impact socket, wrench size 27 mm	02	53
6 24 05 325 01 0	4014586442020	Impact socket, wrench size 30 mm	02	53
6 24 05 326 01 0	4014586442037	Impact socket, wrench size 32 mm	02	53
6 24 05 327 01 0	4014586442044	Impact socket, wrench size 34 mm	02	53
6 24 05 328 01 0	4014586442051	Impact socket, wrench size 36 mm	02	53
6 24 05 329 01 0	4014586442068	Impact socket, wrench size 41 mm	02	53
6 24 15 002 01 0	4014586440118	Reduction adapter	02	53
6 27 12 109 03 4	4014586169637	Bit, 1/4" hexagon head, Size 2, L 25 mm	02	65
6 29 01 002 00 4	4014586172071	Jaw spanner SW8	02	-
6 29 01 003 00 8	4014586172088	Jaw spanner SW9	02	-
6 29 01 007 00 7	4014586172125	Jaw spanner SW13	02	-
6 29 03 002 00 9	4014586172255	Jaw spanner SW17	02	29
6 29 03 010 00 6	4014586172309	Single head wrench	08	-
6 29 03 011 00 5	4014586172316	Jaw spanner SW17	02	-
6 29 04 003 00 0	4014586172347	Jaw spanner SW19	02	-
6 29 06 009 00 7	4014586172415	Socket spanner SW 8	02	-
6 29 06 014 00 0	4014586419534	Pipe socket wrench	08	-
6 29 07 004 00 5	4014586172446	Allen key SW6	02	-
6 29 07 006 00 2	4014586172453	Allen key SW8	02	-
6 29 07 010 00 0	4014586172477	Allen key SW4	02	-
6 29 07 011 00 9	4014586172484	Allen key SW5	02	-
6 29 07 013 00 6	4014586172491	Allen key SW3	02	-
6 29 07 015 00 8	4014586172514	Allen key SW2.5	02	-
6 29 07 017 00 5	4014586172521	Allen key, WAF 4.5	02	-
6 29 07 023 00 5	4014586172545	Allen key SW4	02	-
6 29 07 029 00 6	4014586172590	Allen key SW2	02	-
6 29 07 030 00 8	4014586172606	Allen key SW8	02	-

Part number	EAN	Description	PC	Page
6 29 07 037 00 3	4014586249728	Allen key	02	-
6 29 08 013 00 3	4014586172675	Sickle spanner	02	-
6 29 08 014 00 0	4014586413709	Sickle spanner	07	59
6 29 08 015 00 0	4014586419541	Sickle spanner	02	-
6 29 10 022 00 2	4014586172736	Bidirectional nut spanner	02	-
6 29 10 023 00 6	4014586172743	Bi-directional nut spanner	02	-
6 29 10 031 00 8	4014586172811	Bi-directional nut spanner	04	-
6 29 11 010 00 0	4014586220772	Ring spanner 17 x 19	08	-
6 29 12 001 00 4	4014586266107	Screwdriver	02	-
6 29 12 002 01 0	4014586441375	Socket head wrench, WAF 4	02	-
6 29 12 003 01 0	4014586441382	Socket head wrench, WAF 5	02	-
6 29 12 004 01 0	4014586441399	T15 torx wrench	02	-
6 29 13 004 00 0	4014586172859	Retaining pin	02	-
6 29 13 020 00 4	4014586172927	Retaining pin	02	-
6 29 14 002 00 5	4014586172941	Chuck key	02	-
6 29 14 004 00 7	4014586172958	Chuck key	02	-
6 29 14 005 00 1	4014586172965	Chuck key	02	-
6 29 14 011 00 1	4014586173016	Chuck key	02	-
6 31 06 016 01 0	4014586271767	Extension	02	183
6 31 06 017 01 0	4014586335063	Extension	02	-
6 31 06 022 98 0	4014586720180	Extension	02	183
6 31 10 019 02 0	4014586416069	Tapping drill set for through holes, Thread M 6	02	186
6 31 10 019 03 0	4014586416076	Tapping drill for through holes with adapter with 3/4" Weldon fitting, Thread M 6	02	186
6 31 10 020 02 0	4014586416083	Tapping drill set for through holes, Thread M 8	02	186
6 31 10 020 03 0	4014586416090	Tapping drill for through holes with adapter with 3/4" Weldon fitting, Thread M 8	02	186
6 31 10 021 02 0	4014586416106	Tapping drill set for through holes, Thread M 10	02	186
6 31 10 021 03 0	4014586416113	Tapping drill for through holes with adapter with 3/4" Weldon fitting, Thread M 10	02	186
6 31 10 022 02 0	4014586416120	Tapping drill set for through holes, Thread M 12	02	186
6 31 10 022 03 0	4014586416137	Tapping drill for through holes with adapter with 3/4" Weldon fitting, Thread M 12	02	186
6 31 11 009 01 0	4014586326597	HSS spiral drill with QuickIN fitting, Bore Ø 10 mm	02	184
6 31 11 010 01 0	4014586326603	HSS spiral drill with QuickIN fitting, Bore Ø 10.2 mm	02	184
6 31 11 011 01 0	4014586326610	HSS spiral drill with QuickIN fitting, Bore Ø 11 mm	02	184
6 31 11 012 01 0	4014586326627	HSS spiral drill with QuickIN fitting, Bore Ø 12 mm	02	184
6 31 11 013 01 0	4014586326634	HSS spiral drill with QuickIN fitting, Bore Ø 13 mm	02	184
6 31 11 014 01 0	4014586326641	HSS spiral drill with QuickIN fitting, Bore Ø 14 mm	02	184
6 31 11 015 01 0	4014586326658	HSS spiral drill with QuickIN fitting, Bore Ø 15 mm	02	184
6 31 11 016 01 0	4014586326665	HSS spiral drill with QuickIN fitting, Bore Ø 15.5 mm	02	184
6 31 11 018 01 0	4014586409085	HSS twist drill with 3/4" Weldon fitting, Bore Ø 6 mm	02	163
6 31 11 018 02 0	4014586416144	HSS twist drill set with 3/4" Weldon fitting	02	163
6 31 11 019 01 0	4014586409092	HSS twist drill with 3/4" Weldon fitting, Bore Ø 7 mm	02	163
6 31 11 020 01 0	4014586409108	HSS twist drill with 3/4" Weldon fitting, Bore Ø 8 mm	02	163
6 31 11 021 01 0	4014586409115	HSS twist drill with 3/4" Weldon fitting, Bore Ø 9 mm	02	163
6 31 11 022 01 0	4014586409122	HSS twist drill with 3/4" Weldon fitting, Bore Ø 10 mm	02	163
6 31 11 023 01 0	4014586409139	HSS twist drill with 3/4" Weldon fitting, Bore Ø 11 mm	02	163
6 31 11 024 01 0	4014586409146	HSS twist drill with 3/4" Weldon fitting, Bore Ø 12 mm	02	163
6 31 11 025 01 0	4014586409153	HSS twist drill with 3/4" Weldon fitting, Bore Ø 13 mm	02	163
6 31 11 026 01 0	4014586409160	HSS twist drill with 3/4" Weldon fitting, Bore Ø 14 mm	02	163
6 31 11 027 01 0	4014586409177	HSS twist drill with 3/4" Weldon fitting, Bore Ø 15 mm	02	163
6 31 11 028 01 0	4014586409184	HSS twist drill with 3/4" Weldon fitting, Bore Ø 16 mm	02	163
6 31 11 034 01 0	4014586409658	HSS twist drill with 3/4" Weldon fitting, Bore Ø 6.8 mm	02	163
6 31 11 035 01 0	4014586409665	HSS twist drill with 3/4" Weldon fitting, Bore Ø 8.5 mm	02	163
6 31 11 036 01 0	4014586415109	HSS twist drill with 3/4" Weldon fitting, Bore Ø 5 mm	02	163
6 31 11 037 01 0	4014586415116	HSS twist drill with 3/4" Weldon fitting, Bore Ø 10.2 mm	02	163
6 31 11 038 01 0	4014586415727	HSS 90° countersink bit, Ø 16.5 mm	02	163
6 31 11 038 02 0	4014586416168	HSS 90° countersink bit with adapter with 3/4" Weldon fitting, Ø 16.5 mm	02	163
6 31 14 038 01 0	4014586331027	Centring drill bit, No. in pack 1 pcs	02	49
6 31 14 038 02 0	4014586332796	Centring drill bit, No. in pack 5 pcs	02	49
6 31 27 001 01 5	4014586176130	TCT Ultra 50 core bit with FEIN thread M 18 x 6 P 1.5, Bore Ø 18 mm, Cutting depth 50 mm	20	177
6 31 27 002 01 8	4014586176147	TCT Ultra 50 core bit with FEIN thread M 18 x 6 P 1.5, Bore Ø 20 mm, Cutting depth 50 mm	20	177
6 31 27 003 01 2	4014586176154	TCT Ultra 50 core bit with FEIN thread M 18 x 6 P 1.5, Bore Ø 22 mm, Cutting depth 50 mm	20	177
6 31 27 004 01 0	4014586176161	TCT Ultra 50 core bit with FEIN thread M 18 x 6 P 1.5, Bore Ø 25 mm, Cutting depth 50 mm	20	177
6 31 27 005 01 4	4014586176178	TCT Ultra 50 core bit with FEIN thread M 18 x 6 P 1.5, Bore Ø 26 mm, Cutting depth 50 mm	20	177

Part number	EAN	Description	PC	Page
6 31 33 499 05 1	4014586615981	HSS Nova 25 core bit with QuickIN holder, Bore Ø 50 mm, Cutting depth 25 mm	20	179
6 31 33 499 05 2	4014586616018	HSS Nova 50 core bit with QuickIN holder, Bore Ø 50 mm, Cutting depth 50 mm	20	180
6 31 33 500 06 7	4014586615592	HSS Dura 25 core bit with QuickIN holder, Bore Ø 50 mm, Cutting depth 25 mm	20	181
6 31 33 500 06 8	4014586615653	HSS Dura 50 core bit with QuickIN holder, Bore Ø 50 mm, Cutting depth 50 mm	20	182
6 31 33 999 01 0	4014586375571	Best of core bits QuickIN	20	179
6 31 34 120 05 1	4014586611457	HSS Nova 25 core bit with 3/4" Weldon holder, Bore Ø 12 mm, Cutting depth 25 mm	20	161
6 31 34 120 05 2	4014586611488	HSS Nova 50 core bit with 3/4" Weldon holder, Bore Ø 12 mm, Cutting depth 50 mm	20	161
6 31 34 120 07 5	4014586611464	HSS Dura 25 core bit with 3/4" Weldon holder, Bore Ø 12 mm, Cutting depth 25 mm	20	162
6 31 34 120 07 6	4014586611495	HSS Dura 50 core bit with 3/4" Weldon holder, Bore Ø 12 mm, Cutting depth 50 mm	20	162
6 31 34 120 30 1	4014586635064	HSS SPECIAL 25 core bit with 3/4" Weldon fitting, Bore Ø 12 mm, Cutting depth 25 mm	20	162
6 31 34 130 05 1	4014586611792	HSS Nova 25 core bit with 3/4" Weldon holder, Bore Ø 13 mm, Cutting depth 25 mm	20	161
6 31 34 130 05 2	4014586611839	HSS Nova 50 core bit with 3/4" Weldon holder, Bore Ø 13 mm, Cutting depth 50 mm	20	161
6 31 34 130 07 5	4014586611808	HSS Dura 25 core bit with 3/4" Weldon holder, Bore Ø 13 mm, Cutting depth 25 mm	20	162
6 31 34 130 07 6	4014586611846	HSS Dura 50 core bit with 3/4" Weldon holder, Bore Ø 13 mm, Cutting depth 50 mm	20	162
6 31 34 130 30 1	4014586635071	HSS SPECIAL 25 core bit with 3/4" Weldon fitting, Bore Ø 13 mm, Cutting depth 25 mm	20	162
6 31 34 140 05 1	4014586611877	HSS Nova 25 core bit with 3/4" Weldon holder, Bore Ø 14 mm, Cutting depth 25 mm	20	161
6 31 34 140 05 2	4014586611914	HSS Nova 50 core bit with 3/4" Weldon holder, Bore Ø 14 mm, Cutting depth 50 mm	20	161
6 31 34 140 07 5	4014586611884	HSS Dura 25 core bit with 3/4" Weldon holder, Bore Ø 14 mm, Cutting depth 25 mm	20	162
6 31 34 140 07 6	4014586611921	HSS Dura 50 core bit with 3/4" Weldon holder, Bore Ø 14 mm, Cutting depth 50 mm	20	162
6 31 34 140 30 1	4014586635088	HSS SPECIAL 25 core bit with 3/4" Weldon fitting, Bore Ø 14 mm, Cutting depth 25 mm	20	162
6 31 34 143 30 1	4014586635354	HSS SPECIAL 25 core bit with 3/4" Weldon fitting, Bore Ø 14.3 mm, Cutting depth 25 mm	20	162
6 31 34 150 05 1	4014586612164	HSS Nova 25 core bit with 3/4" Weldon holder, Bore Ø 15 mm, Cutting depth 25 mm	20	161
6 31 34 150 05 2	4014586612201	HSS Nova 50 core bit with 3/4" Weldon holder, Bore Ø 15 mm, Cutting depth 50 mm	20	161
6 31 34 150 07 5	4014586612171	HSS Dura 25 core bit with 3/4" Weldon holder, Bore Ø 15 mm, Cutting depth 25 mm	20	162
6 31 34 150 07 6	4014586612218	HSS Dura 50 core bit with 3/4" Weldon holder, Bore Ø 15 mm, Cutting depth 50 mm	20	162
6 31 34 150 30 1	4014586635095	HSS SPECIAL 25 core bit with 3/4" Weldon fitting, Bore Ø 15 mm, Cutting depth 25 mm	20	162
6 31 34 160 05 1	4014586612249	HSS Nova 25 core bit with 3/4" Weldon holder, Bore Ø 16 mm, Cutting depth 25 mm	20	161
6 31 34 160 05 2	4014586612287	HSS Nova 50 core bit with 3/4" Weldon holder, Bore Ø 16 mm, Cutting depth 50 mm	20	161
6 31 34 160 07 5	4014586612256	HSS Dura 25 core bit with 3/4" Weldon holder, Bore Ø 16 mm, Cutting depth 25 mm	20	162
6 31 34 160 07 6	4014586612294	HSS Dura 50 core bit with 3/4" Weldon holder, Bore Ø 16 mm, Cutting depth 50 mm	20	162
6 31 34 160 30 1	4014586635101	HSS SPECIAL 25 core bit with 3/4" Weldon fitting, Bore Ø 16 mm, Cutting depth 25 mm	20	162
6 31 34 170 05 1	4014586612461	HSS Nova 25 core bit with 3/4" Weldon holder, Bore Ø 17 mm, Cutting depth 25 mm	20	161
6 31 34 170 05 2	4014586612508	HSS Nova 50 core bit with 3/4" Weldon holder, Bore Ø 17 mm, Cutting depth 50 mm	20	161
6 31 34 170 07 5	4014586612478	HSS Dura 25 core bit with 3/4" Weldon holder, Bore Ø 17 mm, Cutting depth 25 mm	20	162
6 31 34 170 07 6	4014586612515	HSS Dura 50 core bit with 3/4" Weldon holder, Bore Ø 17 mm, Cutting depth 50 mm	20	162
6 31 34 170 30 1	4014586635118	HSS SPECIAL 25 core bit with 3/4" Weldon fitting, Bore Ø 17 mm, Cutting depth 25 mm	20	162
6 31 34 180 05 1	4014586612546	HSS Nova 25 core bit with 3/4" Weldon holder, Bore Ø 18 mm, Cutting depth 25 mm	20	161
6 31 34 180 05 2	4014586612584	HSS Nova 50 core bit with 3/4" Weldon holder, Bore Ø 18 mm, Cutting depth 50 mm	20	161
6 31 34 180 07 5	4014586612553	HSS Dura 25 core bit with 3/4" Weldon holder, Bore Ø 18 mm, Cutting depth 25 mm	20	162
6 31 34 180 07 6	4014586612591	HSS Dura 50 core bit with 3/4" Weldon holder, Bore Ø 18 mm, Cutting depth 50 mm	20	162
6 31 34 180 30 1	4014586635125	HSS SPECIAL 25 core bit with 3/4" Weldon fitting, Bore Ø 18 mm, Cutting depth 25 mm	20	162
6 31 34 190 05 1	4014586612690	HSS Nova 25 core bit with 3/4" Weldon holder, Bore Ø 19 mm, Cutting depth 25 mm	20	161
6 31 34 190 05 2	4014586612737	HSS Nova 50 core bit with 3/4" Weldon holder, Bore Ø 19 mm, Cutting depth 50 mm	20	161
6 31 34 190 05 3	4014586612775	HSS Nova 75 core bit with 3/4" Weldon holder, Bore Ø 19 mm, Cutting depth 75 mm	20	181
6 31 34 190 07 5	4014586612706	HSS Dura 25 core bit with 3/4" Weldon holder, Bore Ø 19 mm, Cutting depth 25 mm	20	162
6 31 34 190 07 6	4014586612744	HSS Dura 50 core bit with 3/4" Weldon holder, Bore Ø 19 mm, Cutting depth 50 mm	20	162
6 31 34 200 05 1	4014586612843	HSS Nova 25 core bit with 3/4" Weldon holder, Bore Ø 20 mm, Cutting depth 25 mm	20	161
6 31 34 200 05 2	4014586612881	HSS Nova 50 core bit with 3/4" Weldon holder, Bore Ø 20 mm, Cutting depth 50 mm	20	161
6 31 34 200 05 3	4014586612928	HSS Nova 75 core bit with 3/4" Weldon holder, Bore Ø 20 mm, Cutting depth 75 mm	20	181
6 31 34 200 07 5	4014586612850	HSS Dura 25 core bit with 3/4" Weldon holder, Bore Ø 20 mm, Cutting depth 25 mm	20	162
6 31 34 200 07 6	4014586612898	HSS Dura 50 core bit with 3/4" Weldon holder, Bore Ø 20 mm, Cutting depth 50 mm	20	162
6 31 34 200 30 1	4014586635132	HSS SPECIAL 25 core bit with 3/4" Weldon fitting, Bore Ø 20 mm, Cutting depth 25 mm	20	162
6 31 34 210 05 1	4014586613109	HSS Nova 25 core bit with 3/4" Weldon holder, Bore Ø 21 mm, Cutting depth 25 mm	20	161
6 31 34 210 05 2	4014586613147	HSS Nova 50 core bit with 3/4" Weldon holder, Bore Ø 21 mm, Cutting depth 50 mm	20	161
6 31 34 210 05 3	4014586613185	HSS Nova 75 core bit with 3/4" Weldon holder, Bore Ø 21 mm, Cutting depth 75 mm	20	181
6 31 34 210 07 5	4014586613116	HSS Dura 25 core bit with 3/4" Weldon holder, Bore Ø 21 mm, Cutting depth 25 mm	20	162
6 31 34 210 07 6	4014586613154	HSS Dura 50 core bit with 3/4" Weldon holder, Bore Ø 21 mm, Cutting depth 50 mm	20	162
6 31 34 220 05 1	4014586613192	HSS Nova 25 core bit with 3/4" Weldon holder, Bore Ø 22 mm, Cutting depth 25 mm	20	161
6 31 34 220 05 2	4014586613239	HSS Nova 50 core bit with 3/4" Weldon holder, Bore Ø 22 mm, Cutting depth 50 mm	20	161
6 31 34 220 05 3	4014586613277	HSS Nova 75 core bit with 3/4" Weldon holder, Bore Ø 22 mm, Cutting depth 75 mm	20	181
6 31 34 220 07 5	4014586613208	HSS Dura 25 core bit with 3/4" Weldon holder, Bore Ø 22 mm, Cutting depth 25 mm	20	162
6 31 34 220 07 6	4014586613246	HSS Dura 50 core bit with 3/4" Weldon holder, Bore Ø 22 mm, Cutting depth 50 mm	20	162

Part number	EAN	Description	PC	Page
6 31 34 490 05 1	4014586615820	HSS Nova 25 core bit with 3/4" Weldon holder, Bore Ø 49 mm, Cutting depth 25 mm	20	161
6 31 34 490 05 2	4014586615868	HSS Nova 50 core bit with 3/4" Weldon holder, Bore Ø 49 mm, Cutting depth 50 mm	20	162
6 31 34 490 07 5	4014586615837	HSS Dura 25 core bit with 3/4" Weldon holder, Bore Ø 49 mm, Cutting depth 25 mm	20	162
6 31 34 490 07 6	4014586615875	HSS Dura 50 core bit with 3/4" Weldon holder, Bore Ø 49 mm, Cutting depth 50 mm	20	162
6 31 34 500 05 1	4014586615967	HSS Nova 25 core bit with 3/4" Weldon holder, Bore Ø 50 mm, Cutting depth 25 mm	20	161
6 31 34 500 05 2	4014586615998	HSS Nova 50 core bit with 3/4" Weldon holder, Bore Ø 50 mm, Cutting depth 50 mm	20	162
6 31 34 500 05 3	4014586616025	HSS Nova 75 core bit with 3/4" Weldon holder, Bore Ø 50 mm, Cutting depth 75 mm	20	181
6 31 34 500 07 5	4014586615974	HSS Dura 25 core bit with 3/4" Weldon holder, Bore Ø 50 mm, Cutting depth 25 mm	20	162
6 31 34 500 07 6	4014586616001	HSS Dura 50 core bit with 3/4" Weldon holder, Bore Ø 50 mm, Cutting depth 50 mm	20	162
6 31 34 510 05 1	4014586616032	HSS Nova 25 core bit with 3/4" Weldon holder, Bore Ø 51 mm, Cutting depth 25 mm	20	180
6 31 34 510 05 2	4014586616056	HSS Nova 50 core bit with 3/4" Weldon holder, Bore Ø 51 mm, Cutting depth 50 mm	20	181
6 31 34 510 07 5	4014586616049	HSS Dura 25 core bit with 3/4" Weldon holder, Bore Ø 51 mm, Cutting depth 25 mm	20	182
6 31 34 510 07 6	4014586616063	HSS Dura 50 core bit with 3/4" Weldon holder, Bore Ø 51 mm, Cutting depth 50 mm	20	182
6 31 34 520 05 1	4014586616070	HSS Nova 25 core bit with 3/4" Weldon holder, Bore Ø 52 mm, Cutting depth 25 mm	20	180
6 31 34 520 05 2	4014586616094	HSS Nova 50 core bit with 3/4" Weldon holder, Bore Ø 52 mm, Cutting depth 50 mm	20	181
6 31 34 520 07 5	4014586616087	HSS Dura 25 core bit with 3/4" Weldon holder, Bore Ø 52 mm, Cutting depth 25 mm	20	182
6 31 34 520 07 6	4014586616100	HSS Dura 50 core bit with 3/4" Weldon holder, Bore Ø 52 mm, Cutting depth 50 mm	20	182
6 31 34 530 05 1	4014586616117	HSS Nova 25 core bit with 3/4" Weldon holder, Bore Ø 53 mm, Cutting depth 25 mm	20	180
6 31 34 530 05 2	4014586616131	HSS Nova 50 core bit with 3/4" Weldon holder, Bore Ø 53 mm, Cutting depth 50 mm	20	181
6 31 34 530 07 5	4014586616124	HSS Dura 25 core bit with 3/4" Weldon holder, Bore Ø 53 mm, Cutting depth 25 mm	20	182
6 31 34 530 07 6	4014586616148	HSS Dura 50 core bit with 3/4" Weldon holder, Bore Ø 53 mm, Cutting depth 50 mm	20	182
6 31 34 540 05 1	4014586616155	HSS Nova 25 core bit with 3/4" Weldon holder, Bore Ø 54 mm, Cutting depth 25 mm	20	180
6 31 34 540 05 2	4014586616179	HSS Nova 50 core bit with 3/4" Weldon holder, Bore Ø 54 mm, Cutting depth 50 mm	20	181
6 31 34 540 07 5	4014586616162	HSS Dura 25 core bit with 3/4" Weldon holder, Bore Ø 54 mm, Cutting depth 25 mm	20	182
6 31 34 540 07 6	4014586616186	HSS Dura 50 core bit with 3/4" Weldon holder, Bore Ø 54 mm, Cutting depth 50 mm	20	182
6 31 34 550 05 1	4014586616193	HSS Nova 25 core bit with 3/4" Weldon holder, Bore Ø 55 mm, Cutting depth 25 mm	20	180
6 31 34 550 05 2	4014586616216	HSS Nova 50 core bit with 3/4" Weldon holder, Bore Ø 55 mm, Cutting depth 50 mm	20	181
6 31 34 550 05 3	4014586616230	HSS Nova 75 core bit with 3/4" Weldon holder, Bore Ø 55 mm, Cutting depth 75 mm	20	-
6 31 34 550 07 5	4014586616209	HSS Dura 25 core bit with 3/4" Weldon holder, Bore Ø 55 mm, Cutting depth 25 mm	20	182
6 31 34 550 07 6	4014586616223	HSS Dura 50 core bit with 3/4" Weldon holder, Bore Ø 55 mm, Cutting depth 50 mm	20	182
6 31 34 555 05 1	4014586613284	HSS Nova 1 in core bit with Weldon holder	20	-
6 31 34 555 05 3	4014586613321	HSS Nova 3 in core bit with Weldon holder	20	-
6 31 34 560 05 1	4014586616247	HSS Nova 25 core bit with 3/4" Weldon holder, Bore Ø 56 mm, Cutting depth 25 mm	20	180
6 31 34 560 05 2	4014586616261	HSS Nova 50 core bit with 3/4" Weldon holder, Bore Ø 56 mm, Cutting depth 50 mm	20	181
6 31 34 560 07 5	4014586616254	HSS Dura 25 core bit with 3/4" Weldon holder, Bore Ø 56 mm, Cutting depth 25 mm	20	182
6 31 34 560 07 6	4014586616278	HSS Dura 50 core bit with 3/4" Weldon holder, Bore Ø 56 mm, Cutting depth 50 mm	20	182
6 31 34 570 05 1	4014586616285	HSS Nova 25 core bit with 3/4" Weldon holder, Bore Ø 57 mm, Cutting depth 25 mm	20	180
6 31 34 570 05 2	4014586616308	HSS Nova 50 core bit with 3/4" Weldon holder, Bore Ø 57 mm, Cutting depth 50 mm	20	181
6 31 34 570 07 5	4014586616292	HSS Dura 25 core bit with 3/4" Weldon holder, Bore Ø 57 mm, Cutting depth 25 mm	20	182
6 31 34 570 07 6	4014586616315	HSS Dura 50 core bit with 3/4" Weldon holder, Bore Ø 57 mm, Cutting depth 50 mm	20	182
6 31 34 580 05 1	4014586616322	HSS Nova 25 core bit with 3/4" Weldon holder, Bore Ø 58 mm, Cutting depth 25 mm	20	180
6 31 34 580 05 2	4014586616346	HSS Nova 50 core bit with 3/4" Weldon holder, Bore Ø 58 mm, Cutting depth 50 mm	20	181
6 31 34 580 07 5	4014586616339	HSS Dura 25 core bit with 3/4" Weldon holder, Bore Ø 58 mm, Cutting depth 25 mm	20	182
6 31 34 580 07 6	4014586616353	HSS Dura 50 core bit with 3/4" Weldon holder, Bore Ø 58 mm, Cutting depth 50 mm	20	182
6 31 34 590 05 1	4014586616360	HSS Nova 25 core bit with 3/4" Weldon holder, Bore Ø 59 mm, Cutting depth 25 mm	20	180
6 31 34 590 05 2	4014586616384	HSS Nova 50 core bit with 3/4" Weldon holder, Bore Ø 59 mm, Cutting depth 50 mm	20	181
6 31 34 590 07 5	4014586616377	HSS Dura 25 core bit with 3/4" Weldon holder, Bore Ø 59 mm, Cutting depth 25 mm	20	182
6 31 34 590 07 6	4014586616391	HSS Dura 50 core bit with 3/4" Weldon holder, Bore Ø 59 mm, Cutting depth 50 mm	20	182
6 31 34 600 05 1	4014586616407	HSS Nova 25 core bit with 3/4" Weldon holder, Bore Ø 60 mm, Cutting depth 25 mm	20	180
6 31 34 600 05 2	4014586616421	HSS Nova 50 core bit with 3/4" Weldon holder, Bore Ø 60 mm, Cutting depth 50 mm	20	181
6 31 34 600 05 3	4014586616445	HSS Nova 75 core bit with 3/4" Weldon holder, Bore Ø 60 mm, Cutting depth 75 mm	20	181
6 31 34 600 07 5	4014586616414	HSS Dura 25 core bit with 3/4" Weldon holder, Bore Ø 60 mm, Cutting depth 25 mm	20	182
6 31 34 600 07 6	4014586616438	HSS Dura 50 core bit with 3/4" Weldon holder, Bore Ø 60 mm, Cutting depth 50 mm	20	182
6 31 34 998 30 0	4014586629926	Centering pin, L 82 mm, Ø 6.35 mm	02	162
6 31 34 998 30 5	4014586629933	Centering pin, L 80 mm, Ø 4.75 mm	02	-
6 31 34 998 31 0	4014586629940	Centering pin, L 100 mm, Ø 6.35 mm	02	162
6 31 34 998 33 0	4014586629971	Centering pin, L 125 mm, Ø 6.35 mm	02	183
6 31 34 998 33 5	4014586633084	Centering pin, L 135 mm, Ø 6.35 mm	02	183
6 31 34 998 36 0	4014586630007	Centering pin, L 200 mm, Ø 6.35 mm	02	-
6 31 34 999 06 1	4014586375588	Best of core bits 3/4" Weldon	20	160
6 31 34 999 06 2	4014586375595	Best of core bits 3/4" Weldon	20	160
6 31 34 999 06 3	4014586375601	Best of core bits 3/4" Weldon	20	160

Part number	EAN	Description	PC	Page
6 31 34 999 06 4	4014586375618	Best of core bits 3/4" Weldon	20	160
6 32 02 003 01 4	4014586176925	Key-type drill chucks	02	-
6 32 02 028 01 9	4014586176963	Key-type drill chucks	02	-
6 32 02 030 01 5	4014586176987	Key-type drill chucks, Chuck opening 1.5-13 mm	02	30
6 32 02 037 01 0	4014586177007	Key-type drill chucks, Chuck opening 3-16 mm	02	30
6 32 02 043 01 0	4014586177038	Key-type drill chucks, Chuck opening 0.5-8 mm	02	33
6 32 02 044 01 8	4014586223674	Key-type drill chucks, Chuck opening 0.8-10 mm	02	33
6 32 03 034 01 0	4014586177052	Key-type drill chucks, Chuck opening 1-10 mm	02	29
6 32 03 041 01 4	4014586177083	Key-type drill chucks, Chuck opening 1.5-13 mm	02	29
6 32 03 050 01 4	4014586204291	Key-type drill chucks	02	-
6 32 04 020 00 5	4014586177250	Quick-action chucks	02	-
6 32 04 025 00 3	4014586177281	Quick-action chucks, Chuck opening 3-16 mm	02	30
6 32 04 028 00 8	4014586177311	Quick-action chucks	02	-
6 32 04 030 00 4	4014586177335	Quick-action chucks	02	-
6 32 04 032 00 6	4014586177359	Quick-action chucks, Chuck opening 1-13 mm	02	30
6 32 05 032 01 6	4014586256795	Quick-action chuck	02	-
6 32 05 033 01 0	4014586266084	Quick-action chucks, Chuck opening 1-13 mm	02	29
6 32 05 035 01 0	4014586321721	Quick-action chucks, Chuck opening 1.5-13 mm	02	29
6 32 05 036 01 0	4014586321738	Quick-action chucks, Chuck opening 0.5 - 10 mm	02	29
6 32 05 037 02 0	4014586365091	Drill chuck	02	-
6 32 05 038 01 0	4014586368870	Quick-action chucks, Chuck opening 3-16 mm	02	29
6 32 06 018 00 5	4014586177410	Jaw chuck	02	-
6 32 06 018 01 0	4014586336459	Jaw chuck	02	-
6 32 06 019 00 9	4014586177427	Jaw chuck	02	35
6 32 06 040 00 9	4014586177441	Floating jaw chuck	02	-
6 32 06 041 00 8	4014586177458	Floating jaw chuck	02	35
6 32 06 061 02 1	4014586177465	Floating collet chuck	02	-
6 32 06 063 01 2	4014586177489	Collet chuck	02	35
6 32 06 064 00 1	4014586177496	Collets, Ø 3.5 mm, Square 2.7 mm	02	35
6 32 06 065 00 5	4014586177502	Collets, Ø 4.5 mm, Square 3.4 mm	02	35
6 32 06 066 00 8	4014586177519	Collets, Ø 6 mm, Square 4.9 mm	02	35
6 32 06 067 01 1	4014586177526	Collet chuck	02	-
6 32 06 067 02 0	4014586336749	Collet chuck	02	-
6 32 06 070 00 6	4014586177533	Collets, Ø 7 mm, Square 5.5 mm	02	35
6 32 06 075 00 4	4014586177588	Collets, Ø 9 mm, Square 7 mm	02	35
6 32 06 076 02 2	4014586177595	Floating collet chuck	02	35
6 32 06 077 00 1	4014586177601	Collets, Ø 2.8 mm, Square 2.1 mm	02	35
6 32 06 078 00 9	4014586177618	Collets, Ø 8 mm, Square 6.2 mm	02	35
6 32 06 079 00 3	4014586177625	Collets, Ø 10 mm, Square 8 mm	02	35
6 32 06 095 01 1	4014586224350	Tapping Inserts, Thread M 6, Ø 6 mm, Square 4.9 mm	02	185
6 32 06 096 01 4	4014586224367	Tapping Inserts, Thread M 10, Ø 7 mm, Square 5.5 mm	02	185
6 32 06 097 01 8	4014586224374	Tapping Inserts, Thread M 12, Ø 9 mm, Square 7 mm	02	185
6 32 06 098 01 6	4014586224381	Tapping Inserts, Thread M 14, Ø 11 mm, Square 9 mm	02	185
6 32 06 099 01 0	4014586224398	Tapping Inserts, Thread M 16, Ø 12 mm, Square 9 mm	02	185
6 32 06 100 01 1	4014586224404	Tapping Inserts, Thread M 18, Ø 14 mm, Square 11 mm	02	185
6 32 06 101 01 0	4014586224411	Tapping Inserts, Thread M 20, Ø 16 mm, Square 12 mm	02	185
6 32 06 102 01 3	4014586229294	Tapping Inserts, Thread M 8, Ø 6 mm, Square 4.9 mm	02	185
6 32 06 103 01 7	4014586229300	Tapping Inserts, Thread M 10, Ø 7 mm, Square 5.5 mm	02	185
6 32 06 104 01 5	4014586229317	Tapping Inserts, Thread M 12, Ø 9 mm, Square 7 mm	02	185
6 32 06 105 01 9	4014586229324	Tapping Inserts, Thread M 14, Ø 11 mm, Square 9 mm	02	185
6 32 06 106 01 2	4014586229331	Tapping Inserts, Thread M 16, Ø 12 mm, Square 9 mm	02	185
6 32 06 107 01 6	4014586229348	Tapping Inserts, Thread M 18, Ø 14 mm, Square 11 mm	02	185
6 32 06 108 01 4	4014586229355	Tapping Inserts, Thread M 20, Ø 16 mm, Square 12 mm	02	185
6 32 06 117 01 5	4014586253459	Tapping Inserts, Thread M 6, Ø 4.5 mm, Square 3.4 mm	02	185
6 32 06 118 01 3	4014586253466	Tapping Inserts, Thread M 6, Ø 6 mm, Square 4.9 mm	02	185
6 32 06 119 01 0	4014586298689	Tapping Inserts, Thread M22/M24, Ø 18 mm, Square 14.5 mm	02	185
6 32 06 120 01 0	4014586298696	Tapping Inserts, Thread M 27, Ø 20 mm, Square 16 mm	02	185
6 32 06 121 01 0	4014586298702	Tapping Inserts, Thread M 30, Ø 22 mm, Square 18 mm	02	185
6 32 06 122 01 0	4014586298719	Tapping Inserts, Thread M22/M24, Ø 18 mm, Square 14.5 mm	02	185
6 32 06 123 01 0	4014586298726	Tapping Inserts, Thread M 27, Ø 20 mm, Square 16 mm	02	185
6 32 06 124 01 0	4014586298733	Tapping Inserts, Thread M 30, Ø 22 mm, Square 18 mm	02	185
6 32 06 125 01 0	4014586298740	Interchangeable reducing insert (size 3 to size 2)	02	185

Part number	EAN	Description	PC	Page
6 32 06 138 01 0	4014586354446	Tapping Inserts, Thread M 8, Ø 8 mm, Square 6.2 mm	02	185
6 32 06 139 01 0	4014586354453	Tapping Inserts, Thread M 10, Ø 10 mm, Square 8 mm	02	185
6 32 06 140 01 0	4014586354460	Tapping Inserts, Thread M 8, Ø 8 mm, Square 6.2 mm	02	185
6 32 06 141 01 0	4014586354477	Tapping Inserts, Thread M 10, Ø 10 mm, Square 8 mm	02	185
6 32 06 146 01 0	4014586633435	Adapter with 3/4" Weldon fitting, Ø 6 mm, Square 4.9 mm	02	185
6 32 06 147 01 0	4014586633442	Adapter with 3/4" Weldon fitting, Ø 7 mm, Square 5.5 mm	02	185
6 32 06 148 01 0	4014586633459	Adapter with 3/4" Weldon fitting	02	163
6 32 06 149 01 0	4014586634562	Adapter with 3/4" Weldon fitting, Ø 9 mm, Square 7 mm	02	186
6 32 06 155 01 0	4014586425450	Tapping Inserts, Thread M 33, Ø 25 mm, Square 20 mm	02	185
6 32 06 156 01 0	4014586425467	Tapping Inserts, Thread M 36, Ø 28 mm, Square 22 mm	02	185
6 32 06 157 01 0	4014586425474	Tapping Inserts, Thread M 33, Ø 25 mm, Square 20 mm	02	185
6 32 06 158 01 0	4014586425481	Tapping Inserts, Thread M 36, Ø 28 mm, Square 22 mm	02	185
6 32 07 059 00 6	4014586177786	Collets, Ø 6 mm	02	-
6 32 07 069 00 5	4014586177793	Collets, Ø 8 mm	02	-
6 32 07 087 00 1	4014586177809	Collets, Ø 3 mm	02	-
6 32 07 088 00 9	4014586177816	Collets, Ø 1/4"	02	-
6 32 07 097 00 0	4014586177861	Collets, Ø 3 mm	02	-
6 32 07 103 00 9	4014586177922	Collets, Ø 6 mm	02	-
6 32 07 128 00 0	4014586375922	Collets, Ø 6 mm	02	99
6 32 07 129 00 0	4014586375939	Collets, Ø 8 mm	02	99
6 32 07 130 00 0	4014586375946	Collets, Ø 3 mm	02	99
6 32 07 131 00 0	4014586375953	Collets, Ø 1/4"	02	99
6 32 07 132 00 0	4014586375960	Collets Inox, Ø 3 mm	02	99
6 32 07 133 00 0	4014586375977	Collets Inox, Ø 6 mm	02	99
6 32 07 134 00 0	4014586375984	Collets Inox, Ø 8 mm	02	99
6 32 07 135 00 0	4014586375991	Collets Inox, Ø 1/4"	02	99
6 32 08 001 02 0	4014586368153	Drill chuck	02	-
6 32 08 002 01 0	4014586392080	Drill chuck, Accessory interface QuickIN	02	47
6 32 08 005 01 0	4014586404837	Drill chuck, Accessory interface QuickIN	02	47
6 33 01 006 00 5	4014586178103	Morse taper arbors	02	-
6 33 01 008 00 7	4014586178110	Morse taper arbors	02	-
6 33 01 012 00 5	4014586178141	Morse taper arbors, Mount MT 3/B 16	02	30
6 33 01 014 00 7	4014586178165	Morse taper arbors, Mount MT 3/B 22	02	30
6 33 01 016 00 4	4014586178172	Morse taper arbors, Mount MT 4/B 22	02	183
6 33 01 021 00 1	4014586223704	Morse taper arbors	02	-
6 33 02 002 00 0	4014586178189	Reducing sleeves	02	-
6 33 02 003 00 4	4014586178196	Reducing sleeves	02	30
6 33 02 004 00 2	4014586178202	Reducing sleeves, Mount MT 4/MT 3	02	183
6 33 04 003 00 2	4014586178226	Enlargement tapers	02	-
6 33 04 005 00 0	4014586312996	Enlargement tapers, Mount MT 3/MT 3	02	184
6 33 05 003 00 3	4014586178257	Drift keys, Mount MT 1/MT 2, Length 140 mm	02	30
6 33 05 004 00 1	4014586178264	Drift keys, Mount MT 3/MT 4, Length 190 mm	02	30
6 33 05 006 00 8	4014586178288	Splitter wedge	02	144
6 33 05 009 01 3	4014586230627	Drifts, Mount B 12, Length 125 mm	02	35
6 33 05 010 01 5	4014586230634	Drifts	02	-
6 33 05 013 00 2	4014586178318	Wedge	08	-
6 34 02 027 00 0	4014586199672	Ratchet with square drive	02	-
6 35 02 022 00 6	4014586178417	Circular saw blades, form 1, Width 4 mm, Teeth 50, Ø 160 mm	08	-
6 35 02 037 00 8	4014586178448	Circular saw blades, form 1, Width 4 mm, Teeth 60, Ø 180 mm	08	-
6 35 02 041 00 1	4014586178455	Circular saw blades, form 1, Width 5 mm, Teeth 70, Ø 220 mm	08	-
6 35 02 053 00 7	4014586178479	Circular saw blades, form 1, Width 4 mm, Teeth 64, Ø 200 mm	08	-
6 35 02 061 00 9	4014586178493	Circular saw blades, form 3, Width 4 mm, Teeth 44, Ø 180 mm	08	-
6 35 02 080 00 8	4014586178585	Circular saw blades, form 3, Width 4 mm, Teeth 40, Ø 160 mm	08	-
6 35 02 084 00 2	4014586178608	Circular saw blades, form 3, Width 4 mm, Teeth 50, Ø 200 mm	08	-
6 35 02 097 21 0	4014586389431	HSS saw blade, Ø 85 mm, No. in pack 1 pcs, Mount SL	04	228
6 35 02 097 22 0	4014586389448	HSS saw blade, Ø 85 mm, No. in pack 2 pcs, Mount SL	04	228
6 35 02 097 23 0	4014586389455	HSS saw blade, Ø 85 mm, No. in pack 5 pcs, Mount SL	04	228
6 35 02 102 01 6	4014586178783	Saw blades, Ø 63 mm, No. in pack 2 pcs	04	242
6 35 02 102 07 0	4014586291703	Saw blades, Ø 63 mm, No. in pack 5 pcs	04	242
6 35 02 103 01 0	4014586178806	Saw blades, Ø 80 mm, No. in pack 2 pcs	04	242
6 35 02 103 05 0	4014586291710	Saw blades, Ø 80 mm, No. in pack 5 pcs	04	242
6 35 02 106 21 0	4014586389462	HSS saw blade, Ø 85 mm, No. in pack 1 pcs, Mount SL	04	228

Part number	EAN	Description	PC	Page
6 35 02 106 22 0	4014586389479	HSS saw blade, Ø 85 mm, No. in pack 2 pcs, Mount SL	04	228
6 35 02 106 23 0	4014586389486	HSS saw blade, Ø 85 mm, No. in pack 5 pcs, Mount SL	04	228
6 35 02 113 21 0	4014586390222	Saw blade, Ø 85 mm, Mount SL	04	228
6 35 02 114 21 0	4014586390239	Diamond-coated saw blade, Ø 75 mm, No. in pack 1 pcs, Mount SL	04	236
6 35 02 114 23 0	4014586390246	Diamond-coated saw blade, Ø 75 mm, No. in pack 5 pcs, Mount SL	04	236
6 35 02 115 01 1	4014586231914	Diamond-coated saw blade, Ø 80 mm, No. in pack 1 pcs	04	244
6 35 02 115 03 0	4014586315058	Diamond-coated saw blade, Ø 80 mm, No. in pack 5 pcs	04	244
6 35 02 116 01 4	4014586231921	Diamond-coated saw blade, Ø 80 mm, No. in pack 1 pcs	04	244
6 35 02 116 02 0	4014586315065	Diamond-coated saw blade, Ø 80 mm, No. in pack 5 pcs	04	244
6 35 02 118 21 0	4014586389493	Carbide saw blade, Ø 75 mm, No. in pack 1 pcs, Mount SL	04	235
6 35 02 118 23 0	4014586389509	Carbide saw blade, Ø 75 mm, No. in pack 5 pcs, Mount SL	04	235
6 35 02 119 01 0	4014586232348	E-Cut precision saw blades, Width 35 mm, No. in pack 1 pcs	04	242
6 35 02 119 03 2	4014586258829	E-Cut precision saw blades, Width 35 mm, No. in pack 25 pcs	04	242
6 35 02 119 04 8	4014586264561	E-Cut precision saw blades, Width 35 mm, No. in pack 5 pcs	04	242
6 35 02 119 07 0	4014586291772	E-Cut precision saw blades, Width 35 mm, No. in pack 100 pcs	04	-
6 35 02 122 01 4	4014586232379	E-Cut precision saw blades, Width 65 mm, No. in pack 1 pcs	04	243
6 35 02 122 03 6	4014586258850	E-Cut precision saw blades, Width 65 mm, No. in pack 25 pcs	04	243
6 35 02 122 04 2	4014586264592	E-Cut precision saw blades, Width 65 mm, No. in pack 5 pcs	04	243
6 35 02 122 07 0	4014586291802	E-Cut precision saw blades, Width 65 mm, No. in pack 100 pcs	04	-
6 35 02 123 01 8	4014586232386	E-Cut standard saw blades, Width 32 mm, No. in pack 1 pcs	04	242
6 35 02 123 03 0	4014586250793	E-Cut standard saw blades, Width 32 mm, No. in pack 25 pcs	04	242
6 35 02 123 04 6	4014586264608	E-Cut standard saw blades, Width 32 mm, No. in pack 5 pcs	04	242
6 35 02 123 07 0	4014586291819	E-Cut standard saw blades, Width 32 mm, No. in pack 100 pcs	04	-
6 35 02 124 01 6	4014586232393	E-Cut standard saw blades, Width 42 mm, No. in pack 1 pcs	04	242
6 35 02 124 03 8	4014586250809	E-Cut standard saw blades, Width 42 mm, No. in pack 25 pcs	04	242
6 35 02 124 04 4	4014586264615	E-Cut standard saw blades, Width 42 mm, No. in pack 5 pcs	04	242
6 35 02 124 07 0	4014586291826	E-Cut standard saw blades, Width 42 mm, No. in pack 100 pcs	04	-
6 35 02 125 21 0	4014586389516	Carbide saw blade, Ø 75 mm, No. in pack 1 pcs, Mount SL	04	236
6 35 02 125 23 0	4014586389523	Carbide saw blade, Ø 75 mm, No. in pack 5 pcs, Mount SL	04	236
6 35 02 126 21 0	4014586386157	E-Cut precision saw blade, Length 50 mm, Width 35 mm, No. in pack 1 pcs, Mount SL	04	230
6 35 02 126 22 0	4014586386164	E-Cut precision saw blade, Length 50 mm, Width 35 mm, No. in pack 3 pcs, Mount SL	04	230
6 35 02 126 23 0	4014586386171	E-Cut precision saw blade, Length 50 mm, Width 35 mm, No. in pack 5 pcs, Mount SL	04	230
6 35 02 126 24 0	4014586386188	E-Cut precision saw blade, Length 50 mm, Width 35 mm, No. in pack 10 pcs, Mount SL	04	230
6 35 02 126 25 0	4014586390260	E-Cut precision saw blade, Length 50 mm, Width 35 mm, No. in pack 50 pcs, Mount SL	04	230
6 35 02 127 21 0	4014586386232	E-Cut precision saw blade, Length 50 mm, Width 65 mm, No. in pack 1 pcs, Mount SLP	04	231
6 35 02 127 22 0	4014586386249	E-Cut precision saw blade, Length 50 mm, Width 65 mm, No. in pack 3 pcs, Mount SLP	04	231
6 35 02 127 23 0	4014586386256	E-Cut precision saw blade, Length 50 mm, Width 65 mm, No. in pack 5 pcs, Mount SLP	04	231
6 35 02 127 24 0	4014586386263	E-Cut precision saw blade, Length 50 mm, Width 65 mm, No. in pack 10 pcs, Mount SLP	04	231
6 35 02 127 25 0	4014586390291	E-Cut precision saw blade, Length 50 mm, Width 65 mm, No. in pack 50 pcs, Mount SLP	04	231
6 35 02 129 01 9	4014586248400	MiniCut HSS saw blade	04	-
6 35 02 130 01 1	4014586248417	MiniCut HSS saw blade	04	-
6 35 02 133 21 0	4014586386317	E-Cut standard saw blade, Length 50 mm, Width 35 mm, No. in pack 1 pcs, Mount SL	04	229
6 35 02 133 22 0	4014586386324	E-Cut standard saw blade, Length 50 mm, Width 35 mm, No. in pack 3 pcs, Mount SL	04	229
6 35 02 133 23 0	4014586386331	E-Cut standard saw blade, Length 50 mm, Width 35 mm, No. in pack 5 pcs, Mount SL	04	229
6 35 02 133 24 0	4014586386348	E-Cut standard saw blade, Length 50 mm, Width 35 mm, No. in pack 10 pcs, Mount SL	04	229
6 35 02 133 25 0	4014586390321	E-Cut standard saw blade, Length 50 mm, Width 35 mm, No. in pack 50 pcs, Mount SL	04	229
6 35 02 134 21 0	4014586386393	E-Cut standard saw blade, Length 50 mm, Width 65 mm, No. in pack 1 pcs, Mount SLP	04	230
6 35 02 134 22 0	4014586386409	E-Cut standard saw blade, Length 50 mm, Width 65 mm, No. in pack 3 pcs, Mount SLP	04	230
6 35 02 134 23 0	4014586386416	E-Cut standard saw blade, Length 50 mm, Width 65 mm, No. in pack 5 pcs, Mount SLP	04	230
6 35 02 134 24 0	4014586386423	E-Cut standard saw blade, Length 50 mm, Width 65 mm, No. in pack 10 pcs, Mount SLP	04	230
6 35 02 134 25 0	4014586390352	E-Cut standard saw blade, Length 50 mm, Width 65 mm, No. in pack 50 pcs, Mount SLP	04	230
6 35 02 135 01 9	4014586248486	E-Cut standard saw blades, Width 35 mm, No. in pack 1 pcs	04	242
6 35 02 135 02 5	4014586258867	E-Cut standard saw blades, Width 35 mm, No. in pack 25 pcs	04	242
6 35 02 135 03 1	4014586264622	E-Cut standard saw blades, Width 35 mm, No. in pack 5 pcs	04	242
6 35 02 135 07 0	4014586291833	E-Cut standard saw blades, Width 35 mm, No. in pack 100 pcs	04	-
6 35 02 136 01 2	4014586248493	E-Cut standard saw blades, Width 65 mm, No. in pack 1 pcs	04	242
6 35 02 136 02 8	4014586258874	E-Cut standard saw blades, Width 65 mm, No. in pack 25 pcs	04	242
6 35 02 136 03 4	4014586264639	E-Cut standard saw blades, Width 65 mm, No. in pack 5 pcs	04	242
6 35 02 136 07 0	4014586291840	E-Cut standard saw blades, Width 65 mm, No. in pack 100 pcs	04	-
6 35 02 146 01 1	4014586259437	Diamond wheel	02	-
6 35 02 147 01 5	4014586262321	E-Cut universal saw blades, Width 28 mm, No. in pack 1 pcs	04	243
6 35 02 147 02 1	4014586264646	E-Cut universal saw blades, Width 28 mm, No. in pack 5 pcs	04	243

Part number	EAN	Description	PC	Page
6 35 02 147 03 7	4014586264721	E-Cut universal saw blades, Width 28 mm, No. in pack 25 pcs	04	243
6 35 02 147 07 0	4014586291857	E-Cut universal saw blades, Width 28 mm, No. in pack 100 pcs	04	–
6 35 02 147 12 0	4014586369655	Best of E-Cut accessory set	04	242
6 35 02 148 01 3	4014586262338	E-Cut universal saw blades, Width 44 mm, No. in pack 1 pcs	04	243
6 35 02 148 02 9	4014586264653	E-Cut universal saw blades, Width 44 mm, No. in pack 5 pcs	04	243
6 35 02 148 03 5	4014586264738	E-Cut universal saw blades, Width 44 mm, No. in pack 25 pcs	04	243
6 35 02 148 07 0	4014586291864	E-Cut universal saw blades, Width 44 mm, No. in pack 100 pcs	04	–
6 35 02 151 21 0	4014586386461	E-Cut universal saw blade, Length 60 mm, Width 28 mm, No. in pack 1 pcs, Mount SLP	04	231
6 35 02 151 22 0	4014586386478	E-Cut universal saw blade, Length 60 mm, Width 28 mm, No. in pack 3 pcs, Mount SLP	04	231
6 35 02 151 23 0	4014586386485	E-Cut universal saw blade, Length 60 mm, Width 28 mm, No. in pack 5 pcs, Mount SLP	04	231
6 35 02 151 24 0	4014586386492	E-Cut universal saw blade, Length 60 mm, Width 28 mm, No. in pack 10 pcs, Mount SLP	04	231
6 35 02 151 25 0	4014586390390	E-Cut universal saw blade, Length 60 mm, Width 28 mm, No. in pack 50 pcs, Mount SLP	04	231
6 35 02 152 21 0	4014586386539	E-Cut universal saw blade, Length 60 mm, Width 44 mm, No. in pack 1 pcs, Mount SLP	04	231
6 35 02 152 22 0	4014586386546	E-Cut universal saw blade, Length 60 mm, Width 44 mm, No. in pack 3 pcs, Mount SLP	04	231
6 35 02 152 23 0	4014586386553	E-Cut universal saw blade, Length 60 mm, Width 44 mm, No. in pack 5 pcs, Mount SLP	04	231
6 35 02 152 24 0	4014586386560	E-Cut universal saw blade, Length 60 mm, Width 44 mm, No. in pack 10 pcs, Mount SLP	04	231
6 35 02 152 25 0	4014586390437	E-Cut universal saw blade, Length 60 mm, Width 44 mm, No. in pack 50 pcs, Mount SLP	04	231
6 35 02 155 01 0	4014586291956	Carbide saw blade, Ø 80 mm, No. in pack 1 pcs	04	243
6 35 02 156 01 0	4014586291963	Carbide saw blade, Ø 80 mm, No. in pack 1 pcs	04	243
6 35 02 157 21 0	4014586386614	E-Cut fine saw blade, Length 50 mm, Width 30 mm, No. in pack 1 pcs, Mount SL	04	231
6 35 02 157 22 0	4014586386621	E-Cut fine saw blade, Length 50 mm, Width 30 mm, No. in pack 3 pcs, Mount SL	04	231
6 35 02 157 23 0	4014586386638	E-Cut fine saw blade, Length 50 mm, Width 30 mm, No. in pack 5 pcs, Mount SL	04	231
6 35 02 157 24 0	4014586386645	E-Cut fine saw blade, Length 50 mm, Width 30 mm, No. in pack 10 pcs, Mount SL	04	231
6 35 02 157 25 0	4014586390451	E-Cut fine saw blade, Length 50 mm, Width 30 mm, No. in pack 50 pcs, Mount SL	04	231
6 35 02 160 21 0	4014586386690	E-Cut long-life saw blade, Length 50 mm, Width 35 mm, No. in pack 1 pcs, Mount SL	04	229
6 35 02 160 22 0	4014586386706	E-Cut long-life saw blade, Length 50 mm, Width 35 mm, No. in pack 3 pcs, Mount SL	04	229
6 35 02 160 23 0	4014586386713	E-Cut long-life saw blade, Length 50 mm, Width 35 mm, No. in pack 5 pcs, Mount SL	04	229
6 35 02 160 24 0	4014586386720	E-Cut long-life saw blade, Length 50 mm, Width 35 mm, No. in pack 10 pcs, Mount SL	04	229
6 35 02 160 25 0	4014586390482	E-Cut long-life saw blade, Length 50 mm, Width 35 mm, No. in pack 50 pcs, Mount SL	04	229
6 35 02 161 21 0	4014586386775	E-Cut long-life saw blade, Length 50 mm, Width 65 mm, No. in pack 1 pcs, Mount SLP	04	229
6 35 02 161 22 0	4014586386782	E-Cut long-life saw blade, Length 50 mm, Width 65 mm, No. in pack 3 pcs, Mount SLP	04	229
6 35 02 161 23 0	4014586386799	E-Cut long-life saw blade, Length 50 mm, Width 65 mm, No. in pack 5 pcs, Mount SLP	04	229
6 35 02 161 24 0	4014586386805	E-Cut long-life saw blade, Length 50 mm, Width 65 mm, No. in pack 10 pcs, Mount SLP	04	229
6 35 02 161 25 0	4014586390512	E-Cut long-life saw blade, Length 50 mm, Width 65 mm, No. in pack 50 pcs, Mount SLP	04	229
6 35 02 162 01 0	4014586336008	E-Cut long-life saw blades, Width 32 mm, No. in pack 1 pcs	04	242
6 35 02 162 02 0	4014586336015	E-Cut long-life saw blades, Width 32 mm, No. in pack 5 pcs	04	242
6 35 02 162 03 0	4014586336022	E-Cut long-life saw blades, Width 32 mm, No. in pack 25 pcs	04	242
6 35 02 162 04 0	4014586341545	E-Cut long-life saw blades, Width 32 mm, No. in pack 100 pcs	04	–
6 35 02 163 01 0	4014586336039	E-Cut long-life saw blades, Width 42 mm, No. in pack 1 pcs	04	242
6 35 02 163 02 0	4014586336046	E-Cut long-life saw blades, Width 42 mm, No. in pack 5 pcs	04	242
6 35 02 163 03 0	4014586336053	E-Cut long-life saw blades, Width 42 mm, No. in pack 25 pcs	04	242
6 35 02 163 04 0	4014586341552	E-Cut long-life saw blades, Width 42 mm, No. in pack 100 pcs	04	–
6 35 02 164 01 0	4014586336060	E-Cut long-life saw blades, Width 35 mm, No. in pack 1 pcs	04	242
6 35 02 164 02 0	4014586336077	E-Cut long-life saw blades, Width 35 mm, No. in pack 5 pcs	04	242
6 35 02 164 03 0	4014586336084	E-Cut long-life saw blades, Width 35 mm, No. in pack 25 pcs	04	242
6 35 02 164 04 0	4014586341569	E-Cut long-life saw blades, Width 35 mm, No. in pack 100 pcs	04	–
6 35 02 165 01 0	4014586336091	E-Cut long-life saw blades, Width 65 mm, No. in pack 1 pcs	04	242
6 35 02 165 02 0	4014586336107	E-Cut long-life saw blades, Width 65 mm, No. in pack 5 pcs	04	242
6 35 02 165 03 0	4014586336114	E-Cut long-life saw blades, Width 65 mm, No. in pack 25 pcs	04	242
6 35 02 165 04 0	4014586341576	E-Cut long-life saw blades, Width 65 mm, No. in pack 100 pcs	04	–
6 35 02 166 21 0	4014586390536	Diamond-coated saw blade, Ø 90 mm, No. in pack 1 pcs, Mount SL	04	236
6 35 02 166 23 0	4014586390543	Diamond-coated saw blade, Ø 90 mm, No. in pack 5 pcs, Mount SL	04	236
6 35 02 167 01 0	4014586342023	Diamond-coated saw blade, Ø 105 mm, No. in pack 1 pcs	04	–
6 35 02 168 01 0	4014586342047	Diamond-coated saw blade, Ø 105 mm, No. in pack 1 pcs	04	–
6 35 02 168 02 0	4014586342054	Diamond-coated saw blade, Ø 105 mm, No. in pack 5 pcs	04	–
6 35 02 169 21 0	4014586390550	Carbide saw blade, Ø 90 mm, No. in pack 1 pcs, Mount SLP	04	235
6 35 02 169 23 0	4014586390567	Carbide saw blade, Ø 90 mm, No. in pack 5 pcs, Mount SLP	04	235
6 35 02 170 21 0	4014586390574	Carbide saw blade, Ø 90 mm, No. in pack 1 pcs, Mount SLP	04	236
6 35 02 170 23 0	4014586390581	Carbide saw blade, Ø 90 mm, No. in pack 5 pcs, Mount SLP	04	236
6 35 02 172 01 0	4014586347691	Carbide saw blade, Ø 105 mm, No. in pack 1 pcs	04	–
6 35 02 172 02 0	4014586347707	Carbide saw blade, Ø 105 mm, No. in pack 5 pcs	04	–
6 35 02 173 01 0	4014586347714	Carbide saw blade, Ø 105 mm, No. in pack 1 pcs	04	–

Part number	EAN	Description	PC	Page
6 35 02 174 21 0	4014586389530	HSS saw blade, Ø 85 mm, No. in pack 1 pcs, Mount SL	04	228
6 35 02 174 23 0	4014586389547	HSS saw blade, Ø 85 mm, No. in pack 5 pcs, Mount SL	04	228
6 35 02 175 21 0	4014586389554	HSS saw blade, Ø 100 mm, No. in pack 1 pcs, Mount SLP	04	228
6 35 02 175 23 0	4014586389561	HSS saw blade, Ø 100 mm, No. in pack 5 pcs, Mount SLP	04	228
6 35 02 176 21 0	4014586389578	HSS saw blade, Ø 100 mm, No. in pack 1 pcs, Mount SLP	04	228
6 35 02 177 01 0	4014586379494	Saw blades, Ø 85 mm, No. in pack 1 pcs	04	242
6 35 02 177 05 0	4014586379500	Saw blades, Ø 85 mm, No. in pack 5 pcs	04	242
6 35 02 178 01 0	4014586379517	Saw blades, Ø 100 mm, No. in pack 1 pcs	04	242
6 35 02 178 05 0	4014586379524	Saw blades, Ø 100 mm, No. in pack 5 pcs	04	242
6 35 02 179 01 0	4014586379272	HSS saw blade wood, Width 100 mm, No. in pack 1 pcs	04	243
6 35 02 179 02 0	4014586379289	HSS saw blade wood, Width 100 mm, No. in pack 1 pcs	04	243
6 35 02 181 00 0	4014586354606	Circular saw blade	08	-
6 35 02 183 21 0	4014586386850	E-Cut long-life saw blade, Length 34 mm, Width 20 mm, No. in pack 1 pcs, Mount SL	04	229
6 35 02 183 22 0	4014586386867	E-Cut long-life saw blade, Length 34 mm, Width 20 mm, No. in pack 3 pcs, Mount SL	04	229
6 35 02 183 23 0	4014586386874	E-Cut long-life saw blade, Length 34 mm, Width 20 mm, No. in pack 5 pcs, Mount SL	04	229
6 35 02 183 24 0	4014586386881	E-Cut long-life saw blade, Length 34 mm, Width 20 mm, No. in pack 10 pcs, Mount SL	04	229
6 35 02 183 25 0	4014586390604	E-Cut long-life saw blade, Length 34 mm, Width 20 mm, No. in pack 50 pcs, Mount SL	04	229
6 35 02 184 21 0	4014586386935	E-Cut long-life saw blade, Length 30 mm, Width 10 mm, No. in pack 1 pcs, Mount SL	04	229
6 35 02 184 22 0	4014586386942	E-Cut long-life saw blade, Length 30 mm, Width 10 mm, No. in pack 3 pcs, Mount SL	04	229
6 35 02 184 23 0	4014586386959	E-Cut long-life saw blade, Length 30 mm, Width 10 mm, No. in pack 5 pcs, Mount SL	04	229
6 35 02 184 24 0	4014586386966	E-Cut long-life saw blade, Length 30 mm, Width 10 mm, No. in pack 10 pcs, Mount SL	04	229
6 35 02 184 25 0	4014586390635	E-Cut long-life saw blade, Length 30 mm, Width 10 mm, No. in pack 50 pcs, Mount SL	04	229
6 35 02 185 03 0	4014586369747	E-Cut long-life saw blades, Width 20 mm, No. in pack 25 pcs	04	-
6 35 02 187 21 0	4014586390659	Carbide saw blade, Ø 90 mm, Mount SLP	04	232
6 35 02 188 21 0	4014586390666	Diamond-coated saw blade, Ø 90 mm, Mount SLP	04	232
6 35 02 189 01 0	4014586377537	Carbide saw blade with open teeth, Ø 105 mm, Cutting width 1.2 mm	04	243
6 35 02 190 01 0	4014586377544	Diamond segment saw blade with open teeth, Ø 105 mm, Cutting width 1.2 mm	04	243
6 35 02 191 21 0	4014586389585	E-Cut carbide saw blade, Length 50 mm, Width 35 mm, Mount SLP	04	232
6 35 02 193 21 0	4014586389592	E-Cut diamond saw blade, Length 50 mm, Width 35 mm, Mount SLP	04	232
6 35 02 195 01 0	4014586378183	E-Cut diamond saw blade, Length 60 mm, Width 42 mm	04	243
6 35 02 196 01 0	4014586379531	Segment saw blade, Ø 100 mm, No. in pack 1 pcs	04	242
6 35 02 196 05 0	4014586379548	Segment saw blade, Ø 100 mm, No. in pack 5 pcs	04	242
6 35 02 196 21 0	4014586389608	HSS saw blade, Ø 100 mm, No. in pack 1 pcs, Mount SL	04	228
6 35 02 196 23 0	4014586389615	HSS saw blade, Ø 100 mm, No. in pack 5 pcs, Mount SL	04	228
6 35 02 200 21 0	4014586387178	E-Cut standard saw blade, Length 78 mm, Width 32 mm, No. in pack 1 pcs, Mount SLM	04	230
6 35 02 200 22 0	4014586387185	E-Cut standard saw blade, Length 78 mm, Width 32 mm, No. in pack 3 pcs, Mount SLM	04	230
6 35 02 200 23 0	4014586387192	E-Cut standard saw blade, Length 78 mm, Width 32 mm, No. in pack 5 pcs, Mount SLM	04	230
6 35 02 200 24 0	4014586387208	E-Cut standard saw blade, Length 78 mm, Width 32 mm, No. in pack 10 pcs, Mount SLM	04	230
6 35 02 200 25 0	4014586390710	E-Cut standard saw blade, Length 78 mm, Width 32 mm, No. in pack 50 pcs, Mount SLM	04	230
6 35 02 201 21 0	4014586387253	E-Cut long-life saw blade, Length 78 mm, Width 32 mm, No. in pack 1 pcs, Mount SLM	04	229
6 35 02 201 22 0	4014586387260	E-Cut long-life saw blade, Length 78 mm, Width 32 mm, No. in pack 3 pcs, Mount SLM	04	229
6 35 02 201 23 0	4014586387277	E-Cut long-life saw blade, Length 78 mm, Width 32 mm, No. in pack 5 pcs, Mount SLM	04	229
6 35 02 201 24 0	4014586387284	E-Cut long-life saw blade, Length 78 mm, Width 32 mm, No. in pack 10 pcs, Mount SLM	04	229
6 35 02 201 25 0	4014586390734	E-Cut long-life saw blade, Length 78 mm, Width 32 mm, No. in pack 50 pcs, Mount SLM	04	229
6 35 02 202 21 0	4014586387338	E-Cut standard saw blade, Length 78 mm, Width 42 mm, No. in pack 1 pcs, Mount SLM	04	230
6 35 02 202 22 0	4014586387345	E-Cut standard saw blade, Length 78 mm, Width 42 mm, No. in pack 3 pcs, Mount SLM	04	230
6 35 02 202 23 0	4014586387352	E-Cut standard saw blade, Length 78 mm, Width 42 mm, No. in pack 5 pcs, Mount SLM	04	230
6 35 02 202 24 0	4014586387369	E-Cut standard saw blade, Length 78 mm, Width 42 mm, No. in pack 10 pcs, Mount SLM	04	230
6 35 02 202 25 0	4014586390802	E-Cut standard saw blade, Length 78 mm, Width 42 mm, No. in pack 50 pcs, Mount SLM	04	230
6 35 02 203 21 0	4014586387413	E-Cut long-life saw blade, Length 78 mm, Width 42 mm, No. in pack 1 pcs, Mount SLM	04	229
6 35 02 203 22 0	4014586387420	E-Cut long-life saw blade, Length 78 mm, Width 42 mm, No. in pack 3 pcs, Mount SLM	04	229
6 35 02 203 23 0	4014586387437	E-Cut long-life saw blade, Length 78 mm, Width 42 mm, No. in pack 5 pcs, Mount SLM	04	229
6 35 02 203 24 0	4014586387444	E-Cut long-life saw blade, Length 78 mm, Width 42 mm, No. in pack 10 pcs, Mount SLM	04	229
6 35 02 203 25 0	4014586390826	E-Cut long-life saw blade, Length 78 mm, Width 42 mm, No. in pack 50 pcs, Mount SLM	04	229
6 35 02 204 21 0	4014586389622	E-Cut diamond saw blade, Length 60 mm, Width 44 mm, Mount SLM	04	232
6 35 02 205 21 0	4014586387499	E-Cut precision BIM saw blade, Length 50 mm, Width 35 mm, No. in pack 1 pcs, Mount SL	04	230
6 35 02 205 22 0	4014586387505	E-Cut precision BIM saw blade, Length 50 mm, Width 35 mm, No. in pack 3 pcs, Mount SL	04	230
6 35 02 205 23 0	4014586387512	E-Cut precision BIM saw blade, Length 50 mm, Width 35 mm, No. in pack 5 pcs, Mount SL	04	230
6 35 02 205 24 0	4014586387529	E-Cut precision BIM saw blade, Length 50 mm, Width 35 mm, No. in pack 10 pcs, Mount SL	04	230
6 35 02 205 25 0	4014586390840	E-Cut precision BIM saw blade, Length 50 mm, Width 35 mm, No. in pack 50 pcs, Mount SL	04	230
6 35 02 208 21 0	4014586387734	E-Cut precision BIM saw blade, Length 50 mm, Width 65 mm, No. in pack 1 pcs, Mount SLP	04	230
6 35 02 208 22 0	4014586387741	E-Cut precision BIM saw blade, Length 50 mm, Width 65 mm, No. in pack 3 pcs, Mount SLP	04	230

Part number	EAN	Description	PC	Page
6 35 02 208 23 0	4014586387758	E-Cut precision BIM saw blade, Length 50 mm, Width 65 mm, No. in pack 5 pcs, Mount SLP	04	230
6 35 02 208 24 0	4014586387765	E-Cut precision BIM saw blade, Length 50 mm, Width 65 mm, No. in pack 10 pcs, Mount SLP	04	230
6 35 02 208 25 0	4014586390901	E-Cut precision BIM saw blade, Length 50 mm, Width 65 mm, No. in pack 50 pcs, Mount SLP	04	230
6 35 02 209 01 0	4014586381602	E-Cut precision BIM saw blade, Width 35 mm, No. in pack 1 pcs	04	243
6 35 02 209 02 0	4014586381619	E-Cut precision BIM saw blade, Width 35 mm, No. in pack 5 pcs	04	243
6 35 02 209 03 0	4014586381626	E-Cut precision BIM saw blade, Width 35 mm, No. in pack 25 pcs	04	243
6 35 02 212 01 0	4014586381695	E-Cut precision BIM saw blade, Width 65 mm, No. in pack 1 pcs	04	243
6 35 02 212 02 0	4014586381701	E-Cut precision BIM saw blade, Width 65 mm, No. in pack 5 pcs	04	243
6 35 02 212 03 0	4014586381718	E-Cut precision BIM saw blade, Width 65 mm, No. in pack 25 pcs	04	243
6 35 02 213 23 0	4014586390932	Carbide saw blade, Ø 105 mm, No. in pack 5 pcs, Mount SLM	04	-
6 35 02 216 21 0	4014586390970	Diamond-coated saw blade, Ø 75 mm, No. in pack 1 pcs, Mount SL	04	236
6 35 02 216 23 0	4014586390987	Diamond-coated saw blade, Ø 75 mm, No. in pack 5 pcs, Mount SL	04	236
6 35 02 217 21 0	4014586390994	Diamond-coated saw blade, Ø 90 mm, No. in pack 1 pcs, Mount SLP	04	236
6 35 02 217 23 0	4014586391007	Diamond-coated saw blade, Ø 90 mm, No. in pack 5 pcs, Mount SLP	04	236
6 35 02 220 21 0	4014586391052	Diamond-coated saw blade, Ø 105 mm, Mount SLM	04	232
6 35 02 221 21 0	4014586400402	E-Cut long-life saw blade, Length 50 mm, Width 50 mm, No. in pack 1 pcs, Mount SL	04	229
6 35 02 221 22 0	4014586400419	E-Cut long-life saw blade, Length 50 mm, Width 50 mm, No. in pack 3 pcs, Mount SL	04	229
6 35 02 221 23 0	4014586400426	E-Cut long-life saw blade, Length 50 mm, Width 50 mm, No. in pack 5 pcs, Mount SL	04	229
6 35 02 221 24 0	4014586400433	E-Cut long-life saw blade, Length 50 mm, Width 50 mm, No. in pack 10 pcs, Mount SL	04	229
6 35 02 221 25 0	4014586400440	E-Cut long-life saw blade, Length 50 mm, Width 50 mm, No. in pack 50 pcs, Mount SL	04	229
6 35 02 222 21 0	4014586400457	E-Cut universal saw blade, Length 55 mm, Width 28 mm, No. in pack 1 pcs, Mount SL	04	231
6 35 02 222 22 0	4014586400464	E-Cut universal saw blade, Length 55 mm, Width 28 mm, No. in pack 3 pcs, Mount SL	04	231
6 35 02 222 23 0	4014586400471	E-Cut universal saw blade, Length 55 mm, Width 28 mm, No. in pack 5 pcs, Mount SL	04	231
6 35 02 222 24 0	4014586400488	E-Cut universal saw blade, Length 55 mm, Width 28 mm, No. in pack 10 pcs, Mount SL	04	231
6 35 02 222 25 0	4014586400495	E-Cut universal saw blade, Length 55 mm, Width 28 mm, No. in pack 50 pcs, Mount SL	04	231
6 35 02 223 21 0	4014586400501	E-Cut universal saw blade, Length 55 mm, Width 44 mm, No. in pack 1 pcs, Mount SL	04	231
6 35 02 223 22 0	4014586400518	E-Cut universal saw blade, Length 55 mm, Width 44 mm, No. in pack 3 pcs, Mount SL	04	231
6 35 02 223 23 0	4014586400525	E-Cut universal saw blade, Length 55 mm, Width 44 mm, No. in pack 5 pcs, Mount SL	04	231
6 35 02 223 24 0	4014586400532	E-Cut universal saw blade, Length 55 mm, Width 44 mm, No. in pack 10 pcs, Mount SL	04	231
6 35 02 223 25 0	4014586400549	E-Cut universal saw blade, Length 55 mm, Width 44 mm, No. in pack 50 pcs, Mount SL	04	231
6 35 02 224 21 0	4014586408170	E-Cut long-life saw blade, Length 90 mm, Width 32 mm, No. in pack 1 pcs, Mount SLM	04	229
6 35 02 224 22 0	4014586408187	E-Cut long-life saw blade, Length 90 mm, Width 32 mm, No. in pack 3 pcs, Mount SLM	04	229
6 35 02 224 23 0	4014586408194	E-Cut long-life saw blade, Length 90 mm, Width 32 mm, No. in pack 5 pcs, Mount SLM	04	229
6 35 02 224 24 0	4014586408200	E-Cut long-life saw blade, Length 90 mm, Width 32 mm, No. in pack 10 pcs, Mount SLM	04	229
6 35 02 224 25 0	4014586408217	E-Cut long-life saw blade, Length 90 mm, Width 32 mm, No. in pack 50 pcs, Mount SLM	04	229
6 35 02 225 21 0	4014586408262	E-Cut standard saw blade curved, Length 50 mm, Width 65 mm, No. in pack 1 pcs, Mount SL	04	230
6 35 02 225 22 0	4014586408279	E-Cut standard saw blade curved, Length 50 mm, Width 65 mm, No. in pack 3 pcs, Mount SL	04	230
6 35 02 225 23 0	4014586408286	E-Cut standard saw blade curved, Length 50 mm, Width 65 mm, No. in pack 5 pcs, Mount SL	04	230
6 35 02 225 24 0	4014586408293	E-Cut standard saw blade curved, Length 50 mm, Width 65 mm, No. in pack 10 pcs, Mount SL	04	230
6 35 02 225 25 0	4014586408309	E-Cut standard saw blade curved, Length 50 mm, Width 65 mm, No. in pack 50 pcs, Mount SL	04	230
6 35 02 226 21 0	4014586408354	E-Cut standard saw blade curved, Length 50 mm, Width 50 mm, No. in pack 1 pcs, Mount SL	04	230
6 35 02 226 22 0	4014586408361	E-Cut standard saw blade curved, Length 50 mm, Width 50 mm, No. in pack 3 pcs, Mount SL	04	230
6 35 02 226 23 0	4014586408378	E-Cut standard saw blade curved, Length 50 mm, Width 50 mm, No. in pack 5 pcs, Mount SL	04	230
6 35 02 226 24 0	4014586408385	E-Cut standard saw blade curved, Length 50 mm, Width 50 mm, No. in pack 10 pcs, Mount SL	04	230
6 35 02 226 25 0	4014586408392	E-Cut standard saw blade curved, Length 50 mm, Width 50 mm, No. in pack 50 pcs, Mount SL	04	230
6 35 02 227 21 0	4014586408446	E-Cut standard saw blade curved, Length 55 mm, Width 35 mm, No. in pack 1 pcs, Mount SL	04	230
6 35 02 227 22 0	4014586408453	E-Cut standard saw blade curved, Length 55 mm, Width 35 mm, No. in pack 3 pcs, Mount SL	04	230
6 35 02 227 23 0	4014586408460	E-Cut standard saw blade curved, Length 55 mm, Width 35 mm, No. in pack 5 pcs, Mount SL	04	230
6 35 02 227 24 0	4014586408477	E-Cut standard saw blade curved, Length 55 mm, Width 35 mm, No. in pack 10 pcs, Mount SL	04	230
6 35 02 227 25 0	4014586408484	E-Cut standard saw blade curved, Length 55 mm, Width 35 mm, No. in pack 50 pcs, Mount SL	04	230
6 35 02 228 21 0	4014586408538	E-Cut long-life saw blade, Length 50 mm, Width 65 mm, No. in pack 1 pcs, Mount SL	04	229
6 35 02 228 22 0	4014586408545	E-Cut long-life saw blade, Length 50 mm, Width 65 mm, No. in pack 3 pcs, Mount SL	04	229
6 35 02 228 23 0	4014586408552	E-Cut long-life saw blade, Length 50 mm, Width 65 mm, No. in pack 5 pcs, Mount SL	04	229
6 35 02 228 24 0	4014586408569	E-Cut long-life saw blade, Length 50 mm, Width 65 mm, No. in pack 10 pcs, Mount SL	04	229
6 35 02 228 25 0	4014586408576	E-Cut long-life saw blade, Length 50 mm, Width 65 mm, No. in pack 50 pcs, Mount SL	04	229
6 35 02 229 21 0	4014586408620	E-Cut precision BIM saw blade, Length 50 mm, Width 65 mm, No. in pack 1 pcs, Mount SL	04	230
6 35 02 229 22 0	4014586408637	E-Cut precision BIM saw blade, Length 50 mm, Width 65 mm, No. in pack 3 pcs, Mount SL	04	230
6 35 02 229 23 0	4014586408644	E-Cut precision BIM saw blade, Length 50 mm, Width 65 mm, No. in pack 5 pcs, Mount SL	04	230
6 35 02 229 24 0	4014586408651	E-Cut precision BIM saw blade, Length 50 mm, Width 65 mm, No. in pack 10 pcs, Mount SL	04	230
6 35 02 229 25 0	4014586408668	E-Cut precision BIM saw blade, Length 50 mm, Width 65 mm, No. in pack 50 pcs, Mount SL	04	230
6 35 02 230 21 0	4014586408712	E-Cut precision saw blade, Length 50 mm, Width 65 mm, No. in pack 1 pcs, Mount SL	04	231
6 35 02 230 22 0	4014586408729	E-Cut precision saw blade, Length 50 mm, Width 65 mm, No. in pack 3 pcs, Mount SL	04	231

Part number	EAN	Description	PC	Page
6 35 02 230 23 0	4014586408736	E-Cut precision saw blade, Length 50 mm, Width 65 mm, No. in pack 5 pcs, Mount SL	04	231
6 35 02 230 24 0	4014586408743	E-Cut precision saw blade, Length 50 mm, Width 65 mm, No. in pack 10 pcs, Mount SL	04	231
6 35 02 230 25 0	4014586408750	E-Cut precision saw blade, Length 50 mm, Width 65 mm, No. in pack 50 pcs, Mount SL	04	231
6 35 02 232 21 0	4014586417295	E-Cut precision BIM saw blade, Length 50 mm, Width 50 mm, No. in pack 1 pcs, Mount SL	04	230
6 35 02 232 22 0	4014586417301	E-Cut precision BIM saw blade, Length 50 mm, Width 50 mm, No. in pack 3 pcs, Mount SL	04	230
6 35 02 232 23 0	4014586417318	E-Cut precision BIM saw blade, Length 50 mm, Width 50 mm, No. in pack 5 pcs, Mount SL	04	230
6 35 02 232 24 0	4014586417325	E-Cut precision BIM saw blade, Length 50 mm, Width 50 mm, No. in pack 10 pcs, Mount SL	04	230
6 35 02 232 25 0	4014586417332	E-Cut precision BIM saw blade, Length 50 mm, Width 50 mm, No. in pack 50 pcs, Mount SL	04	230
6 35 02 233 21 0	4014586417387	E-Cut precision saw blade, Length 50 mm, Width 50 mm, No. in pack 1 pcs, Mount SL	04	231
6 35 02 233 22 0	4014586417394	E-Cut precision saw blade, Length 50 mm, Width 50 mm, No. in pack 3 pcs, Mount SL	04	231
6 35 02 233 23 0	4014586417400	E-Cut precision saw blade, Length 50 mm, Width 50 mm, No. in pack 5 pcs, Mount SL	04	231
6 35 02 233 24 0	4014586417417	E-Cut precision saw blade, Length 50 mm, Width 50 mm, No. in pack 10 pcs, Mount SL	04	231
6 35 02 233 25 0	4014586417424	E-Cut precision saw blade, Length 50 mm, Width 50 mm, No. in pack 50 pcs, Mount SL	04	231
6 35 02 234 01 0	4014586417479	E-Cut precision BIM saw blade, Width 50 mm, No. in pack 1 pcs	04	243
6 35 02 234 02 0	4014586417486	E-Cut precision BIM saw blade, Width 50 mm, No. in pack 5 pcs	04	243
6 35 02 234 03 0	4014586421049	E-Cut precision BIM saw blade, Width 50 mm, No. in pack 25 pcs	04	243
6 35 02 235 01 0	4014586417493	E-Cut precision saw blade, Width 50 mm, No. in pack 1 pcs	04	242
6 35 02 235 02 0	4014586417509	E-Cut precision saw blade, Width 50 mm, No. in pack 5 pcs	04	242
6 35 02 235 03 0	4014586421056	E-Cut precision saw blade, Width 50 mm, No. in pack 25 pcs	04	242
6 35 02 235 07 0	4014586425825	E-Cut precision saw blades, Width 50 mm, No. in pack 100 pcs	04	-
6 35 02 236 21 0	4014586427799	E-Cut Carbide Pro, Length 40 mm, Width 32 mm, No. in pack 1 pcs, Mount SL	04	231
6 35 02 236 22 0	4014586427805	E-Cut Carbide Pro, Length 40 mm, Width 32 mm, No. in pack 3 pcs, Mount SL	04	231
6 35 02 236 23 0	4014586427812	E-Cut Carbide Pro, Length 40 mm, Width 32 mm, No. in pack 5 pcs, Mount SL	04	231
6 35 02 236 24 0	4014586427829	E-Cut Carbide Pro, Length 40 mm, Width 32 mm, No. in pack 10 pcs, Mount SL	04	231
6 35 02 236 25 0	4014586427836	E-Cut Carbide Pro, Length 40 mm, Width 32 mm, No. in pack 50 pcs, Mount SL	04	231
6 35 02 237 21 0	4014586427874	E-Cut Carbide Pro, Length 60 mm, Width 32 mm, No. in pack 1 pcs, Mount SLP	04	231
6 35 02 237 22 0	4014586427881	E-Cut Carbide Pro, Length 60 mm, Width 32 mm, No. in pack 3 pcs, Mount SLP	04	231
6 35 02 237 23 0	4014586427898	E-Cut Carbide Pro, Length 60 mm, Width 32 mm, No. in pack 5 pcs, Mount SLP	04	231
6 35 02 237 24 0	4014586427904	E-Cut Carbide Pro, Length 60 mm, Width 32 mm, No. in pack 10 pcs, Mount SLP	04	231
6 35 02 237 25 0	4014586427911	E-Cut Carbide Pro, Length 60 mm, Width 32 mm, No. in pack 50 pcs, Mount SLP	04	231
6 35 02 238 21 0	4014586427959	E-Cut Carbide Pro, Length 75 mm, Width 32 mm, No. in pack 1 pcs, Mount SLM	04	231
6 35 02 238 22 0	4014586427966	E-Cut Carbide Pro, Length 75 mm, Width 32 mm, No. in pack 3 pcs, Mount SLM	04	231
6 35 02 238 23 0	4014586427973	E-Cut Carbide Pro, Length 75 mm, Width 32 mm, No. in pack 5 pcs, Mount SLM	04	231
6 35 02 238 24 0	4014586427980	E-Cut Carbide Pro, Length 75 mm, Width 32 mm, No. in pack 10 pcs, Mount SLM	04	231
6 35 02 238 25 0	4014586446639	E-Cut Carbide Pro, Length 75 mm, Width 32 mm, No. in pack 50 pcs, Mount SLM	04	-
6 35 02 301 00 0	4014586450803	Saw blade	02	145
6 35 02 302 00 0	4014586450810	Saw blade	02	145
6 35 02 303 00 0	4014586450827	Saw blade	02	145
6 35 02 304 00 0	4014586450834	Saw blade	02	145
6 35 03 037 01 8	4014586178936	Saw blade, Length 88 mm	02	140
6 35 03 038 01 6	4014586178943	Saw blade, Length 88 mm	02	140
6 35 03 039 01 0	4014586178950	Saw blade, Length 88 mm	02	140
6 35 03 040 00 3	4014586178967	Saw blade, Length 530 mm, Tooth spacing 6.3 mm, Thickness 1.5 mm	02	143
6 35 03 042 01 4	4014586178998	Saw blades	02	-
6 35 03 043 01 8	4014586179001	Saw blades, No. in pack 3 pcs	02	-
6 35 03 047 01 7	4014586179049	Saw blades, No. in pack 3 pcs	02	-
6 35 03 048 01 5	4014586179056	Saw blades, No. in pack 3 pcs	02	-
6 35 03 051 01 0	4014586179087	Saw blades, No. in pack 3 pcs	02	-
6 35 03 058 01 4	4014586179148	Saw blades, No. in pack 3 pcs	02	-
6 35 03 059 01 8	4014586179155	Saw blades, No. in pack 3 pcs	02	-
6 35 03 060 01 0	4014586179162	Saw blade, Length 77 mm	02	140
6 35 03 061 01 9	4014586179186	Saw blade, Length 77 mm	02	140
6 35 03 063 00 7	4014586179209	Saw blade, Length 300 mm, Tooth spacing 1.6 mm, Thickness 1.5 mm	02	143
6 35 03 064 00 5	4014586179216	Saw blade, Length 400 mm, Tooth spacing 1.6 mm, Thickness 1.5 mm	02	143
6 35 03 065 00 9	4014586179223	Saw blade, Length 200 mm, Tooth spacing 3.2 mm, Thickness 1.5 mm	02	143
6 35 03 066 00 2	4014586179230	Saw blade, Length 200 mm, Tooth spacing 1.6 mm, Thickness 1.5 mm	02	143
6 35 03 067 00 6	4014586179247	Saw blade, Length 200 mm, Tooth spacing 1 mm, Thickness 1.5 mm	02	143
6 35 03 068 00 4	4014586179254	Saw blade, Length 400 mm, Tooth spacing 3.2 mm, Thickness 1.5 mm	02	143
6 35 03 069 00 8	4014586179261	Saw blade, Length 530 mm, Tooth spacing 2.1 mm, Thickness 1.5 mm	02	143
6 35 03 070 00 0	4014586179278	Saw blade, Length 300 mm, Tooth spacing 2.1 mm, Thickness 1.5 mm	02	143
6 35 03 071 00 9	4014586179285	Saw blade, Length 300 mm, Tooth spacing 6.3 mm, Thickness 1.5 mm	02	143
6 35 03 072 00 2	4014586179292	Saw blade, Length 500 mm, Tooth spacing 1.8 mm, Thickness 2 mm	02	143

Part number	EAN	Description	PC	Page
6 35 03 073 00 6	4014586179308	Saw blade, Length 600 mm, Tooth spacing 1.8 mm, Thickness 2 mm	02	143
6 35 03 076 01 0	4014586179339	Saw blade, Length 100 mm	02	140
6 35 03 077 01 4	4014586179346	Saw blade, Length 120 mm	02	140
6 35 03 082 01 0	4014586179360	Saw blade, Length 100 mm	02	140
6 35 03 088 01 1	4014586179407	Saw blade, Length 100 mm	02	140
6 35 03 093 00 4	4014586200774	HD saw blades, Length 300 mm, Tooth spacing 1.6 mm, Thickness 2 mm	02	143
6 35 03 094 00 2	4014586200781	HD saw blades, Length 400 mm, Tooth spacing 2.1 mm, Thickness 2 mm	02	143
6 35 03 095 00 6	4014586200798	HD saw blades, Length 400 mm, Tooth spacing 3.2 mm, Thickness 2 mm	02	143
6 35 03 096 01 8	4014586202921	TD saw blades, Length 320 mm, Thickness 2.2 mm	02	143
6 35 03 097 01 2	4014586202938	TD saw blades, Length 490 mm, Thickness 2.9 mm	02	143
6 35 03 098 00 1	4014586212548	HD saw blades, Length 600 mm, Tooth spacing 1.8 mm, Thickness 2 mm	02	143
6 35 03 099 00 5	4014586212555	HD saw blades, Length 500 mm, Tooth spacing 1.8 mm, Thickness 2 mm	02	143
6 35 03 100 00 6	4014586212562	HD saw blades, Length 530 mm, Tooth spacing 2.1 mm, Thickness 1.6 mm	02	143
6 35 03 112 01 0	4014586305370	Saw blade, Length 88 mm	02	140
6 35 03 113 01 0	4014586305387	Saw blade, Length 88 mm	02	140
6 35 03 114 01 0	4014586305394	Saw blade, Length 180 mm	02	140
6 35 03 115 01 0	4014586305417	Saw blade, No. in pack 3 pcs	02	-
6 35 03 116 01 0	4014586305424	Saw blade, No. in pack 3 pcs	02	-
6 35 08 056 00 4	4014586179506	Form cutter, V-form 30°, Ø 125 mm, Width 25 mm, Teeth 32	08	-
6 35 08 081 00 9	4014586179513	Form cutter, V-form 30°, Ø 160 mm, Width 30 mm, Teeth 36	08	-
6 35 08 085 00 8	4014586179520	Form cutter, V-form 30°, Ø 180 mm, Width 42 mm, Teeth 36	08	-
6 35 08 093 00 0	4014586340395	Form cutter, V-form 37.5°, Ø 160 mm, Width 30 mm, Teeth 36	08	-
6 35 08 094 00 0	4014586340401	Form cutter, V-form 37.5°, Ø 180 mm, Width 42 mm, Teeth 36	08	-
6 35 08 098 00 0	4014586354613	Angled milling cutter, right	08	-
6 35 08 099 00 0	4014586354620	Angled milling cutter, left	08	-
6 36 01 101 00 9	4014586179766	Plunger blade and fixed blade, Plate thickness 1.6 mm	02	124
6 36 02 001 00 4	4014586179797	Cutter blades, up to 2.0 mm	02	-
6 36 02 046 00 2	4014586179834	Cutter blades, up to 2.0 mm	02	-
6 36 02 048 00 4	4014586224053	Punch, No. in pack 1 pcs	02	134
6 36 02 048 01 3	4014586246260	Punches and dies	02	134
6 36 02 048 04 0	4014586317984	Punch, No. in pack 5 pcs	02	134
6 36 02 048 05 0	4014586317991	Punch, No. in pack 10 pcs	02	134
6 36 02 049 00 8	4014586246611	Punch, No. in pack 1 pcs	02	134
6 36 02 049 01 7	4014586246628	Punches and dies	02	134
6 36 02 049 04 0	4014586318004	Punch, No. in pack 2 pcs	02	134
6 36 02 049 05 0	4014586318011	Punch, No. in pack 5 pcs	02	134
6 36 02 050 00 0	4014586264370	Punch, Plate thickness 1.3 mm, No. in pack 1 pcs	02	133
6 36 02 050 01 0	4014586269511	Punch, Plate thickness 1.3 mm, No. in pack 10 pcs	02	133
6 36 02 050 03 0	4014586318028	Punch, Plate thickness 1.3 mm, No. in pack 5 pcs	02	133
6 36 02 051 00 9	4014586262987	Punch	02	134
6 36 02 051 01 8	4014586264356	Punches and dies in a set	02	134
6 37 03 005 01 0	4014586450094	Grinding disc, Ø 125 mm, Thickness 6 mm	02	204
6 37 06 012 02 4	4014586260884	Diamond file	04	-
6 37 06 019 21 0	4014586389639	Carbide file, Length 30 mm, Width 10 mm, Mount SL	04	237
6 37 09 013 01 0	4014586450100	Cutting wheel, Ø 125 mm, Thickness 1 mm	02	204
6 37 09 014 01 0	4014586450117	Cutting wheel, Ø 125 mm, Thickness 2.5 mm	02	204
6 37 13 007 00 9	4014586180717	Grinding wheel	02	-
6 37 13 008 00 7	4014586180724	Grinding wheel	02	-
6 37 13 009 00 1	4014586180731	Grinding wheel	02	-
6 37 13 010 00 3	4014586180748	Grinding wheel	02	-
6 37 13 011 00 2	4014586180755	Polishing wheel	02	-
6 37 13 013 01 8	4014586226811	Polishing wheel	02	209
6 37 13 015 01 0	4014586226835	Polishing wheel	02	209
6 37 13 016 01 3	4014586226842	Polishing wheel	02	209
6 37 14 004 00 5	4014586180779	Linen sanding belt	02	-
6 37 14 006 00 2	4014586180793	Linen sanding belt	02	-
6 37 14 008 00 4	4014586180816	Linen sanding belt	02	-
6 37 14 014 00 4	4014586180878	Linen sanding belt	02	-
6 37 14 015 00 8	4014586180885	Linen sanding belt	02	-
6 37 14 044 01 0	4014586246406	Grinding belts, Grain 60, No. in pack 10 pcs	02	209
6 37 14 045 01 4	4014586246413	Grinding belts, Grain 120, No. in pack 10 pcs	02	209
6 37 14 046 01 7	4014586246420	Grinding belts, Grain 240, No. in pack 10 pcs	02	209

Part number	EAN	Description	PC	Page
6 37 14 047 01 1	4014586246437	Fleece strips, Model coarse	02	209
6 37 14 048 01 9	4014586246444	Fleece strips, Model medium	02	209
6 37 14 049 01 3	4014586246451	Fleece strips, Model fine	02	209
6 37 14 050 01 5	4014586259444	Grinding belts, No. in pack 10 pcs, Grain 120	02	203
6 37 14 050 02 1	4014586259451	Basic pipe sander set	02	203
6 37 14 051 01 4	4014586259468	Grinding belts, No. in pack 10 pcs, Grain 180	02	203
6 37 14 052 01 7	4014586259475	Grinding belts, No. in pack 10 pcs, Grain 320	02	203
6 37 14 053 01 1	4014586259499	Grinding belts, No. in pack 10 pcs, Grain 400	02	203
6 37 14 054 01 9	4014586259505	Grinding belts, No. in pack 10 pcs, Grain 120	02	203
6 37 14 055 01 3	4014586259512	Grinding belts, No. in pack 10 pcs, Grain 180	02	203
6 37 14 056 01 6	4014586259529	Fleece strips, No. in pack 5 pcs, Grain 80	02	203
6 37 14 057 01 0	4014586259536	Fleece strips, No. in pack 5 pcs, Grain 120	02	203
6 37 14 058 01 8	4014586259543	Fleece strips, No. in pack 5 pcs, Grain 280	02	203
6 37 14 061 01 0	4014586313160	Ceramic grinding belt, Grain 80, Width 3 mm	02	203
6 37 14 062 01 0	4014586313177	Ceramic grinding belt, Grain 120, Width 3 mm	02	203
6 37 14 063 01 0	4014586313184	Ceramic grinding belt, Grain 180, Width 3 mm	02	203
6 37 14 068 01 0	4014586313191	Ceramic grinding belt, Grain 80, Width 6 mm	02	203
6 37 14 069 01 0	4014586313207	Ceramic grinding belt, Grain 120, Width 6 mm	02	203
6 37 14 070 01 0	4014586313214	Ceramic grinding belt, Grain 180, Width 6 mm	02	203
6 37 14 089 01 0	4014586313221	Ceramic grinding belt, Grain 80, Width 20 mm	02	203
6 37 14 090 01 0	4014586313238	Ceramic grinding belt, Grain 120, Width 20 mm	02	203
6 37 14 091 01 0	4014586313245	Ceramic grinding belt, Grain 180, Width 20 mm	02	203
6 37 14 114 01 0	4014586313252	Fleece belt, Width 6 mm, Model coarse	02	204
6 37 14 115 01 0	4014586313269	Fleece belt, Width 6 mm, Model medium	02	204
6 37 14 116 01 0	4014586313276	Fleece belt, Width 6 mm, Model fine	02	204
6 37 14 123 01 0	4014586313283	Fleece belt, Width 20 mm, Model coarse	02	204
6 37 14 124 01 0	4014586313290	Fleece belt, Width 20 mm, Model medium	02	204
6 37 14 125 01 0	4014586313306	Fleece belt, Width 20 mm, Model fine	02	204
6 37 14 130 01 0	4014586300849	Ceramic sanding belts, Dimensions 20 x 815 mm, No. in pack 10 pcs, Grain 80	02	203
6 37 14 131 01 0	4014586300856	Ceramic sanding belts, Dimensions 40 x 815 mm, No. in pack 10 pcs, Grain 80	02	203
6 37 14 132 01 0	4014586305264	Sanding sleeve, Grain 60, No. in pack 5 pcs	02	210
6 37 14 133 01 0	4014586305271	Sanding sleeve, Grain 80, No. in pack 5 pcs	02	210
6 37 14 134 01 0	4014586306674	Sanding sleeve, Grain 120, No. in pack 5 pcs	02	210
6 37 14 136 01 0	4014586329512	Grinding belts, Grain 80	02	206
6 37 14 137 01 0	4014586329529	Grinding belts, Grain 120	02	206
6 37 14 138 01 0	4014586329536	Grinding belts, Grain 180	02	206
6 37 14 139 01 0	4014586329543	Grinding belts, Grain 320	02	206
6 37 14 140 01 0	4014586329741	Grinding belts, Grain 400	02	206
6 37 14 143 01 0	4014586329574	Fleece strips, Model fine	02	206
6 37 14 144 01 0	4014586330013	Polishing belts	02	206
6 37 14 145 01 0	4014586409672	Pyramix sanding sleeve, Grain 280, No. in pack 5 pcs	02	210
6 37 14 146 01 0	4014586409689	Pyramix sanding sleeve, Grain 400, No. in pack 5 pcs	02	210
6 37 14 147 01 0	4014586409696	Pyramix sanding sleeve, Grain 600, No. in pack 5 pcs	02	210
6 37 14 148 01 0	4014586409702	Pyramix sanding sleeve, Grain 1 400, No. in pack 5 pcs	02	210
6 37 17 081 01 8	4014586182575	Sanding sheets, Edge length 80 mm	04	233
6 37 17 081 04 6	4014586211114	Sanding sheets, Edge length 80 mm	04	233
6 37 17 082 01 1	4014586182612	Sanding sheets, Edge length 80 mm	04	233
6 37 17 082 03 3	4014586207667	Set of sanding sheets, Edge length 80 mm	04	233
6 37 17 082 04 9	4014586211121	Sanding sheets, Edge length 80 mm	04	233
6 37 17 083 01 5	4014586182643	Sanding sheets, Edge length 80 mm	04	233
6 37 17 083 04 3	4014586211138	Sanding sheets, Edge length 80 mm	04	233
6 37 17 084 01 3	4014586182674	Sanding sheets, Edge length 80 mm	04	233
6 37 17 084 04 1	4014586211145	Sanding sheets, Edge length 80 mm	04	233
6 37 17 085 01 7	4014586182704	Sanding sheets, Edge length 80 mm	04	233
6 37 17 085 04 5	4014586211152	Sanding sheets, Edge length 80 mm	04	233
6 37 17 086 01 0	4014586182728	Sanding sheets, Edge length 80 mm	04	233
6 37 17 086 04 8	4014586211107	Sanding sheets, Edge length 80 mm	04	233
6 37 17 087 01 4	4014586182742	Sanding sheets, Edge length 80 mm	04	233
6 37 17 087 04 2	4014586211169	Sanding sheets, Edge length 80 mm	04	233
6 37 17 088 01 2	4014586182773	Sanding sheets, Edge length 80 mm	04	233
6 37 17 088 04 0	4014586211176	Sanding sheets, Edge length 80 mm	04	233
6 37 17 089 01 6	4014586182797	Sanding sheets, Edge length 80 mm	04	233

Part number	EAN	Description	PC	Page
6 37 17 089 04 4	4014586211183	Sanding sheets, Edge length 80 mm	04	233
6 37 17 090 01 8	4014586182810	Sanding sheets, Edge length 80 mm	04	233
6 37 17 090 04 6	4014586211190	Sanding sheets, Edge length 80 mm	04	233
6 37 17 107 01 1	4014586182896	Sanding sheets, perforated, Edge length 80 mm	04	234
6 37 17 107 04 9	4014586211237	Sanding sheets, perforated, Edge length 80 mm	04	234
6 37 17 108 01 9	4014586182919	Sanding sheets, perforated, Edge length 80 mm	04	234
6 37 17 108 04 7	4014586211244	Sanding sheets, perforated, Edge length 80 mm	04	234
6 37 17 109 01 3	4014586182933	Sanding sheets, perforated, Edge length 80 mm	04	234
6 37 17 109 03 5	4014586213002	Set of sanding sheets, Edge length 80 mm	04	234
6 37 17 109 04 1	4014586211251	Sanding sheets, perforated, Edge length 80 mm	04	234
6 37 17 110 01 5	4014586182957	Sanding sheets, perforated, Edge length 80 mm	04	234
6 37 17 110 04 3	4014586211268	Sanding sheets, perforated, Edge length 80 mm	04	234
6 37 17 111 01 4	4014586182971	Sanding sheets, perforated, Edge length 80 mm	04	234
6 37 17 111 04 2	4014586211275	Sanding sheets, perforated, Edge length 80 mm	04	234
6 37 17 112 01 7	4014586182995	Sanding sheets, perforated, Edge length 80 mm	04	234
6 37 17 112 04 5	4014586211282	Sanding sheets, perforated, Edge length 80 mm	04	234
6 37 17 113 01 1	4014586183015	Sanding sheets, perforated, Edge length 80 mm	04	234
6 37 17 113 04 9	4014586211299	Sanding sheets, perforated, Edge length 80 mm	04	234
6 37 17 114 01 9	4014586183039	Sanding sheets, perforated, Edge length 80 mm	04	234
6 37 17 114 04 7	4014586211305	Sanding sheets, perforated, Edge length 80 mm	04	234
6 37 17 115 01 3	4014586183053	Sanding sheets, perforated, Edge length 80 mm	04	234
6 37 17 115 04 1	4014586211312	Sanding sheets, perforated, Edge length 80 mm	04	234
6 37 17 116 01 6	4014586183077	Sanding sheets, perforated, Edge length 80 mm	04	234
6 37 17 116 04 4	4014586211329	Sanding sheets, perforated, Edge length 80 mm	04	234
6 37 17 120 01 4	4014586183152	Stone sanding sheets, Edge length 80 mm	04	233
6 37 17 121 01 3	4014586183176	Stone sanding sheets, Edge length 80 mm	04	233
6 37 17 122 01 6	4014586183190	Stone sanding sheets, Edge length 80 mm	04	233
6 37 17 123 01 0	4014586183213	Stone sanding sheets, Edge length 80 mm	04	233
6 37 17 124 01 8	4014586183237	Stone sanding sheets, Edge length 80 mm	04	233
6 37 17 125 01 2	4014586183251	Stone sanding sheets, Edge length 80 mm	04	233
6 37 17 126 01 5	4014586183275	Supersoft sanding sheets, Edge length 80 mm	04	233
6 37 17 127 01 9	4014586183299	Supersoft sanding sheets, Edge length 80 mm	04	233
6 37 17 128 01 7	4014586183312	Supersoft sanding sheets, Edge length 80 mm	04	233
6 37 17 175 01 7	4014586183343	Stone sanding sheets, Edge length 80 mm	04	233
6 37 17 179 01 6	4014586201375	Supersoft sanding sheets, Edge length 80 mm	04	233
6 37 17 184 01 2	4014586208473	Sanding sheets for sanding fingers, Grain 40, No. in pack 20 pcs	04	233
6 37 17 185 01 6	4014586208480	Sanding sheets for sanding fingers, Grain 60, No. in pack 20 pcs	04	233
6 37 17 186 01 9	4014586208497	Sanding sheets for sanding fingers, Grain 80, No. in pack 20 pcs	04	233
6 37 17 187 01 3	4014586208503	Sanding sheets for sanding fingers, Grain 100, No. in pack 20 pcs	04	233
6 37 17 188 01 1	4014586208510	Sanding sheets for sanding fingers, Grain 120, No. in pack 20 pcs	04	233
6 37 17 189 01 5	4014586208527	Sanding sheets for sanding fingers, Grain 150, No. in pack 20 pcs	04	233
6 37 17 190 01 7	4014586208534	Sanding sheets for sanding fingers, Grain 180, No. in pack 20 pcs	04	233
6 37 17 191 01 6	4014586208541	Sanding sheets for sanding fingers, Grain 220, No. in pack 20 pcs	04	233
6 37 17 192 01 9	4014586208558	Sanding sheets for sanding fingers, Grain 240, No. in pack 20 pcs	04	233
6 37 17 217 01 6	4014586260914	Sandpaper for profile sanding set, Grain 80, No. in pack 25 pcs	04	234
6 37 17 218 01 4	4014586260921	Sandpaper for profile sanding set, Grain 120, No. in pack 25 pcs	04	234
6 37 17 219 01 8	4014586260938	Sandpaper for profile sanding set, Grain 180, No. in pack 25 pcs	04	234
6 37 17 221 01 0	4014586282893	Sanding disc	02	215
6 37 17 227 01 0	4014586317182	Set of sanding sheets	04	235
6 37 17 227 02 0	4014586317199	Sanding sheets, Grain 60, No. in pack 16 pcs	04	235
6 37 17 228 02 0	4014586317205	Sanding sheets, Grain 80, No. in pack 16 pcs	04	235
6 37 17 229 01 0	4014586317212	Sanding sheets, Grain 120, No. in pack 16 pcs	04	235
6 37 17 230 02 0	4014586317229	Sanding sheets, Grain 40, No. in pack 16 pcs	04	235
6 37 17 231 02 0	4014586317236	Sanding sheets, Grain 180, No. in pack 16 pcs	04	235
6 37 17 232 01 0	4014586317243	Sanding sheets, Grain 240, No. in pack 16 pcs	04	235
6 37 17 233 01 0	4014586329581	Sanding sheets, zirconium, Grain 40, No. in pack 12 pcs	04	235
6 37 17 233 02 0	4014586329598	Sanding sheet set, zirconium	04	235
6 37 17 234 01 0	4014586329604	Sanding sheets, zirconium, Grain 60, No. in pack 12 pcs	04	235
6 37 17 235 01 0	4014586329611	Sanding sheets, zirconium, Grain 80, No. in pack 12 pcs	04	235
6 37 17 236 01 0	4014586329628	Sanding sheets, zirconium, Edge length 80 mm	04	234
6 37 17 237 01 0	4014586329635	Sanding sheets, zirconium, Edge length 80 mm	04	234
6 37 17 238 01 0	4014586329642	Sanding sheets, zirconium, Edge length 80 mm	04	234

Part number	EAN	Description	PC	Page
6 37 17 239 01 0	4014586328768	Pyramix sanding sheet, Grain 280, No. in pack 5 pcs	02	205
6 37 17 239 02 0	4014586328775	Pyramix sanding sheet, Grain 280, No. in pack 25 pcs	02	205
6 37 17 240 01 0	4014586328782	Pyramix sanding sheet, Grain 400, No. in pack 5 pcs	02	205
6 37 17 240 02 0	4014586328799	Pyramix sanding sheet, Grain 400, No. in pack 25 pcs	02	205
6 37 17 241 01 0	4014586328805	Pyramix sanding sheet, Grain 800, No. in pack 5 pcs	02	205
6 37 17 241 02 0	4014586328812	Pyramix sanding sheet, Grain 800, No. in pack 25 pcs	02	205
6 37 17 242 01 0	4014586328829	Pyramix sanding sheet, Grain 1 400, No. in pack 5 pcs	02	205
6 37 17 242 02 0	4014586328836	Pyramix sanding sheet, Grain 1 400, No. in pack 25 pcs	02	205
6 37 17 243 01 0	4014586329659	Sanding sheets, zirconium, Edge length 80 mm	04	233
6 37 17 244 01 0	4014586329666	Sanding sheets, zirconium, Edge length 80 mm	04	233
6 37 17 245 01 0	4014586329673	Sanding sheets, zirconium, Edge length 80 mm	04	233
6 37 17 246 01 0	4014586373867	Sanding sheets, foam backing, Grain 500, No. in pack 5 pcs	04	235
6 37 17 247 01 0	4014586373874	Sanding sheets, foam backing, Grain 1000, No. in pack 5 pcs	04	235
6 37 17 293 02 0	4014586399157	Sanding sheets, perforated, Edge length 130 mm	04	234
6 37 17 294 02 0	4014586399164	Sanding sheets, perforated, Edge length 130 mm	04	234
6 37 17 295 02 0	4014586399171	Sanding sheets, perforated, Edge length 130 mm	04	234
6 37 17 296 02 0	4014586399188	Sanding sheets, perforated, Edge length 130 mm	04	234
6 37 17 297 02 0	4014586399195	Sanding sheets, perforated, Edge length 130 mm	04	234
6 37 17 298 01 0	4014586401430	Sanding sheets, zirconium, Edge length 130 mm	04	234
6 37 17 299 01 0	4014586401447	Sanding sheets, zirconium, Edge length 130 mm	04	234
6 37 17 300 01 0	4014586401454	Sanding sheets, zirconium, Edge length 130 mm	04	234
6 37 17 301 01 0	4014586450124	Fibre sanding disc, Ø 125 mm, No. in pack 25 pcs	02	204
6 37 17 302 01 0	4014586450131	Fibre sanding disc, Ø 125 mm, No. in pack 25 pcs	02	204
6 37 17 303 01 0	4014586450148	Fibre sanding disc, Ø 125 mm, No. in pack 25 pcs	02	204
6 37 18 011 01 0	4014586334998	Felt disc, Ø 150 mm, Thickness 6 mm	02	206
6 37 19 007 01 0	4014586213101	Cleaning block	04	144
6 37 19 010 01 4	4014586213453	Sharpening stone	04	250
6 37 19 011 01 0	4014586336466	Profiling stone	02	206
6 37 19 011 22 0	4014586389646	Tile joint cleaner, No. in pack 2 pcs, Mount SLP	04	237
6 37 21 001 00 1	4014586183428	Flap wheel, Ø 200 mm	02	209
6 37 21 003 01 7	4014586226583	Flap wheel	02	208
6 37 21 004 01 5	4014586226590	Flap wheel	02	208
6 37 21 005 01 9	4014586226606	Flap wheel	02	208
6 37 21 006 01 2	4014586246321	Elastic sanding cylinder, Grain 60, Model medium	02	208
6 37 21 006 04 0	4014586306629	Standard stainless steel set for surfaces	02	207
6 37 21 007 01 6	4014586246338	Elastic sanding cylinder, Grain 180, Model fine	02	208
6 37 21 008 01 4	4014586246345	Lamella fleece cylinder, Grain 100, Model medium	02	208
6 37 21 009 01 8	4014586246352	Lamella fleece cylinder, Grain 180, Model fine	02	208
6 37 21 010 01 0	4014586248448	Lamella fleece cylinder, Grain 280, Model very fine	02	208
6 37 21 015 01 0	4014586282329	Lamella fleece cylinder	02	208
6 37 21 050 02 0	4014586306636	Stainless steel set for satin-finishing surfaces	02	208
6 37 21 051 01 0	4014586305288	Sine fleece sanding cylinder, Grain 180, Model fine	02	208
6 37 21 052 01 0	4014586305189	Flap wheel, Grain 120	02	205
6 37 21 054 01 0	4014586328843	Elastic sanding cylinder, Grain 60, Model medium	02	208
6 37 21 054 02 0	4014586328850	Stainless steel set – Satin-finishing profiles	02	208
6 37 21 055 01 0	4014586328874	Elastic sanding cylinder, Grain 180, Model fine	02	208
6 37 21 056 01 0	4014586329062	Sine fleece sanding cylinder, Grain 180, Model fine	02	208
6 37 21 057 01 0	4014586409917	Felt lamella roller, Model soft	02	209
6 37 21 058 01 0	4014586409924	Felt lamella roller, Model medium	02	209
6 37 22 048 01 4	4014586226736	Nylon barrel brush	02	216
6 37 23 003 00 3	4014586183633	Lambskin, Ø 170 mm	02	216
6 37 23 007 00 2	4014586183688	Lambskin, Ø 120 mm	02	215
6 37 23 008 00 0	4014586216720	Lambskin, Ø 125 mm	02	207
6 37 23 009 00 4	4014586216737	Lambskin, Ø 150 mm	02	207
6 37 23 010 00 6	4014586216744	Lambskin, Ø 200 mm	02	207
6 37 23 011 01 4	4014586226637	Polishing rings, Sisal, cloth, Ø 150 mm	02	209
6 37 23 012 01 7	4014586226644	Polishing rings, Sisal, cloth, Ø 200 mm	02	209
6 37 23 013 01 1	4014586226651	Polishing rings, hard cloth, Ø 150 mm	02	209
6 37 23 014 01 9	4014586226668	Polishing rings, soft cloth, Ø 150 mm	02	209
6 37 23 015 01 3	4014586226675	Polishing rings, hard cloth, Ø 200 mm	02	209
6 37 23 016 01 6	4014586226682	Polishing rings, soft cloth, Ø 200 mm	02	209
6 37 23 017 01 0	4014586232829	Polishing sponge, Ø 125 mm, Model medium	02	215

Part number	EAN	Description	PC	Page
6 37 23 018 01 8	4014586232836	Polishing sponge, Ø 150 mm, Model medium	02	215
6 37 23 019 01 2	4014586233710	Polishing rings, fleece, extra soft, Ø 150 mm	02	209
6 37 23 020 01 4	4014586233727	Polishing rings, fleece, extra soft, Ø 200 mm	02	209
6 37 23 021 01 3	4014586233734	Sanding fleece, Ø 150 mm	02	209
6 37 23 022 01 6	4014586233741	Sanding fleece, Ø 200 mm	02	209
6 37 23 023 01 0	4014586233918	Polishing sponge, Ø 100 mm, Model hard	02	215
6 37 23 024 01 8	4014586233925	Polishing sponge, Ø 100 mm, Model soft	02	215
6 37 23 025 01 2	4014586233932	Polishing sponge, Ø 160 mm, Model hard	02	216
6 37 23 026 01 5	4014586233949	Polishing sponge, Ø 160 mm, Model soft	02	216
6 37 23 028 01 0	4014586282909	Polishing sponge orange 150 mm	02	215
6 37 23 029 01 0	4014586282930	Waffled sponge	02	215
6 37 23 031 01 0	4014586304939	Bristle fleece, No. in pack 2 pcs, Edge length 80 mm	04	235
6 37 23 032 01 0	4014586304946	Felt polishing pad, No. in pack 5 pcs, Edge length 80 mm	04	235
6 37 23 033 01 0	4014586304953	Bristle fleece, Ø 195 mm	02	216
6 37 23 034 01 0	4014586304960	Polishing sponge, Ø 195 mm	02	215
6 37 23 035 01 0	4014586304977	Lamb's wool, dome shape, Ø 230 mm	02	216
6 37 23 036 01 0	4014586335001	Felt polishing pad, No. in pack 5 pcs	04	235
6 37 23 037 01 0	4014586409931	Felt serrated disc, Model soft, Ø 125 mm	02	205
6 37 23 038 01 0	4014586409948	Felt serrated disc, Model medium, Ø 125 mm	02	205
6 37 26 010 01 8	4014586259574	Polishing belts	02	203
6 37 26 016 01 0	4014586313313	Polishing belt, Width 6 mm	02	204
6 37 26 019 01 0	4014586313320	Polishing belt, Width 20 mm	02	204
6 37 28 009 01 4	4014586184500	Sanding sheets, Grain 40, No. in pack 50 pcs	02	207
6 37 28 010 01 6	4014586184524	Sanding sheets, Grain 60, No. in pack 50 pcs	02	207
6 37 28 011 01 5	4014586184548	Sanding sheets	02	-
6 37 28 012 01 8	4014586184562	Sanding sheets, Grain 150, No. in pack 50 pcs	02	207
6 37 28 013 01 2	4014586184586	Sanding sheets, Grain 180, No. in pack 50 pcs	02	207
6 37 28 015 01 4	4014586184623	Sanding sheets, Grain 240, No. in pack 50 pcs	02	207
6 37 28 022 01 7	4014586184739	Sanding sheets, Grain 60, No. in pack 50 pcs	02	206
6 37 28 054 01 6	4014586185002	Sanding sheets, Grain 100, No. in pack 50 pcs	02	207
6 37 28 056 01 3	4014586185040	Sanding sheets, Grain 80, No. in pack 50 pcs	02	207
6 37 28 073 01 6	4014586185194	Sanding sheets, Grain 60, No. in pack 50 pcs	02	207
6 37 28 074 01 4	4014586185217	Sanding sheets, Grain 80, No. in pack 50 pcs	02	207
6 37 28 084 01 3	4014586185354	Sanding sheets, Grain 120, No. in pack 50 pcs	02	207
6 37 28 096 01 9	4014586215969	Sanding sheets, Grain 80, No. in pack 50 pcs	02	207
6 37 28 135 01 0	4014586329994	Sanding sheets, Grain 80, No. in pack 25 pcs	02	205
6 37 30 019 01 0	4014586409719	Flap wheel, Model soft, Ø 125 mm, No. in pack 5 pcs	02	205
6 37 30 020 01 0	4014586409726	Flap wheel, Model coarse, Ø 125 mm, No. in pack 5 pcs	02	205
6 37 30 021 01 0	4014586410296	Flap wheel, Model medium, Ø 125 mm, No. in pack 5 pcs	02	205
6 37 30 022 01 0	4014586450155	Flap wheel, Ø 125 mm, No. in pack 10 pcs	02	204
6 37 30 023 01 0	4014586450162	Flap wheel, Ø 125 mm, No. in pack 10 pcs	02	204
6 37 30 024 01 0	4014586450179	Flap wheel, Ø 125 mm, No. in pack 10 pcs	02	204
6 37 31 001 21 0	4014586391069	Carbide rasp, Edge length 80 mm, Mount SL	04	236
6 37 31 002 21 0	4014586391076	Carbide rasp, Mount SLP	04	236
6 37 31 006 21 0	4014586391083	Carbide rasp, Edge length 110 mm, Mount SLM	04	236
6 37 32 001 01 8	4014586226781	Fleece sanding discs, Model coarse, No. in pack 10 pcs	02	205
6 37 32 002 01 1	4014586226798	Fleece sanding discs, Model medium, No. in pack 10 pcs	02	205
6 37 32 003 01 5	4014586226804	Fleece sanding discs, Model fine, No. in pack 10 pcs	02	205
6 37 32 004 01 0	4014586305493	Sanding fleece for antifoul, Ø 150 mm, No. in pack 5 pcs	02	216
6 37 32 005 01 0	4014586305202	Finishing disc	02	205
6 37 33 001 01 0	4014586282992	Humidification sponge	02	215
6 37 33 002 01 0	4014586283005	Sanding block	02	215
6 37 33 003 01 0	4014586283012	Microfibre cloth	02	203
6 37 33 005 01 0	4014586309569	Adapter for FEIN SuperCut with QuickIN	04	245
6 37 33 006 01 0	4014586307312	Holder	02	210
6 37 33 010 01 0	4014586409733	Stainless steel masking tape, L 5 m	02	203
6 37 34 001 01 0	4014586334868	Fleece disc, Model coarse, Ø 150 mm, Thickness 3 mm	02	206
6 37 34 002 01 0	4014586334875	Fleece disc, Model coarse, Ø 150 mm, Thickness 6 mm	02	206
6 37 34 003 01 0	4014586334882	Fleece disc, Model medium, Ø 150 mm, Thickness 3 mm	02	206
6 37 34 004 01 0	4014586334899	Fleece disc, Model hard, Ø 150 mm, Thickness 6 mm	02	206
6 37 34 005 01 0	4014586334905	Fleece disc, Model fine, Ø 150 mm, Thickness 3 mm	02	206
6 37 34 006 01 0	4014586334912	Fleece disc, Model fine, Ø 150 mm, Thickness 6 mm	02	206

Part number	EAN	Description	PC	Page
6 37 34 007 01 0	4014586334929	Fleece disc, Model very fine, Ø 150 mm, Thickness 6 mm	02	206
6 37 34 008 01 0	4014586409740	Fleece disc, Model very course, Ø 150 mm, Thickness 7 mm	02	206
6 38 01 079 00 9	4014586185569	Inner flange	02	83
6 38 01 096 00 1	4014586185613	Inner flange	02	-
6 38 01 097 00 5	4014586185620	Grinding wheel	02	-
6 38 01 098 00 3	4014586185637	Flange	02	-
6 38 01 116 00 8	4014586185743	Flange	02	-
6 38 01 137 00 0	4014586185842	Flange	02	-
6 38 01 154 00 7	4014586185972	Threaded flange	02	204
6 38 01 176 01 1	4014586212517	Flange	02	-
6 38 01 178 00 4	4014586259857	adapter	02	-
6 38 01 181 00 0	4014586407883	Inner flange	02	-
6 38 01 182 01 0	4014586412405	Inner flange	02	204
6 38 01 183 01 0	4014586413662	Inner flange	02	-
6 38 02 052 00 0	4014586186115	Threaded flange	02	204
6 38 02 084 00 9	4014586186207	Threaded flange	02	83
6 38 02 098 00 7	4014586186238	Threaded flange	02	-
6 38 02 105 00 0	4014586186252	Threaded flange	02	-
6 38 02 106 00 3	4014586186269	Grinding wheel	02	-
6 38 02 107 00 7	4014586186276	Flange	02	-
6 38 02 178 02 3	4014586212890	Clamping unit	02	-
6 38 02 180 02 9	4014586212883	Clamping unit	02	-
6 38 02 182 00 6	4014586232805	Flange	02	-
6 38 02 183 02 5	4014586233314	Clamping unit	02	90
6 38 02 183 03 1	4014586233468	Clamping unit	02	-
6 38 02 185 02 7	4014586233321	Clamping unit	02	90
6 38 02 191 01 0	4014586356266	Quick-clamping nut	02	204
6 38 03 027 03 8	4014586228136	Wheel arbor	02	210
6 38 03 066 02 4	4014586226613	Wheel arbor	02	210
6 38 03 067 02 8	4014586226729	Wheel arbor, Length 100 mm	02	210
6 38 03 071 02 0	4014586328898	Wheel arbor, Length 50 mm	02	210
6 38 06 012 00 8	4014586186801	Backing pad, Ø 120 mm	02	215
6 38 06 030 00 4	4014586186832	Backing pad, Ø 170 mm	02	216
6 38 06 034 01 7	4014586186849	Elastic backing pad, Ø 180 mm	02	90
6 38 06 076 00 1	4014586187006	Contact disc	02	-
6 38 06 077 00 5	4014586187013	Contact disc	02	-
6 38 06 087 01 3	4014586187112	Elastic backing pad, Ø 125 mm	02	204
6 38 06 088 02 7	4014586187136	Sanding pad, Model medium	02	207
6 38 06 090 02 3	4014586187174	Sanding pad, Model medium	02	207
6 38 06 095 02 1	4014586187235	Sanding pad, Model medium	02	207
6 38 06 101 02 0	4014586187358	Sanding pad, Model hard	02	207
6 38 06 102 02 3	4014586187372	Sanding pad, Model hard	02	207
6 38 06 103 02 7	4014586187396	Sanding pad, Model hard	02	207
6 38 06 114 02 4	4014586187556	Sanding pad, Model soft	02	207
6 38 06 116 02 1	4014586187594	Sanding pad, Model hard	02	206
6 38 06 117 02 5	4014586187617	Sanding pad, Model soft	02	207
6 38 06 118 02 3	4014586187631	Sanding pad, Model extra soft	02	207
6 38 06 129 22 0	4014586391090	Sanding pad set, unperforated, Edge length 80 mm, Mount SL	04	232
6 38 06 136 22 0	4014586391106	Sanding pad set, perforated, Edge length 80 mm, Mount SL	04	234
6 38 06 138 01 5	4014586213798	Elastic backing pad	02	-
6 38 06 140 22 0	4014586391113	Felt polishing pad, Edge length 80 mm, Mount SL	04	235
6 38 06 141 22 0	4014586391120	Supersoft sanding pad, Edge length 80 mm, Mount SL	04	233
6 38 06 142 22 0	4014586391137	Sanding pad set, flat, Edge length 80 mm, Mount SL	04	232
6 38 06 143 01 7	4014586212906	Elastic backing pad	02	-
6 38 06 159 22 0	4014586391144	Sanding finger, No. in pack 2 pcs, Mount SL	04	233
6 38 06 166 02 6	4014586215990	Sanding pad, Model extra soft	02	206
6 38 06 167 02 0	4014586216003	Sanding pad	02	207
6 38 06 168 01 2	4014586226569	Backing pad, Ø 115 mm	02	205
6 38 06 169 01 6	4014586226743	Backing pad, Ø 125 mm	02	215
6 38 06 170 01 8	4014586226750	Backing pad, Ø 150 mm	02	215
6 38 06 171 01 7	4014586226767	Backing pad, Ø 200 mm	02	216
6 38 06 172 01 0	4014586226774	Backing pad, Ø 115 mm	02	205

Part number	EAN	Description	PC	Page
6 38 06 174 01 2	4014586233420	Elastic backing pad, Ø 180 mm	02	90
6 38 06 174 02 8	4014586233437	Elastic backing pad, Ø 180 mm	02	90
6 38 06 178 01 1	4014586233994	Backing pad, Ø 130 mm	02	215
6 38 06 179 01 5	4014586233956	Backing pad, Ø 80 mm	02	215
6 38 06 181 01 6	4014586246383	Sanding strip roll	02	209
6 38 06 181 03 0	4014586306698	Standard stainless steel set for pipes	02	208
6 38 06 186 01 0	4014586299228	Backing pad	02	–
6 38 06 187 01 0	4014586304984	Backing pad, Ø 170 mm	02	215
6 38 06 188 01 0	4014586304991	Sanding pad, Ø 150 mm	02	216
6 38 06 192 01 0	4014586305257	Expansion roller	02	210
6 38 06 192 02 0	4014586306704	Stainless steel set for grinding surfaces	02	208
6 38 06 193 01 0	4014586305363	Cool sanding pad, Ø 115 mm	02	205
6 38 06 193 04 0	4014586328911	Stainless steel set – Preparing to polish surfaces / pipes / profiles	02	205
6 38 06 195 21 0	4014586391151	Sanding set, Ø 115 mm, Mount SLP	04	235
6 38 06 196 01 0	4014586328935	Cool sanding pad, Ø 75 mm	02	205
6 38 06 204 21 0	4014586399201	Sanding set, Edge length 130 mm, Mount SLP	04	234
6 38 09 004 01 9	4014586246468	Adhesive strip	02	209
6 38 10 026 01 0	4014586313337	Stepped grinding arm, Belt width 3/6 mm	02	203
6 38 10 027 01 0	4014586313344	Straight grinding arm, Belt width 6 mm	02	203
6 38 10 030 01 0	4014586313351	Straight grinding arm, Belt width 20 mm	02	203
6 38 10 031 01 0	4014586392912	Profile grinding set, Mount SLP	04	233
6 38 11 004 01 0	4014586324838	Safety hood for cutting work, Ø 180 mm	02	90
6 38 11 005 01 0	4014586324845	Safety hood for cutting work, Ø 230 mm	02	90
6 38 11 008 01 0	4014586324852	Safety hood for cutting work	02	–
6 38 11 009 01 0	4014586324869	Safety hood for cutting work, Ø 180 mm	02	–
6 38 11 010 01 0	4014586324876	Safety hood for cutting work, Ø 230 mm	02	–
6 38 11 016 01 0	4014586392400	Safety hood for cutting work, Ø 115 mm	02	82
6 38 11 017 01 0	4014586392417	Safety hood for cutting work, Ø 125 mm	02	204
6 38 11 018 01 0	4014586392424	Safety hood for cutting work, Ø 150 mm	02	82
6 39 01 018 01 9	4014586241807	QuickIN-adaptors, Taper MT 2, Cutting depth 50 mm, Bore Ø 12 - 35 mm	02	184
6 39 01 019 01 3	4014586241814	QuickIN-adaptors, Taper MK 3, Cutting depth 50 mm, Bore Ø 12 - 65 mm	02	184
6 39 01 020 00 6	4014586241821	QuickIN-adaptor	02	183
6 39 01 021 01 4	4014586241845	QuickIN-adaptor	02	183
6 39 01 022 00 8	4014586241852	QuickIN-adaptor	02	183
6 39 01 023 00 2	4014586241869	QuickIN-adaptor	02	183
6 39 01 023 01 1	4014586258621	Key-type drill chuck with QuickIN holder, Chuck opening 3 - 16 mm	02	183
6 39 01 023 02 0	4014586317960	Key-type drill chuck with QuickIN holder, Chuck opening 1.5 - 13 mm	02	183
6 39 01 024 01 9	4014586244433	QuickIN-adaptor	02	183
6 39 01 027 01 0	4014586253480	Adapter with 3/4" Weldon fitting	02	183
6 39 01 028 01 8	4014586254685	Retro-fitting kit	02	–
6 39 01 030 01 4	4014586262796	High-speed construction screws, Ø 3.9 mm, L 35 mm, No. in pack 1,000 pcs	02	65
6 39 01 030 02 0	4014586331928	High-speed construction screws, Ø 3.9 mm, L 35 mm, No. in pack 10,000 pcs	02	65
6 39 01 031 01 3	4014586262802	High-speed construction screws, Ø 3.9 mm, L 30 mm, No. in pack 1,000 pcs	02	65
6 39 01 031 02 0	4014586331935	High-speed construction screws, Ø 3.9 mm, L 30 mm, No. in pack 10,000 pcs	02	65
6 39 01 032 01 6	4014586262819	High-speed construction screws, Ø 3.9 mm, L 35 mm, No. in pack 1,000 pcs	02	65
6 39 01 032 02 0	4014586331942	High-speed construction screws, Ø 3.9 mm, L 35 mm, No. in pack 10,000 pcs	02	65
6 39 01 033 01 0	4014586262826	High-speed construction screws, Ø 3.9 mm, L 45 mm, No. in pack 1,000 pcs	02	65
6 39 01 033 02 0	4014586331959	High-speed construction screws, Ø 3.9 mm, L 45 mm, No. in pack 10,000 pcs	02	65
6 39 01 034 01 8	4014586262833	High-speed construction screws, Ø 3.9 mm, L 30 mm, No. in pack 1,000 pcs	02	65
6 39 01 034 02 0	4014586331966	High-speed construction screws, Ø 3.9 mm, L 30 mm, No. in pack 10,000 pcs	02	65
6 39 01 035 02 0	4014586331973	High-speed construction screws, Ø 4.2 mm, L 35 mm, No. in pack 10,000 pcs	02	65
6 39 01 036 01 0	4014586274096	Gravity-fed cooling lubricant unit.	02	–
6 39 01 037 01 0	4014586274980	Contact and swarf protection	02	–
6 39 01 038 02 0	4014586298757	QuickIN MAX output, Taper MK 3, Cutting depth 50 mm, Bore Ø 50 - 80 mm	02	184
6 39 01 039 02 0	4014586310299	QuickIN output, Taper MK 3, Cutting depth 50 mm, Bore Ø 12 - 65 mm	02	184
6 39 01 040 01 0	4014586296647	Weldon 32 output, Mount Jancy	02	–
6 39 01 041 01 0	4014586296678	Weldon 32 output, Taper MK 3, Cutting depth 50 mm, Bore Ø 50 - 80 mm	02	184
6 39 01 042 01 0	4014586296685	Weldon 32 output, Mount Hougen	02	–
6 39 01 045 01 0	4014586317977	Adapter with QuickIN MAX / Weldon 32 fitting	02	183
6 39 01 047 00 0	4014586336756	QuickIN PLUS adapter on B16	02	–
6 39 01 048 02 0	4014586355528	QuickIN-adaptors, Taper MK 3, Cutting depth 50 mm, Bore Ø 12 - 65 mm	02	184
6 39 01 049 02 0	4014586355535	QuickIN-adaptors, Taper MK 3, Cutting depth 75 mm, Bore Ø 12 - 65 mm	02	184

Part number	EAN	Description	PC	Page
6 39 01 050 02 0	4014586355542	3/4" Weldon mounting shaft, Taper MK 3, Cutting depth 50 mm, Bore Ø 12 - 65 mm	02	184
6 39 01 051 02 0	4014586355559	3/4" Weldon mounting shaft, Taper MK 3, Cutting depth 75 mm, Bore Ø 12 - 65 mm	02	184
6 39 01 052 02 0	4014586355566	3/4" Weldon mounting shaft, Taper MK 3, Cutting depth 50 mm, Bore Ø 12 - 65 mm	02	184
6 39 01 053 02 0	4014586355573	3/4" Weldon mounting shaft, Taper MK 3, Cutting depth 75 mm, Bore Ø 12 - 65 mm	02	184
6 39 01 054 00 0	4014586365169	QuickIN Plus adapter for 1/2" -20 UNF	02	-
6 39 01 054 01 0	4014586365176	Quick-action chucks	02	-
6 39 01 055 02 0	4014586371160	QuickIN-adaptors, Taper MK 3, Cutting depth 75 mm, Bore Ø 12 - 65 mm	02	184
6 39 01 057 02 0	4014586371122	QuickIN-adaptors, Taper MT 2, Cutting depth 75 mm, Bore Ø 12 - 35 mm	02	184
6 39 01 061 00 0	4014586369235	Adapter with 3/4" Weldon fitting	02	183
6 39 01 061 02 0	4014586425245	Key-type drill chuck with 3/4" Weldon fitting, Chuck opening 1.5 - 13 mm	02	183
6 39 01 063 02 0	4014586403182	3/4" Weldon mounting shaft, Taper MT 2, Cutting depth 50 mm, Bore Ø 12 - 35 mm	02	184
6 39 01 064 02 0	4014586403199	3/4" Weldon mounting shaft, Taper MT 2, Cutting depth 75 mm, Bore Ø 12 - 35 mm	02	184
6 39 01 065 02 0	4014586403205	QuickIN-adaptors, Taper MT 2, Cutting depth 50 mm, Bore Ø 12 - 35 mm	02	184
6 39 01 066 02 0	4014586403212	QuickIN-adaptors, Taper MT 2, Cutting depth 75 mm, Bore Ø 12 - 35 mm	02	184
6 39 01 070 00 0	4014586407678	Adapter with 3/4" Weldon fitting	02	183
6 39 01 072 02 0	4014586425276	Weldon 32 mounting shaft, Taper MT 4, Cutting depth 50 mm, Bore Ø 50 - 100 mm	02	184
6 39 01 073 02 0	4014586425283	3/4" Weldon mounting shaft, Taper MK 3, Cutting depth 75 mm, Bore Ø 12 - 65 mm	02	184
6 39 01 074 02 0	4014586425290	3/4" Weldon mounting shaft, Taper MK 3, Cutting depth 50 mm, Bore Ø 12 - 65 mm	02	184
6 39 01 075 01 0	4014586425191	Adapter with Weldon 32 fitting	02	183
6 39 01 076 01 0	4014586425207	Adapter with QuickIN MAX / Weldon 32 fitting	02	183
6 39 01 077 02 0	4014586425306	1-1/4" Weldon mounting shaft, Taper MT 4, Cutting depth 50 mm, Bore Ø 50 - 100 mm	02	-
6 39 01 078 01 0	4014586425214	Adapter with 1-1/4" Weldon fitting	02	-
6 39 02 002 01 3	4014586188232	Paddle	02	29
6 39 03 072 01 7	4014586188577	Curved form, Cut length 45 mm, Total length 80 mm	04	252
6 39 03 073 01 1	4014586188584	Straight form, Cut length 35 mm, Total length 56 mm	04	250
6 39 03 076 01 6	4014586188621	U-shaped, Cut length 24 mm	04	251
6 39 03 079 01 2	4014586188645	U-shaped, Cut length 36 mm	04	251
6 39 03 081 01 3	4014586188676	Straight form, Cut length 60 mm, Total length 120 mm	04	250
6 39 03 082 01 6	4014586188683	Curved form, Cut length 14 mm, Total length 80 mm	04	252
6 39 03 087 01 9	4014586188737	U-shaped, Cut length 18 mm	04	251
6 39 03 095 01 1	4014586188799	U-shaped, Cut length 16 mm	04	251
6 39 03 097 01 8	4014586188829	Straight form, Cut length 58 mm, Total length 125 mm	04	252
6 39 03 099 01 0	4014586188850	Straight form, Cut length 16 mm, Total length 120 mm	04	252
6 39 03 101 01 0	4014586188874	U-shaped, Cut length 60 mm	04	251
6 39 03 103 01 7	4014586188898	Straight form, Cut length 35 mm, Total length 75 mm	04	252
6 39 03 104 01 5	4014586188904	Straight form, Cut length 16 mm, Total length 75 mm	04	252
6 39 03 105 01 9	4014586188911	Scraper knife, Cut length 25 mm, Total length 64 mm	04	251
6 39 03 107 01 6	4014586188935	U-shaped, Cut length 60 mm	04	251
6 39 03 108 01 4	4014586188942	U-shaped, Cut length 16 mm	04	251
6 39 03 109 01 8	4014586188959	Straight form, Cut length 35 mm, Total length 75 mm	04	252
6 39 03 110 01 0	4014586188966	U-shaped, Cut length 40 mm	04	251
6 39 03 111 01 9	4014586188973	U-shaped, Cut length 95 mm	04	251
6 39 03 113 01 6	4014586188997	Scraper knife, Cutting width 13 mm	04	251
6 39 03 113 02 2	4014586189000	Scraper knife set	04	251
6 39 03 114 01 4	4014586189017	U-shaped, Cut length 32 mm	04	251
6 39 03 115 01 8	4014586189031	U-shaped, Cut length 22 mm	04	251
6 39 03 116 01 1	4014586189048	Cutting blade	04	244
6 39 03 117 01 5	4014586189055	Cutting blade	04	244
6 39 03 118 01 3	4014586189062	U-shaped, Cut length 19.5 mm	04	251
6 39 03 120 01 9	4014586189086	Straight form, Cut length 14 mm, Total length 65 mm	04	252
6 39 03 121 01 8	4014586189093	Straight form, Cut length 26 mm, Total length 56 mm	04	251
6 39 03 122 01 1	4014586189109	Straight form, Cut length 19 mm, Total length 68 mm	04	251
6 39 03 123 01 5	4014586189116	Straight form, Cut length 32 mm, Total length 110 mm	04	251
6 39 03 124 01 3	4014586189123	Straight form, Cut length 25 mm, Total length 65 mm	04	251
6 39 03 125 01 7	4014586189130	Straight form, Cut length 70 mm, Total length 120 mm	04	252
6 39 03 128 01 2	4014586189161	Cutting blade	04	244
6 39 03 129 01 6	4014586189178	Scraper knife set	04	251
6 39 03 129 05 0	4014586210636	Scraper knife, Cut length 12 mm, Total length 64 mm	04	251
6 39 03 131 01 7	4014586210643	Scraper knife, Cutting width 25 mm	04	251
6 39 03 132 01 0	4014586189208	Segment blade, Cut length 30 mm, Total length 73 mm	04	244
6 39 03 133 01 4	4014586189215	Curved form, Cut length 16 mm, Total length 80 mm	04	252
6 39 03 143 01 3	4014586189314	Straight form, Cut length 16-43 mm, Total length 100 mm	04	252

Part number	EAN	Description	PC	Page
6 39 03 144 01 1	4014586189321	Scraper knife, Cutting width 13 mm	04	251
6 39 03 146 01 8	4014586189345	Scraper knife, Cut length 18 mm, Total length 65 mm	04	251
6 39 03 147 01 2	4014586189352	U-shaped, Cut length 32 mm	04	251
6 39 03 152 01 8	4014586189413	Curved form, Cut length 39 mm, Total length 85 mm	04	252
6 39 03 153 01 2	4014586189420	U-shaped, Cut length 52 mm	04	251
6 39 03 154 01 0	4014586189437	U-shaped, Cut length 45 mm	04	251
6 39 03 154 03 0	4014586269016	U-shaped, No. in pack 1 pcs	04	–
6 39 03 155 01 4	4014586189444	U-shaped, Cut length 70 mm	04	251
6 39 03 156 01 7	4014586193939	U-shaped, Cut length 40 mm	04	252
6 39 03 157 01 1	4014586195803	U-shaped, Cut length 60 mm	04	251
6 39 03 160 01 5	4014586198781	Straight form, Cut length 54 mm, Total length 120 mm	04	252
6 39 03 161 01 4	4014586198934	Cleaning blades	04	–
6 39 03 161 03 0	4014586315072	Cleaning blades	04	–
6 39 03 162 01 7	4014586198958	Segment blade, No. in pack 1 pcs	04	244
6 39 03 162 03 0	4014586315089	Segment blade, No. in pack 5 pcs	04	244
6 39 03 163 01 1	4014586200729	U-shaped, Cut length 28 mm	04	251
6 39 03 165 21 0	4014586389653	Flexible Scraper Blade, Mount SL	04	237
6 39 03 166 01 6	4014586208862	Segment saw blade	04	243
6 39 03 167 25 7	4014586240794	Automobile workshop accessories set	04	253
6 39 03 167 32 0	4014586252445	Accessory set for cargo	04	253
6 39 03 167 38 3	4014586265032	Automobile glazier accessory set	04	253
6 39 03 167 66 0	4014586343549	Accessory set for interior construction work with wood	04	245
6 39 03 167 67 0	4014586343556	Accessory set for repairing/replacing windows	04	245
6 39 03 168 01 8	4014586210247	Straight form, Cut length 45 mm, Total length 120 mm	04	252
6 39 03 169 01 2	4014586210261	Straight form, Cut length 60-76 mm, Total length 100 mm	04	252
6 39 03 170 01 4	4014586210285	Straight form, Cut length 18-39 mm, Total length 100 mm	04	252
6 39 03 171 01 3	4014586210308	Straight form, Cut length 70 mm, Total length 120 mm	04	251
6 39 03 172 01 6	4014586211978	Straight form, Cut length 35 mm, Total length 75 mm	04	252
6 39 03 173 01 0	4014586211985	Straight form, Cut length 23 mm, Total length 65 mm	04	251
6 39 03 174 01 8	4014586213736	Straight form, Cut length 27 mm, Total length 85 mm	04	251
6 39 03 176 01 5	4014586214245	Straight form, Cut length 40 mm, Total length 90 mm	04	251
6 39 03 177 01 9	4014586214252	Straight form, Cut length 65/8 mm, Total length 85 mm	04	252
6 39 03 181 01 2	4014586215785	Straight form, Cut length 18 mm, Total length 84 mm	04	251
6 39 03 182 01 5	4014586216010	Straight form, Cut length 42-60 mm, Total length 145 mm	04	252
6 39 03 183 01 9	4014586216539	Cutting blade, Blade width 3 mm, No. in pack 2 pcs	04	–
6 39 03 184 01 7	4014586216546	Cutting blade, Blade width 4 mm, No. in pack 2 pcs	04	–
6 39 03 185 01 1	4014586216553	Cutting blade, Blade width 5 mm, No. in pack 2 pcs	04	–
6 39 03 186 01 4	4014586216560	Cutting blade, Blade width 6 mm, No. in pack 2 pcs	04	–
6 39 03 191 01 1	4014586217376	U-shaped, Cut length 32 mm	04	251
6 39 03 194 01 6	4014586221878	Straight form, Cut length 35 mm, Total length 145 mm	04	251
6 39 03 195 01 0	4014586223513	Curved form, Cut length 32-46 mm, Total length 110 mm	04	252
6 39 03 196 01 3	4014586222974	Segment blade, No. in pack 1 pcs	04	244
6 39 03 196 02 0	4014586315096	Segment blade, No. in pack 5 pcs	04	244
6 39 03 197 01 7	4014586223506	Straight form	04	250
6 39 03 198 01 5	4014586223469	Straight form, Cut length 20-35 mm, Total length 100 mm	04	252
6 39 03 200 21 0	4014586389660	Cutting blade, Blade width 3 mm, Mount SLP	04	237
6 39 03 201 21 0	4014586389677	Cutting blade, Blade width 4 mm, Mount SLP	04	237
6 39 03 202 21 0	4014586389684	Cutting blade, Blade width 5 mm, Mount SLP	04	237
6 39 03 203 01 3	4014586228488	Straight form, Cut length 35/20 mm, Total length 83 mm	04	252
6 39 03 206 01 8	4014586240930	Scraper blade, Length 64 mm, No. in pack 2 pcs	04	244
6 39 03 207 01 2	4014586240947	L-shaped, Cut length 25.4 mm	04	251
6 39 03 208 01 0	4014586240954	L-shaped, Cut length 19 mm	04	251
6 39 03 209 01 4	4014586245133	L-shaped, Cut length 38 mm	04	251
6 39 03 210 01 6	4014586245140	U-shaped, Cut length 19 mm	04	251
6 39 03 211 01 5	4014586245157	U-shaped, Cut length 22.5 mm	04	251
6 39 03 212 01 8	4014586245164	U-shaped, Cut length 38 mm	04	251
6 39 03 216 01 7	4014586258164	Straight form, Cut length 60 mm, Total length 120 mm	04	252
6 39 03 216 02 0	4014586324302	Straight form, No. in pack 100 pcs	04	–
6 39 03 217 01 1	4014586265810	Hook-shaped, Cut length 38 mm	04	252
6 39 03 225 01 0	4014586294254	Carbide segment blade, No. in pack 1 pcs	04	244
6 39 03 225 02 0	4014586294261	Carbide segment blade, No. in pack 5 pcs	04	244
6 39 03 226 21 0	4014586389691	Fixed Scraper Blade, Mount SL	04	237

Part number	EAN	Description	PC	Page
6 39 03 227 01 0	4014586342078	Scraper blade, Length 72 mm, No. in pack 2 pcs	04	244
6 39 03 234 21 0	4014586389714	Fixed Scraper Blade, Mount SLP	04	237
6 39 03 236 23 0	4014586389776	Cutting blade, No. in pack 5 pcs, Mount SLM	04	237
6 39 03 237 21 0	4014586391175	Diamond cleaning knife, No. in pack 1 pcs, Mount SLM	04	237
6 39 03 237 23 0	4014586391182	Diamond cleaning knife, No. in pack 5 pcs, Mount SLM	04	237
6 39 03 238 21 0	4014586389738	Cutting blade, Mount SLM, No. in pack 1 pcs, Cutting depth 69 mm	04	237
6 39 03 238 31 0	4014586433363	Cutting blade, Mount SLM, No. in pack 100 pcs, Cutting depth 69 mm	04	-
6 39 03 239 23 0	4014586389745	Cutting blade, Mount SLM, No. in pack 5 pcs, Cutting depth 65 mm	04	237
6 39 03 240 21 0	4014586391199	Carbide saw blade, No. in pack 1 pcs, Mount SLM	04	236
6 39 03 240 23 0	4014586391205	Carbide saw blade, No. in pack 5 pcs, Mount SLM	04	236
6 39 03 241 21 0	4014586391212	Carbide saw blade, No. in pack 1 pcs, Mount SLM	04	236
6 39 03 241 23 0	4014586391229	Carbide saw blade, No. in pack 5 pcs, Mount SLM	04	236
6 39 03 242 21 0	4014586391236	Diamond-coated saw blade, No. in pack 1 pcs, Mount SLM	04	236
6 39 03 242 23 0	4014586391243	Diamond-coated saw blade, No. in pack 5 pcs, Mount SLM	04	236
6 39 03 243 21 0	4014586391250	Diamond-coated saw blade, No. in pack 1 pcs, Mount SLM	04	236
6 39 03 243 23 0	4014586391267	Diamond-coated saw blade, No. in pack 5 pcs, Mount SLM	04	236
6 39 03 244 22 0	4014586389783	Segment saw blade, No. in pack 2 pcs, Mount SLM	04	232
6 39 03 245 23 0	4014586389752	Cutting blade, No. in pack 5 pcs, Mount SL	04	237
6 39 03 251 21 0	4014586409276	Multi-function knife, No. in pack 1 pcs, Mount SL	04	237
6 39 03 251 23 0	4014586409283	Multi-function knife, No. in pack 5 pcs, Mount SL	04	237
6 39 98 611 03 0	4014586621241	Protecting lattice	02	-
6 42 01 001 00 0	4014586307305	Hook f. chip removal	02	-
6 42 01 005 01 0	4014586376554	Magbrush	02	145
6 42 03 001 00 0	4014586325118	Holder	02	-
6 42 03 002 01 0	4014586404844	Socket adapter, Accessory interface QuickIN	02	48
6 42 03 003 01 0	4014586404851	Tapping adapter, Accessory interface QuickIN	02	48
6 42 03 003 02 0	4014586414546	Tapping adapter, Accessory interface QuickIN	02	48
6 42 03 004 01 0	4014586404547	Extension	02	-
6 42 03 005 01 0	4014586404554	Extension	02	59
6 42 03 006 01 0	4014586420844	Drill chuck, Accessory interface QuickIN	02	48
6 42 03 007 01 0	4014586420851	Hole saw adapter, Accessory interface QuickIN	02	48
6 42 03 008 01 0	4014586422909	Angled head, Accessory interface QuickIN	02	48
6 42 03 009 01 0	4014586422985	Tapping collet, Ø 3.5 mm, Square 2.7 mm, Accessory interface QuickIN	02	48
6 42 03 010 01 0	4014586419961	Tapping collet, Ø 4.5 mm, Square 3.4 mm, Accessory interface QuickIN	02	48
6 42 03 011 01 0	4014586419978	Tapping collet, Ø 6 mm, Square 4.9 mm, Accessory interface QuickIN	02	48
6 42 03 012 01 0	4014586422992	Tapping collet, Ø 7 mm, Square 5.5 mm, Accessory interface QuickIN	02	48
6 42 03 013 01 0	4014586423005	Tapping collet, Ø 8 mm, Square 6.2 mm, Accessory interface QuickIN	02	48
6 42 03 014 01 0	4014586423012	Tapping collet, Ø 9 mm, Square 7 mm, Accessory interface QuickIN	02	48
6 42 03 015 01 0	4014586423029	Tapping collet, Ø 10 mm, Square 8 mm, Accessory interface QuickIN	02	48
6 42 03 016 01 0	4014586423203	Tapping collet, Ø 11 mm, Square 9 mm, Accessory interface QuickIN	02	48
6 42 03 017 02 0	4014586436401	QuickIN set of accessories for metal, Accessory interface QuickIN	02	48
6 42 04 001 01 0	4014586351988	Cutting wire	02	-
6 42 04 002 01 0	4014586354354	Anti-Metal-Cut set	02	-
6 42 04 003 01 0	4014586371177	Extension-set	02	-
6 43 01 001 01 0	4014586440972	Cutter	02	149
6 43 01 002 01 0	4014586440989	Cutter	02	149
6 43 01 003 01 0	4014586440996	Cutter	02	149
6 43 01 004 01 0	4014586441009	Cutter	02	149
6 43 01 007 01 0	4014586447780	Cutter	02	149
6 43 01 008 01 0	4014586447797	Cutter	02	149
6 43 02 001 01 0	4014586441016	SX indexable tip, No. in pack 10 pcs	02	148
6 43 02 002 01 0	4014586441023	SX indexable tip, No. in pack 10 pcs	02	148
6 43 02 003 01 0	4014586441030	KX indexable tip, No. in pack 10 pcs	02	149
6 43 02 004 01 0	4014586441047	KX indexable tip, No. in pack 10 pcs	02	149
6 43 02 005 01 0	4014586441054	KX indexable tip, No. in pack 10 pcs	02	149
6 43 02 006 01 0	4014586441061	KX indexable tip, No. in pack 10 pcs	02	149
6 43 02 007 01 0	4014586447803	SX indexable tip, No. in pack 10 pcs	02	148
6 43 02 008 01 0	4014586447810	SX indexable tip, No. in pack 10 pcs	02	148
6 43 02 009 01 0	4014586447827	SX indexable tip, No. in pack 10 pcs	02	148
6 43 02 010 01 0	4014586447834	SX indexable tip, No. in pack 10 pcs	02	148
6 43 02 011 01 0	4014586447841	KX indexable tip, No. in pack 10 pcs	02	149
6 43 02 012 01 0	4014586447858	KX indexable tip, No. in pack 10 pcs	02	149

Part number	EAN	Description	PC	Page
6 43 02 013 01 0	4014586447865	KX indexable tip, No. in pack 10 pcs	02	149
6 43 02 014 01 0	4014586447872	KX indexable tip, No. in pack 10 pcs	02	149
6 43 02 015 01 0	4014586447889	KX indexable tip, No. in pack 10 pcs	02	149
6 43 02 016 01 0	4014586447896	KX indexable tip, No. in pack 10 pcs	02	149
6 43 02 017 01 0	4014586447902	KX indexable tip, No. in pack 10 pcs	02	149
6 43 02 018 01 0	4014586447919	KX indexable tip, No. in pack 10 pcs	02	149
6 43 03 001 01 0	4014586441078	Guide roller	02	148
6 43 03 002 01 0	4014586441085	Guide roller	02	150
6 43 03 003 01 0	4014586441092	Guide roller	02	150
6 43 03 004 01 0	4014586441108	Guide roller	02	150
6 43 03 006 01 0	4014586447933	Guide roller	02	148
6 43 03 007 01 0	4014586447940	Guide roller	02	148
6 43 03 008 01 0	4014586447957	Guide roller	02	150
6 43 03 009 01 0	4014586447964	Guide roller	02	150
6 43 03 010 01 0	4014586447971	Guide roller	02	150
6 43 03 011 01 0	4014586447988	Guide roller	02	150
6 99 02 000 00 0	4014586277479	Dust container	13	276
6 99 02 000 14 6	4014586330693	Pipe cleaning unit	13	279
6 99 02 000 14 8	4014586369129	Stainless steel sanding support	13	276
6 99 02 000 14 9	4014586369136	Stainless steel sanding support	13	277
6 99 02 000 15 0	4014586369143	Mitre joint unit for preparation of welded seams	13	276
6 99 02 000 15 1	4014586369150	Mitre joint unit for preparation of welded seams	13	277
6 99 02 000 18 7	4014586372655	Contact roller, Ø 193.7 mm, Width 150.0 mm	13	278
6 99 02 000 40 9	4014586405292	Contact roller, Ø 16.0 mm, Width 50.0 mm	13	258
6 99 02 000 41 0	4014586405308	Contact roller, Ø 18.0 mm, Width 50.0 mm	13	258
6 99 02 000 41 1	4014586405315	Contact roller, Ø 19.0 mm, Width 50.0 mm	13	258
6 99 02 000 41 2	4014586405322	Contact roller, Ø 20.0 mm, Width 50.0 mm	13	258
6 99 02 000 41 3	4014586405339	Contact roller, Ø 21.0 mm, Width 50.0 mm	13	258
6 99 02 000 41 4	4014586405346	Contact roller, Ø 21.3 mm, Width 50.0 mm	13	258
6 99 02 000 41 5	4014586405353	Contact roller, Ø 22.0 mm, Width 50.0 mm	13	258
6 99 02 000 41 6	4014586405360	Contact roller, Ø 25.0 mm, Width 50.0 mm	13	258
6 99 02 000 41 7	4014586405377	Contact roller, Ø 25.4 mm, Width 50.0 mm	13	258
6 99 02 000 41 8	4014586405384	Contact roller, Ø 26.0 mm, Width 50.0 mm	13	258
6 99 02 000 41 9	4014586405391	Contact roller, Ø 26.9 mm, Width 50.0 mm	13	258
6 99 02 000 42 0	4014586405407	Contact roller, Ø 27.0 mm, Width 50.0 mm	13	258
6 99 02 000 42 1	4014586405414	Contact roller, Ø 28.0 mm, Width 50.0 mm	13	258
6 99 02 000 42 2	4014586405421	Contact roller, Ø 28.8 mm, Width 50.0 mm	13	258
6 99 02 000 42 3	4014586405438	Contact roller, Ø 30.0 mm, Width 50.0 mm	13	258
6 99 02 000 42 4	4014586405445	Contact roller, Ø 31.7 mm, Width 50.0 mm	13	258
6 99 02 000 42 6	4014586405469	Contact roller, Ø 33.0 mm, Width 50.0 mm	13	258
6 99 02 000 42 7	4014586405476	Contact roller, Ø 33.7 mm, Width 50.0 mm	13	258
6 99 02 000 42 8	4014586405483	Contact roller, Ø 34.0 mm, Width 50.0 mm	13	258
6 99 02 000 42 9	4014586405490	Contact roller, Ø 35.0 mm, Width 50.0 mm	13	258
6 99 02 000 43 0	4014586405506	Contact roller, Ø 38.0 mm, Width 50.0 mm	13	258
6 99 02 000 43 1	4014586405513	Contact roller, Ø 38.1 mm, Width 50.0 mm	13	258
6 99 02 000 43 2	4014586405520	Contact roller, Ø 38.3 mm, Width 50.0 mm	13	258
6 99 02 000 43 3	4014586405537	Contact roller, Ø 40.0 mm, Width 50.0 mm	13	258
6 99 02 000 43 4	4014586405544	Contact roller, Ø 42.0 mm, Width 50.0 mm	13	258
6 99 02 000 43 5	4014586405551	Contact roller, Ø 42.4 mm, Width 50.0 mm	13	258
6 99 02 001 00 0	4014586277486	Length stop	13	274
6 99 02 002 00 0	4014586277493	Adaptor	02	-
6 99 02 004 00 0	4014586277516	Stainless steel jaws	06	274
6 99 02 006 00 0	4014586277530	Steel wire brush, Wire thickness 0.20 mm	12	276
6 99 02 007 00 0	4014586277547	Steel wire brush, Wire thickness 0.35 mm	12	276
6 99 02 008 00 0	4014586277554	Steel wire brush, Wire thickness 0.50 mm	12	276
6 99 02 009 00 0	4014586277561	Steel wire brush, Wire thickness 0.20 mm	12	276
6 99 02 010 00 0	4014586277578	Steel wire brush, Wire thickness 0.35 mm	12	276
6 99 02 020 00 0	4014586277677	Contact roller, Ø 16.0 mm, Width 75.0 mm	13	275
6 99 02 021 00 0	4014586277684	Contact roller, Ø 17.0 mm, Width 75.0 mm	13	275
6 99 02 022 00 0	4014586277691	Contact roller, Ø 17.2 mm, Width 75.0 mm	13	275
6 99 02 023 00 0	4014586277707	Contact roller, Ø 18.0 mm, Width 75.0 mm	13	275
6 99 02 024 00 0	4014586277714	Contact roller, Ø 19.0 mm, Width 75.0 mm	13	275

Part number	EAN	Description	PC	Page
6 99 02 025 00 0	4014586277721	Contact roller, Ø 20.0 mm, Width 75.0 mm	13	275
6 99 02 026 00 0	4014586277738	Contact roller, Ø 21.0 mm, Width 75.0 mm	13	275
6 99 02 027 00 0	4014586277745	Contact roller, Ø 21.3 mm, Width 75.0 mm	13	275
6 99 02 028 00 0	4014586277752	Contact roller, Ø 22.0 mm, Width 75.0 mm	13	275
6 99 02 029 00 0	4014586277769	Contact roller, Ø 22.2 mm, Width 75.0 mm	13	275
6 99 02 030 00 0	4014586277776	Contact roller, Ø 22.5 mm, Width 75.0 mm	13	275
6 99 02 031 00 0	4014586277783	Contact roller, Ø 23.0 mm, Width 75.0 mm	13	275
6 99 02 032 00 0	4014586277790	Contact roller, Ø 23.1 mm, Width 75.0 mm	13	275
6 99 02 033 00 0	4014586277806	Contact roller, Ø 24.0 mm, Width 75.0 mm	13	275
6 99 02 034 00 0	4014586277813	Contact roller, Ø 24.5 mm, Width 75.0 mm	13	275
6 99 02 035 00 0	4014586277820	Contact roller, Ø 25.0 mm, Width 75.0 mm	13	275
6 99 02 036 00 0	4014586277837	Contact roller, Ø 25.4 mm, Width 75.0 mm	13	275
6 99 02 037 00 0	4014586277844	Contact roller, Ø 25.9 mm, Width 75.0 mm	13	275
6 99 02 038 00 0	4014586277851	Contact roller, Ø 26.0 mm, Width 75.0 mm	13	275
6 99 02 039 00 0	4014586277868	Contact roller, Ø 26.4 mm, Width 75.0 mm	13	275
6 99 02 040 00 0	4014586277875	Contact roller, Ø 26.9 mm, Width 75.0 mm	13	275
6 99 02 041 00 0	4014586277882	Contact roller, Ø 27.0 mm, Width 75.0 mm	13	275
6 99 02 042 00 0	4014586277899	Contact roller, Ø 28.0 mm, Width 75.0 mm	13	275
6 99 02 043 00 0	4014586277905	Contact roller, Ø 28.6 mm, Width 75.0 mm	13	275
6 99 02 044 00 0	4014586277912	Contact roller, Ø 28.8 mm, Width 75.0 mm	13	275
6 99 02 045 00 0	4014586277929	Contact roller, Ø 29.0 mm, Width 75.0 mm	13	275
6 99 02 046 00 0	4014586277936	Contact roller, Ø 30.0 mm, Width 75.0 mm	13	275
6 99 02 047 00 0	4014586277943	Contact roller, Ø 31.7 mm, Width 75.0 mm	13	275
6 99 02 048 00 0	4014586277950	Contact roller, Ø 32.0 mm, Width 75.0 mm	13	275
6 99 02 049 00 0	4014586277967	Contact roller, Ø 33.0 mm, Width 75.0 mm	13	275
6 99 02 050 00 0	4014586277974	Contact roller, Ø 33.7 mm, Width 75.0 mm	13	275
6 99 02 051 00 0	4014586277981	Contact roller, Ø 34.0 mm, Width 75.0 mm	13	275
6 99 02 052 00 0	4014586277998	Contact roller, Ø 35.0 mm, Width 75.0 mm	13	275
6 99 02 053 00 0	4014586278001	Contact roller, Ø 36.0 mm, Width 75.0 mm	13	275
6 99 02 054 00 0	4014586278018	Contact roller, Ø 37.5 mm, Width 75.0 mm	13	275
6 99 02 055 00 0	4014586278025	Contact roller, Ø 38.0 mm, Width 75.0 mm	13	275
6 99 02 056 00 0	4014586278032	Contact roller, Ø 38.1 mm, Width 75.0 mm	13	275
6 99 02 057 00 0	4014586278049	Contact roller, Ø 38.3 mm, Width 75.0 mm	13	275
6 99 02 058 00 0	4014586278056	Contact roller, Ø 40.0 mm, Width 75.0 mm	13	275
6 99 02 059 00 0	4014586278063	Contact roller, Ø 41.0 mm, Width 75.0 mm	13	275
6 99 02 060 00 0	4014586278070	Contact roller, Ø 41.2 mm, Width 75.0 mm	13	275
6 99 02 061 00 0	4014586278087	Contact roller, Ø 42.0 mm, Width 75.0 mm	13	275
6 99 02 062 00 0	4014586278094	Contact roller, Ø 42.4 mm, Width 75.0 mm	13	275
6 99 02 063 00 0	4014586278100	Contact roller, Ø 42.6 mm, Width 75.0 mm	13	275
6 99 02 064 00 0	4014586278117	Contact roller, Ø 43.0 mm, Width 75.0 mm	13	275
6 99 02 065 00 0	4014586278124	Contact roller, Ø 43.3 mm, Width 75.0 mm	13	275
6 99 02 066 00 0	4014586278131	Contact roller, Ø 44.0 mm, Width 75.0 mm	13	275
6 99 02 067 00 0	4014586278148	Contact roller, Ø 44.5 mm, Width 75.0 mm	13	275
6 99 02 068 00 0	4014586278155	Contact roller, Ø 45.0 mm, Width 75.0 mm	13	275
6 99 02 069 00 0	4014586278162	Contact roller, Ø 46.0 mm, Width 75.0 mm	13	275
6 99 02 070 00 0	4014586278179	Contact roller, Ø 48.0 mm, Width 75.0 mm	13	275
6 99 02 071 00 0	4014586278186	Contact roller, Ø 48.3 mm, Width 75.0 mm	13	275
6 99 02 072 00 0	4014586278193	Contact roller, Ø 49.0 mm, Width 75.0 mm	13	275
6 99 02 073 00 0	4014586278209	Contact roller, Ø 50.0 mm, Width 75.0 mm	13	275
6 99 02 074 00 0	4014586278216	Contact roller, Ø 50.8 mm, Width 75.0 mm	13	275
6 99 02 075 00 0	4014586278223	Contact roller, Ø 51.0 mm, Width 75.0 mm	13	275
6 99 02 076 00 0	4014586278230	Contact roller, Ø 53.0 mm, Width 75.0 mm	13	275
6 99 02 077 00 0	4014586278247	Contact roller, Ø 53.7 mm, Width 75.0 mm	13	275
6 99 02 078 00 0	4014586278254	Contact roller, Ø 54.0 mm, Width 75.0 mm	13	275
6 99 02 079 00 0	4014586278261	Contact roller, Ø 55.0 mm, Width 75.0 mm	13	275
6 99 02 080 00 0	4014586278278	Contact roller, Ø 57.0 mm, Width 75.0 mm	13	275
6 99 02 081 00 0	4014586278285	Contact roller, Ø 58.0 mm, Width 75.0 mm	13	275
6 99 02 082 00 0	4014586278292	Contact roller, Ø 59.0 mm, Width 75.0 mm	13	275
6 99 02 083 00 0	4014586278308	Contact roller, Ø 60.0 mm, Width 75.0 mm	13	275
6 99 02 084 00 0	4014586278315	Contact roller, Ø 60.3 mm, Width 75.0 mm	13	275
6 99 02 085 00 0	4014586278322	Contact roller, Ø 63.0 mm, Width 75.0 mm	13	275
6 99 02 086 00 0	4014586278339	Contact roller, Ø 63.5 mm, Width 75.0 mm	13	275

Part number	EAN	Description	PC	Page
6 99 02 087 00 0	4014586278346	Contact roller, Ø 65.0 mm, Width 75.0 mm	13	275
6 99 02 088 00 0	4014586278353	Contact roller, Ø 67.0 mm, Width 75.0 mm	13	275
6 99 02 089 00 0	4014586278360	Contact roller, Ø 69.0 mm, Width 75.0 mm	13	275
6 99 02 090 00 0	4014586278377	Contact roller, Ø 70.0 mm, Width 75.0 mm	13	275
6 99 02 091 00 0	4014586278384	Contact roller, Ø 73.0 mm, Width 75.0 mm	13	275
6 99 02 092 00 0	4014586278391	Contact roller, Ø 75.0 mm, Width 75.0 mm	13	275
6 99 02 093 00 0	4014586278407	Contact roller, Ø 76.0 mm, Width 75.0 mm	13	275
6 99 02 094 00 0	4014586278414	Contact roller, Ø 76.1 mm, Width 75.0 mm	13	275
6 99 02 095 00 0	4014586278421	Contact roller, Ø 76.2 mm, Width 75.0 mm	13	275
6 99 02 096 00 0	4014586278438	Contact roller, Ø 80.0 mm, Width 75.0 mm	13	275
6 99 02 097 00 0	4014586278445	Contact roller, Ø 82.5 mm, Width 75.0 mm	13	275
6 99 02 098 00 0	4014586278452	Contact roller, Ø 88.9 mm, Width 75.0 mm	13	275
6 99 02 099 00 0	4014586278469	Contact roller, Ø 90.0 mm, Width 75.0 mm	13	275
6 99 02 100 00 0	4014586278476	Grinding/cooling emulsion	13	276
6 99 02 101 00 0	4014586283098	Contact roller, Ø 20.0 mm, Width 150.0 mm	13	277
6 99 02 102 00 0	4014586283104	Contact roller, Ø 22.0 mm, Width 150.0 mm	13	277
6 99 02 103 00 0	4014586283111	Contact roller, Ø 25.0 mm, Width 150.0 mm	13	277
6 99 02 104 00 0	4014586283128	Contact roller, Ø 25.4 mm, Width 150.0 mm	13	277
6 99 02 105 00 0	4014586283135	Contact roller, Ø 26.9 mm, Width 150.0 mm	13	277
6 99 02 106 00 0	4014586283142	Contact roller, Ø 28.0 mm, Width 150.0 mm	13	277
6 99 02 107 00 0	4014586283159	Contact roller, Ø 30.0 mm, Width 150.0 mm	13	277
6 99 02 108 00 0	4014586283166	Contact roller, Ø 32.0 mm, Width 150.0 mm	13	277
6 99 02 109 00 0	4014586283173	Contact roller, Ø 33.7 mm, Width 150.0 mm	13	277
6 99 02 110 00 0	4014586283180	Contact roller, Ø 35.0 mm, Width 150.0 mm	13	277
6 99 02 111 00 0	4014586283197	Contact roller, Ø 38.0 mm, Width 150.0 mm	13	277
6 99 02 112 00 0	4014586283203	Contact roller, Ø 38.1 mm, Width 150.0 mm	13	277
6 99 02 113 00 0	4014586283210	Contact roller, Ø 38.3 mm, Width 150.0 mm	13	277
6 99 02 114 00 0	4014586283227	Contact roller, Ø 40.0 mm, Width 150.0 mm	13	277
6 99 02 115 00 0	4014586283234	Contact roller, Ø 42.4 mm, Width 150.0 mm	13	277
6 99 02 116 00 0	4014586283241	Contact roller, Ø 44.5 mm, Width 150.0 mm	13	277
6 99 02 117 00 0	4014586283258	Contact roller, Ø 48.3 mm, Width 150.0 mm	13	277
6 99 02 118 00 0	4014586283265	Contact roller, Ø 50.0 mm, Width 150.0 mm	13	277
6 99 02 119 00 0	4014586283272	Contact roller, Ø 50.8 mm, Width 150.0 mm	13	277
6 99 02 120 00 0	4014586283289	Contact roller, Ø 60.0 mm, Width 150.0 mm	13	277
6 99 02 121 00 0	4014586283296	Contact roller, Ø 60.3 mm, Width 150.0 mm	13	277
6 99 02 122 00 0	4014586283302	Contact roller, Ø 63.5 mm, Width 150.0 mm	13	277
6 99 02 123 00 0	4014586283319	Contact roller, Ø 69.0 mm, Width 150.0 mm	13	277
6 99 02 125 00 0	4014586283333	Contact roller, Ø 76.2 mm, Width 150.0 mm	13	277
6 99 02 126 00 0	4014586283340	Contact roller, Ø 84.0 mm, Width 150.0 mm	13	277
6 99 02 127 00 0	4014586283357	Contact roller, Ø 88.9 mm, Width 150.0 mm	13	277
6 99 02 128 00 0	4014586283364	Contact roller, Ø 101.6 mm, Width 150.0 mm	13	277
6 99 02 129 00 0	4014586283371	Contact roller, Ø 104.0 mm, Width 150.0 mm	13	277
6 99 02 130 00 0	4014586283388	Contact roller, Ø 108.0 mm, Width 150.0 mm	13	277
6 99 02 131 00 0	4014586283395	Contact roller, Ø 114.3 mm, Width 150.0 mm	13	278
6 99 02 132 00 0	4014586283401	Contact roller, Ø 133.0 mm, Width 150.0 mm	13	278
6 99 02 133 00 0	4014586283418	Contact roller, Ø 139.7 mm, Width 150.0 mm	13	278
6 99 02 134 00 0	4014586283425	Contact roller, Ø 168.3 mm, Width 150.0 mm	13	278
6 99 02 155 00 0	4014586284835	Contact roller, Ø 152.4 mm, Width 150.0 mm	13	278
6 99 02 176 00 0	4014586285528	Swivel joint GIT	13	279
6 99 02 179 60 0	4014586349381	Pipe support	13	275
6 99 02 180 60 0	4014586351193	Pipe support, max. pipe length 1,000 mm	13	275
6 99 02 181 60 0	4014586351209	Pipe support, max. pipe length 1,500 mm	13	275
6 99 02 182 00 0	4014586285580	Adaptor	13	278
6 99 02 183 00 0	4014586285597	Plugbox 2 x 7 poles	13	279
6 99 02 188 00 0	4014586290683	Contact roller, Ø 16.0 mm, Width 150.0 mm	13	277
6 99 02 189 00 0	4014586290706	Contact roller, Ø 18.0 mm, Width 150.0 mm	13	277
6 99 02 190 00 0	4014586290713	Contact roller, Ø 19.0 mm, Width 150.0 mm	13	277
6 99 02 191 00 0	4014586290720	Contact roller, Ø 19.1 mm, Width 150.0 mm	13	277
6 99 02 192 00 0	4014586290737	Contact roller, Ø 21.0 mm, Width 150.0 mm	13	277
6 99 02 193 00 0	4014586290744	Contact roller, Ø 21.3 mm, Width 150.0 mm	13	277
6 99 02 194 00 0	4014586290751	Contact roller, Ø 22.3 mm, Width 150.0 mm	13	277
6 99 02 195 00 0	4014586290768	Contact roller, Ø 23.0 mm, Width 150.0 mm	13	277

Part number	EAN	Description	PC	Page
6 99 02 196 00 0	4014586290775	Contact roller, Ø 23.2 mm, Width 150.0 mm	13	277
6 99 02 197 00 0	4014586290782	Contact roller, Ø 24.3 mm, Width 150.0 mm	13	277
6 99 02 198 00 0	4014586290799	Contact roller, Ø 26.1 mm, Width 150.0 mm	13	277
6 99 02 199 00 0	4014586290805	Contact roller, Ø 26.7 mm, Width 150.0 mm	13	277
6 99 02 200 00 0	4014586290812	Contact roller, Ø 27.0 mm, Width 150.0 mm	13	277
6 99 02 201 00 0	4014586290829	Contact roller, Ø 28.3 mm, Width 150.0 mm	13	277
6 99 02 202 00 0	4014586290836	Contact roller, Ø 28.6 mm, Width 150.0 mm	13	277
6 99 02 203 00 0	4014586290843	Contact roller, Ø 29.2 mm, Width 150.0 mm	13	277
6 99 02 204 00 0	4014586290850	Contact roller, Ø 31.1 mm, Width 150.0 mm	13	277
6 99 02 205 00 0	4014586290867	Contact roller, Ø 31.5 mm, Width 150.0 mm	13	277
6 99 02 206 00 0	4014586290874	Contact roller, Ø 31.8 mm, Width 150.0 mm	13	277
6 99 02 207 00 0	4014586290881	Contact roller, Ø 33.0 mm, Width 150.0 mm	13	277
6 99 02 208 00 0	4014586290898	Contact roller, Ø 33.4 mm, Width 150.0 mm	13	277
6 99 02 209 00 0	4014586290904	Contact roller, Ø 34.0 mm, Width 150.0 mm	13	277
6 99 02 210 00 0	4014586290911	Contact roller, Ø 37.4 mm, Width 150.0 mm	13	277
6 99 02 211 00 0	4014586290928	Contact roller, Ø 39.8 mm, Width 150.0 mm	13	277
6 99 02 212 00 0	4014586290935	Contact roller, Ø 40.1 mm, Width 150.0 mm	13	277
6 99 02 213 00 0	4014586290942	Contact roller, Ø 41.3 mm, Width 150.0 mm	13	277
6 99 02 214 00 0	4014586290959	Contact roller, Ø 42.0 mm, Width 150.0 mm	13	277
6 99 02 215 00 0	4014586290966	Contact roller, Ø 42.1 mm, Width 150.0 mm	13	277
6 99 02 216 00 0	4014586290973	Contact roller, Ø 42.2 mm, Width 150.0 mm	13	277
6 99 02 217 00 0	4014586290980	Contact roller, Ø 43.0 mm, Width 150.0 mm	13	277
6 99 02 218 00 0	4014586290997	Contact roller, Ø 45.0 mm, Width 150.0 mm	13	277
6 99 02 219 00 0	4014586291000	Contact roller, Ø 45.7 mm, Width 150.0 mm	13	277
6 99 02 221 00 0	4014586291024	Contact roller, Ø 47.4 mm, Width 150.0 mm	13	277
6 99 02 222 00 0	4014586291031	Contact roller, Ø 48.0 mm, Width 150.0 mm	13	277
6 99 02 223 00 0	4014586291048	Contact roller, Ø 49.0 mm, Width 150.0 mm	13	277
6 99 02 224 00 0	4014586291055	Contact roller, Ø 50.1 mm, Width 150.0 mm	13	277
6 99 02 225 00 0	4014586291062	Contact roller, Ø 51.0 mm, Width 150.0 mm	13	277
6 99 02 226 00 0	4014586291086	Contact roller, Ø 53.0 mm, Width 150.0 mm	13	277
6 99 02 227 00 0	4014586291093	Contact roller, Ø 93.2 mm, Width 150.0 mm	13	277
6 99 02 228 00 0	4014586291109	Contact roller, Ø 107.0 mm, Width 150.0 mm	13	277
6 99 02 229 00 0	4014586291116	Contact roller, Ø 54.0 mm, Width 150.0 mm	13	277
6 99 02 230 00 0	4014586291123	Contact roller, Ø 55.0 mm, Width 150.0 mm	13	277
6 99 02 231 00 0	4014586291130	Contact roller, Ø 57.0 mm, Width 150.0 mm	13	277
6 99 02 232 00 0	4014586291147	Contact roller, Ø 57.8 mm, Width 150.0 mm	13	277
6 99 02 233 00 0	4014586291154	Contact roller, Ø 58.0 mm, Width 150.0 mm	13	277
6 99 02 234 00 0	4014586291161	Contact roller, Ø 59.5 mm, Width 150.0 mm	13	277
6 99 02 235 00 0	4014586291178	Contact roller, Ø 62.0 mm, Width 150.0 mm	13	277
6 99 02 236 00 0	4014586291185	Contact roller, Ø 63.0 mm, Width 150.0 mm	13	277
6 99 02 237 00 0	4014586291192	Contact roller, Ø 64.2 mm, Width 150.0 mm	13	277
6 99 02 238 00 0	4014586291208	Contact roller, Ø 65.0 mm, Width 150.0 mm	13	277
6 99 02 239 00 0	4014586291215	Contact roller, Ø 66.0 mm, Width 150.0 mm	13	277
6 99 02 240 00 0	4014586291222	Contact roller, Ø 66.3 mm, Width 150.0 mm	13	277
6 99 02 241 00 0	4014586291239	Contact roller, Ø 66.7 mm, Width 150.0 mm	13	277
6 99 02 242 00 0	4014586291246	Contact roller, Ø 67.1 mm, Width 150.0 mm	13	277
6 99 02 243 00 0	4014586291253	Contact roller, Ø 69.9 mm, Width 150.0 mm	13	277
6 99 02 244 00 0	4014586291260	Contact roller, Ø 70.0 mm, Width 150.0 mm	13	277
6 99 02 245 00 0	4014586291277	Contact roller, Ø 73.0 mm, Width 150.0 mm	13	277
6 99 02 246 00 0	4014586291284	Contact roller, Ø 73.8 mm, Width 150.0 mm	13	277
6 99 02 247 00 0	4014586291291	Contact roller, Ø 75.0 mm, Width 150.0 mm	13	277
6 99 02 248 00 0	4014586291307	Contact roller, Ø 75.1 mm, Width 150.0 mm	13	277
6 99 02 249 00 0	4014586291314	Contact roller, Ø 76.0 mm, Width 150.0 mm	13	277
6 99 02 250 00 0	4014586291321	Contact roller, Ø 78.0 mm, Width 150.0 mm	13	277
6 99 02 251 00 0	4014586291338	Contact roller, Ø 79.4 mm, Width 150.0 mm	13	277
6 99 02 252 00 0	4014586291345	Contact roller, Ø 79.8 mm, Width 150.0 mm	13	277
6 99 02 253 00 0	4014586291352	Contact roller, Ø 80.0 mm, Width 150.0 mm	13	277
6 99 02 254 00 0	4014586291369	Contact roller, Ø 80.2 mm, Width 150.0 mm	13	277
6 99 02 255 00 0	4014586291376	Contact roller, Ø 81.0 mm, Width 150.0 mm	13	277
6 99 02 256 00 0	4014586291383	Contact roller, Ø 82.0 mm, Width 150.0 mm	13	277
6 99 02 257 00 0	4014586291390	Contact roller, Ø 82.1 mm, Width 150.0 mm	13	277
6 99 02 258 00 0	4014586291406	Contact roller, Ø 82.5 mm, Width 150.0 mm	13	277

Part number	EAN	Description	PC	Page
6 99 02 259 00 0	4014586291413	Contact roller, Ø 83.0 mm, Width 150.0 mm	13	277
6 99 02 260 00 0	4014586291420	Contact roller, Ø 84.1 mm, Width 150.0 mm	13	277
6 99 02 261 00 0	4014586291437	Contact roller, Ø 85.0 mm, Width 150.0 mm	13	277
6 99 02 262 00 0	4014586291444	Contact roller, Ø 86.7 mm, Width 150.0 mm	13	277
6 99 02 263 00 0	4014586291451	Contact roller, Ø 87.0 mm, Width 150.0 mm	13	277
6 99 02 264 00 0	4014586291468	Contact roller, Ø 88.0 mm, Width 150.0 mm	13	277
6 99 02 265 00 0	4014586291475	Contact roller, Ø 89.0 mm, Width 150.0 mm	13	277
6 99 02 266 00 0	4014586291482	Contact roller, Ø 89.3 mm, Width 150.0 mm	13	277
6 99 02 267 00 0	4014586291499	Contact roller, Ø 89.9 mm, Width 150.0 mm	13	277
6 99 02 268 00 0	4014586291505	Contact roller, Ø 90.0 mm, Width 150.0 mm	13	277
6 99 02 269 00 0	4014586291512	Contact roller, Ø 92.0 mm, Width 150.0 mm	13	277
6 99 02 271 00 0	4014586291543	Contact roller, Ø 100.0 mm, Width 150.0 mm	13	277
6 99 02 272 00 0	4014586291635	Contact roller, Ø 100.5 mm, Width 150.0 mm	13	277
6 99 02 273 00 0	4014586291642	Contact roller, Ø 101.0 mm, Width 150.0 mm	13	277
6 99 02 274 00 0	4014586291659	Contact roller, Ø 101.3 mm, Width 150.0 mm	13	277
6 99 02 275 00 0	4014586291987	Contact roller, Ø 102.0 mm, Width 150.0 mm	13	277
6 99 02 276 00 0	4014586291994	Contact roller, Ø 102.5 mm, Width 150.0 mm	13	277
6 99 02 277 00 0	4014586292007	Contact roller, Ø 102.6 mm, Width 150.0 mm	13	277
6 99 02 278 00 0	4014586292014	Contact roller, Ø 105.0 mm, Width 150.0 mm	13	277
6 99 02 279 00 0	4014586292021	Contact roller, Ø 106.7 mm, Width 150.0 mm	13	277
6 99 02 281 00 0	4014586292045	Contact roller, Ø 110.0 mm, Width 150.0 mm	13	277
6 99 02 282 00 0	4014586292052	Contact roller, Ø 114.0 mm, Width 150.0 mm	13	278
6 99 02 283 00 0	4014586292069	Contact roller, Ø 115.0 mm, Width 150.0 mm	13	278
6 99 02 284 00 0	4014586292076	Contact roller, Ø 117.0 mm, Width 150.0 mm	13	278
6 99 02 285 00 0	4014586292083	Contact roller, Ø 118.0 mm, Width 150.0 mm	13	278
6 99 02 286 00 0	4014586292090	Contact roller, Ø 118.2 mm, Width 150.0 mm	13	278
6 99 02 287 00 0	4014586292106	Contact roller, Ø 120.0 mm, Width 150.0 mm	13	278
6 99 02 288 00 0	4014586292113	Contact roller, Ø 121.0 mm, Width 150.0 mm	13	278
6 99 02 289 00 0	4014586293080	Contact roller, Ø 122.0 mm, Width 150.0 mm	13	278
6 99 02 290 00 0	4014586292120	Contact roller, Ø 124.0 mm, Width 150.0 mm	13	278
6 99 02 291 00 0	4014586292137	Contact roller, Ø 125.0 mm, Width 150.0 mm	13	278
6 99 02 292 00 0	4014586292144	Contact roller, Ø 127.0 mm, Width 150.0 mm	13	278
6 99 02 293 00 0	4014586292151	Contact roller, Ø 127.5 mm, Width 150.0 mm	13	278
6 99 02 294 00 0	4014586292168	Contact roller, Ø 128.0 mm, Width 150.0 mm	13	278
6 99 02 295 00 0	4014586292175	Contact roller, Ø 129.0 mm, Width 150.0 mm	13	278
6 99 02 296 00 0	4014586292182	Contact roller, Ø 130.0 mm, Width 150.0 mm	13	278
6 99 02 297 00 0	4014586292199	Contact roller, Ø 135.0 mm, Width 150.0 mm	13	278
6 99 02 298 00 0	4014586292205	Contact roller, Ø 138.0 mm, Width 150.0 mm	13	278
6 99 02 299 00 0	4014586292212	Contact roller, Ø 139.0 mm, Width 150.0 mm	13	278
6 99 02 300 00 0	4014586292229	Contact roller, Ø 140.0 mm, Width 150.0 mm	13	278
6 99 02 301 00 0	4014586292236	Contact roller, Ø 141.3 mm, Width 150.0 mm	13	278
6 99 02 302 00 0	4014586292243	Contact roller, Ø 141.9 mm, Width 150.0 mm	13	278
6 99 02 303 00 0	4014586292250	Contact roller, Ø 144.2 mm, Width 150.0 mm	13	278
6 99 02 304 00 0	4014586292267	Contact roller, Ø 15.0 mm, Width 75.0 mm	13	275
6 99 02 305 00 0	4014586292274	Contact roller, Ø 150.0 mm, Width 150.0 mm	13	278
6 99 02 306 00 0	4014586292281	Contact roller, Ø 152.0 mm, Width 150.0 mm	13	278
6 99 02 308 00 0	4014586292304	Contact roller, Ø 154.0 mm, Width 150.0 mm	13	278
6 99 02 309 00 0	4014586292311	Contact roller, Ø 159.0 mm, Width 150.0 mm	13	278
6 99 02 310 00 0	4014586292328	Contact roller, Ø 160.0 mm, Width 150.0 mm	13	278
6 99 02 311 00 0	4014586292335	Contact roller, Ø 163.0 mm, Width 150.0 mm	13	278
6 99 02 312 00 0	4014586292342	Contact roller, Ø 165.0 mm, Width 150.0 mm	13	278
6 99 02 313 00 0	4014586292359	Contact roller, Ø 165.1 mm, Width 150.0 mm	13	278
6 99 02 314 00 0	4014586292366	Contact roller, Ø 168.0 mm, Width 150.0 mm	13	278
6 99 02 315 00 0	4014586292373	Contact roller, Ø 172.2 mm, Width 150.0 mm	13	-
6 99 02 316 00 0	4014586292380	Contact roller, Ø 180.0 mm, Width 150.0 mm	13	-
6 99 02 317 00 0	4014586292397	Contact roller, Ø 188.4 mm, Width 150.0 mm	13	-
6 99 02 318 00 0	4014586292403	Contact roller, Ø 190.0 mm, Width 150.0 mm	13	-
6 99 02 319 00 0	4014586292410	Contact roller, Ø 195.0 mm, Width 150.0 mm	13	-
6 99 02 320 00 0	4014586292427	Contact roller, Ø 202.0 mm, Width 150.0 mm	13	-
6 99 02 321 00 0	4014586292533	Contact roller, Ø 215.0 mm, Width 150.0 mm	13	-
6 99 02 322 00 0	4014586292540	Contact roller, Ø 219.0 mm, Width 150.0 mm	13	-
6 99 02 323 00 0	4014586292557	Contact roller, Ø 31.0 mm, Width 75.0 mm	13	275

Part number	EAN	Description	PC	Page
6 99 02 324 00 0	4014586292564	Contact roller, Ø 57.5 mm, Width 75.0 mm	13	275
6 99 02 326 00 0	4014586292588	Contact roller, Ø 68.0 mm, Width 75.0 mm	13	275
6 99 02 327 00 0	4014586292595	Contact roller, Ø 84.0 mm, Width 75.0 mm	13	275
6 99 02 332 00 0	4014586295435	Contact roller, Ø 68.9 mm, Width 150.0 mm	13	277
6 99 02 338 00 0	4014586299488	Stainless steel sanding support	13	274
6 99 02 343 00 0	4014586349398	Spark box	13	274
6 99 02 344 00 0	4014586349404	Stainless steel sanding support	13	276
6 99 02 410 00 0	4014586299310	Drive wheel puller	07	279
6 99 03 000 00 0	4014586278483	Grinding material R, Grain 24, No. in pack 10 pcs	12	273
6 99 03 002 00 0	4014586278506	Grinding material R, Grain 36, No. in pack 10 pcs	12	273
6 99 03 003 00 0	4014586278513	Grinding material Z, Grain 36, No. in pack 10 pcs	12	273
6 99 03 004 00 0	4014586278520	Grinding material R, Grain 40, No. in pack 10 pcs	12	273
6 99 03 005 00 0	4014586278537	Grinding material Z, Grain 40, No. in pack 10 pcs	12	273
6 99 03 007 00 0	4014586278551	Grinding material R, Grain 60, No. in pack 10 pcs	12	273
6 99 03 008 00 0	4014586278568	Grinding material Z, Grain 60, No. in pack 10 pcs	12	273
6 99 03 009 00 0	4014586278575	Grinding material R, Grain 80, No. in pack 10 pcs	12	273
6 99 03 010 00 0	4014586278582	Grinding material Z, Grain 80, No. in pack 10 pcs	12	273
6 99 03 013 00 0	4014586278612	Grinding material R, Grain 120, No. in pack 10 pcs	12	273
6 99 03 014 00 0	4014586278629	Grinding material Z, Grain 120, No. in pack 10 pcs	12	273
6 99 03 017 00 0	4014586278650	Grinding material A, Grain 220, No. in pack 10 pcs	12	274
6 99 03 018 00 0	4014586278667	Grinding material A, Grain 320, No. in pack 10 pcs	12	274
6 99 03 019 00 0	4014586278674	Grinding material A, Grain 400, No. in pack 10 pcs	12	274
6 99 03 020 00 0	4014586278681	Grinding material R, Grain 36, No. in pack 10 pcs	12	273
6 99 03 021 00 0	4014586278698	Grinding material Z, Grain 36, No. in pack 10 pcs	12	273
6 99 03 034 00 0	4014586283616	Grinding material Z, Grain 36, No. in pack 10 pcs	12	274
6 99 03 035 00 0	4014586283623	Grinding material Z, Grain 40, No. in pack 10 pcs	12	274
6 99 03 036 00 0	4014586283630	Grinding material Z, Grain 60, No. in pack 10 pcs	12	274
6 99 03 037 00 0	4014586283647	Grinding material Z, Grain 80, No. in pack 10 pcs	12	274
6 99 03 038 00 0	4014586283654	Grinding material Z, Grain 120, No. in pack 10 pcs	12	274
6 99 03 039 00 0	4014586283661	Grinding material R, Grain 24, No. in pack 10 pcs	12	273
6 99 03 040 00 0	4014586283678	Grinding material R, Grain 36, No. in pack 10 pcs	12	273
6 99 03 041 00 0	4014586283685	Grinding material Z, Grain 36, No. in pack 10 pcs	12	274
6 99 03 042 00 0	4014586283692	Grinding material R, Grain 40, No. in pack 10 pcs	12	273
6 99 03 043 00 0	4014586283708	Grinding material Z, Grain 40, No. in pack 10 pcs	12	274
6 99 03 044 00 0	4014586283715	Grinding material R, Grain 60, No. in pack 10 pcs	12	273
6 99 03 045 00 0	4014586283722	Grinding material Z, Grain 60, No. in pack 10 pcs	12	274
6 99 03 046 00 0	4014586283739	Grinding material R, Grain 80, No. in pack 10 pcs	12	273
6 99 03 047 00 0	4014586283746	Grinding material Z, Grain 80, No. in pack 10 pcs	12	274
6 99 03 048 00 0	4014586283753	Grinding material R, Grain 120, No. in pack 10 pcs	12	273
6 99 03 049 00 0	4014586283760	Grinding material Z, Grain 120, No. in pack 10 pcs	12	274
6 99 03 050 00 0	4014586283777	Grinding material A, Grain 220, No. in pack 10 pcs	12	274
6 99 03 051 00 0	4014586283784	Grinding material A, Grain 320, No. in pack 10 pcs	12	274
6 99 03 052 00 0	4014586283791	Grinding material A, Grain 400, No. in pack 10 pcs	12	274
6 99 03 053 00 0	4014586283807	Grinding material R, Grain 36, No. in pack 10 pcs	12	273
6 99 03 054 00 0	4014586283814	Grinding material Z, Grain 36, No. in pack 10 pcs	12	274
6 99 03 097 00 0	4014586292915	Grinding material R, Grain 36, No. in pack 10 pcs	12	-
6 99 03 098 00 0	4014586292922	Grinding material R, Grain 60, No. in pack 10 pcs	12	-
6 99 03 099 00 0	4014586292939	Grinding material R, Grain 80, No. in pack 10 pcs	12	-
6 99 03 111 00 0	4014586299235	Grinding material R, Grain 36, No. in pack 10 pcs	12	273
6 99 03 112 00 0	4014586299242	Grinding material Z, Grain 36, No. in pack 10 pcs	12	274
6 99 03 116 01 0	4014586329888	Fleece belt, Model coarse, No. in pack 3 pcs	12	274
6 99 03 117 01 0	4014586329895	Fleece belt, Model coarse, No. in pack 3 pcs	12	274
6 99 03 118 01 0	4014586329901	Fleece belt, Model medium, No. in pack 3 pcs	12	274
6 99 03 119 01 0	4014586329918	Fleece belt, Model medium, No. in pack 3 pcs	12	274
6 99 03 120 01 0	4014586329925	Fleece belt, Model very fine, No. in pack 3 pcs	12	274
6 99 03 121 01 0	4014586329932	Fleece belt, Model very fine, No. in pack 3 pcs	12	274
6 99 03 122 00 0	4014586368054	Grinding material R, Grain 36, No. in pack 10 pcs	12	273
6 99 03 122 01 0	4014586332369	Fleece strips	12	-
6 99 03 126 00 0	4014586379029	3M™ Cubitron™ II, Grain 36, No. in pack 10 pcs	12	258
6 99 03 127 00 0	4014586379036	3M™ Cubitron™ II, Grain 60, No. in pack 10 pcs	12	258
6 99 03 128 00 0	4014586379043	3M™ Cubitron™ II, Grain 80, No. in pack 10 pcs	12	258
6 99 03 130 00 0	4014586379050	Grinding material Z, Grain 36, No. in pack 10 pcs	12	258

Part number	EAN	Description	PC	Page
6 99 03 131 00 0	4014586379067	Grinding material Z, Grain 60, No. in pack 10 pcs	12	258
6 99 03 132 00 0	4014586379074	Grinding material Z, Grain 80, No. in pack 10 pcs	12	258
6 99 03 133 00 0	4014586379081	Grinding material Z, Grain 120, No. in pack 10 pcs	12	258
6 99 03 134 00 0	4014586379098	Grinding material A, Grain 220, No. in pack 10 pcs	12	258
6 99 03 135 00 0	4014586379104	Grinding material A, Grain 320, No. in pack 10 pcs	12	258
6 99 03 136 00 0	4014586379111	Grinding material A, Grain 420, No. in pack 10 pcs	12	258
6 99 03 137 00 0	4014586379128	Grinding material R, Grain 36, No. in pack 10 pcs	12	258
6 99 03 138 00 0	4014586379135	Grinding material R, Grain 60, No. in pack 10 pcs	12	258
6 99 03 139 00 0	4014586379142	Grinding material R, Grain 80, No. in pack 10 pcs	12	258
6 99 03 140 00 0	4014586379159	Grinding material R, Grain 120, No. in pack 10 pcs	12	258
6 99 03 143 00 0	4014586379173	Fleece belt, Model medium, No. in pack 3 pcs	12	258
6 99 03 149 00 0	4014586385938	3M™ Cubitron™ II, Grain 60, No. in pack 10 pcs	12	273
6 99 03 150 00 0	4014586385945	3M™ Cubitron™ II, Grain 80, No. in pack 10 pcs	12	273
6 99 03 154 00 0	4014586385983	3M™ Cubitron™ II, Grain 36, No. in pack 10 pcs	12	273
6 99 03 155 00 0	4014586385990	3M™ Cubitron™ II, Grain 60, No. in pack 10 pcs	12	273
6 99 03 157 00 0	4014586405063	3M™ Cubitron™ II, Grain 36, No. in pack 10 pcs	12	258
6 99 03 158 00 0	4014586405070	Grinding material R, Grain 36, No. in pack 10 pcs	12	258
6 99 03 159 00 0	4014586405087	Grinding material Z, Grain 36, No. in pack 10 pcs	12	258
9 01 02 012 01 0	4014586876894	Angled head Basic, Tool Holder QuickIN 1/4" Hexagon socket	05	-
9 01 02 013 01 0	4014586876900	Angled head Basic, Tool Holder 3/8" Outer square	05	-
9 01 02 014 01 0	4014586882703	Angled head Basic, Tool Holder 1/4" Outer square	05	-
9 01 02 015 02 0	4014586882802	Angled head up to 45 Nm, Tool Holder 3/8" Outer square	05	59
9 01 02 016 02 0	4014586882826	Angled head up to 60 Nm, Tool Holder 1/2" Outer square	05	59
9 01 02 017 02 0	4014586887784	Angled head up to 18 Nm, Tool Holder 3/8" Outer square	05	59
9 01 02 018 02 0	4014586889290	Angled head up to 14 Nm, Tool Holder 3/8" Outer square	05	58
9 01 02 019 02 0	4014586889306	Angled head up to 14 Nm, Tool Holder 1/4" Outer square	05	58
9 01 02 020 02 0	4014586889313	Angled head up to 14 Nm, Tool Holder 1/4" Hexagon socket	05	59
9 01 02 021 02 0	4014586889320	Angled head up to 14 Nm, Tool Holder QuickIN 1/4" Hexagon socket	05	59
9 01 04 009 01 0	4014586871622	M55 X magazine	01	65
9 01 04 010 01 0	4014586871639	M55 X magazine extension with belt guide	02	65
9 01 05 002 01 8	4014586833682	Safety slipping clutch	02	-
9 01 06 001 02 0	4014586886930	Straight output, Tool Holder QuickIN 1/4" Hexagon socket	05	59
9 01 06 002 02 0	4014586886626	Straight output, Tool Holder 3/8" Outer square	05	59
9 06 04 008 01 3	4014586849805	Protective suction hood	02	90
9 06 04 009 01 7	4014586849829	Protective suction hood	02	90
9 06 06 002 00 9	4014586834467	Saw blade guide	02	144
9 07 02 001 00 1	4014586834498	Clamping fixture	02	144
9 07 02 003 00 8	4014586834511	Clamping fixture	02	144
9 07 02 004 00 6	4014586834528	Clamping fixture	02	144
9 07 02 005 00 0	4014586839783	FEIN clamp and feed device	02	144
9 12 01 002 00 4	4014586842868	Compressed air cooling lubrication	08	-
9 26 01 022 01 3	4014586846965	Vacuum pump	02	163
9 26 01 023 02 3	4014586847283	Compressor	08	-
9 26 02 054 01 6	4014586841342	Suction plate	02	163
9 26 02 055 01 0	4014586841335	Pipe drilling device	02	163
9 26 02 057 01 7	4014586843322	Vacuum plate	02	163
9 26 02 071 01 9	4014586851389	Profile set 160	01	134
9 26 02 074 01 4	4014586855080	Dust extraction set	04	244
9 26 02 075 01 8	4014586855097	Device for dust extract	04	244
9 26 02 079 01 0	4014586857152	Size 2 tapping quick-change chuck with QuickIN fitting	02	185
9 26 02 082 01 0	4014586861920	Size 3 tapping quick-change chuck with QuickIN MAX/Weldon 32 fitting	02	185
9 26 02 083 01 0	4014586860152	Table-top and drill jigs support	04	238
9 26 02 085 01 0	4014586867977	Vacuum plate	02	-
9 26 02 089 01 0	4014586878508	Size 2 tapping quick-change chuck with 3/4" Weldon fitting	02	185
9 26 02 091 00 0	4014586882932	Dust extraction set	04	238
9 26 02 092 00 0	4014586882949	Dust extraction set	04	238
9 26 02 095 00 0	4014586885551	Dust extraction set	04	238
9 26 02 101 01 0	4014586889771	Drilling dust nozzle	02	31
9 26 02 102 00 0	4014586892283	Dust extraction set	04	238
9 26 04 096 01 0	4014586863986	Quick charger ALG 30	02	-
9 26 04 096 03 0	4014586887128	Quick charger ALG 30, No. in pack 25 pcs	02	-
9 26 04 103 01 0	4014586862651	Charging adapter	02	-

Part number	EAN	Description	PC	Page
9 26 04 163 02 0	4014586872681	Programming adapter	02	59
9 26 04 170 02 0	4014586882727	Battery pack, Current/Voltages 14.4 V, Capacity 2.5 Ah	02	-
9 26 04 170 03 0	4014586885148	Battery pack, Current/Voltages 14.4 V, Capacity 2.5 Ah, No. in pack 15 pcs	02	-
9 26 04 172 02 0	4014586882741	Battery pack, Current/Voltages 14.4 V, Capacity 5 Ah	02	-
9 26 04 172 03 0	4014586885162	Battery pack, Current/Voltages 14.4 V, Capacity 5 Ah, No. in pack 15 pcs	02	-
9 26 04 175 02 0	4014586890586	Battery pack, Current/Voltages 18 V, Capacity 6 Ah	02	120
9 26 04 175 03 0	4014586890593	Battery pack, Current/Voltages 18 V, Capacity 6 Ah, No. in pack 12 pcs	02	58
9 26 04 179 02 0	4014586888224	HighPower battery pack, Current/Voltages 18 V, Capacity 5.2 Ah	02	148
9 26 04 180 01 0	4014586890630	Quick charger ALG 80	02	239
9 26 04 180 02 0	4014586892047	Quick charger ALG 80, No. in pack 25 pcs	02	58
9 26 04 182 02 0	4014586890609	Battery pack, Current/Voltages 18 V, Capacity 3 Ah	02	120
9 26 04 182 03 0	4014586890616	Battery pack, Current/Voltages 18 V, Capacity 3 Ah, No. in pack 12 pcs	02	58
9 26 04 183 02 0	4014586891262	Battery pack, Current/Voltages 12 V, Capacity 3 Ah	02	239
9 26 04 184 02 0	4014586890623	Battery pack, Current/Voltages 12 V, Capacity 6 Ah	02	239
9 26 04 189 02 0	4014586892054	Quick charger ALG 80, No. in pack 25 pcs	02	-
9 26 04 200 02 0	4014586882819	Cordless ALED 12-18 V LED lamp	02	120
9 26 04 201 02 0	4014586891439	AUSB 12-18 V cordless USB adapter	02	120
9 26 04 210 01 0	4014586893921	Quick charger ALG 80 BC	02	120
9 26 04 323 01 0	4014586892788	Battery starter set, Current/Voltages 18 V, Capacity 6 Ah	02	121
9 26 04 324 01 0	4014586892849	Battery starter set, Current/Voltages 18 V, Capacity 3 Ah	02	121
9 26 04 325 01 0	4014586892900	HighPower battery starter set, Current/Voltages 18 V, Capacity 5.2 Ah	02	148
9 26 04 326 01 0	4014586892542	Battery starter set, Current/Voltages 12 V, Capacity 3 Ah	02	239
9 26 04 327 01 0	4014586892603	Battery starter set, Current/Voltages 12 V, Capacity 6 Ah	02	239
9 90 01 010 00 1	4014586871417	Machine base GX/GIS	13	-

Part number	Sound pressure level LpA (dB)	Uncertainty of measured value KpA (dB)	Sound power level LWA (dB)	Uncertainty of measured value KWA (dB)	Sound peak value LpCpeak (dB)	Uncertainty of meas- ured value KpCpeak (dB)	Vibration value 1 ahv 3-way (m/s ²)	Uncertainty of measured value Ka (m/s ²)	Vibration value 2 ahv 3-way (m/s ²)
7 105 03 62 00 0	75	3	86	3	91	3	2,5	1,5	
7 105 04 62 00 0	75	3	86	3	89	3	1,8	1,5	
7 112 62 60 00 0	81,0	3	92,0	3	95,0	3	<1,8	1,5	
7 112 63 60 00 0	81,0	3	92,0	3	95,0	3	<1,8	1,5	
7 112 64 60 00 0	81,0	3	92,0	3	95,0	3	<1,8	1,5	
7 112 66 60 00 0	81,0	3	92,0	3	95,0	3	<1,8	1,5	
7 112 70 60 00 0	81,0	3	92,0	3	95,0	3	<1,8	1,5	
7 113 11 63 00 0	73	3	84	3	92	3	1	1,5	
7 113 16 64 00 0	74	3	85	3	87	3	1,5	1,5	
7 113 16 65 00 0	74	3	85	3	87	3	1,5	1,5	
7 113 20 64 00 0	65,5	3	76,6	3	78,4	3	1	1,5	
7 113 21 64 00 0	65,9	3	76,9	3	78,9	3			
7 113 22 64 00 0	76	3	87	3	89	3	ah,D 1,5	1,5	ah 0,6
7 113 23 64 00 0	91	3	102	3	107	3	ah,D 1,5	1,5	ah 0,5
7 115 03 64 00 0	93,8	3	104,8	3	112	3	14,5	1,5	
7 115 04 64 00 0	90,5	3	101,2	3	113,7	3	ah 9,1	1,5	
7 115 05 64 00 0	91,5	3	102,5	3	111,7	3	ah 9,7	1,5	
7 115 06 64 00 0	96,1	3	107,1	3	118,2	3	ah 16,1	1,5	
7 115 07 64 00 0	93,8	3	104,8	3	114,5	3	ah 12,9	1,5	
7 115 08 64 00 0	93,6 dB	3 dB	104,6 dB	3 dB	119,5 dB	3 dB	12,9 m/s ²	1,5 m/s ²	
7 116 10 64 00 0	75,5	3	86,5	3	90,6	3	1	1,5	
7 116 11 64 00 0	73	3	84	3	86	3	ah,D 1,5	1,5	
7 120 01 62 00 0	86	3	97	3	101	3	ah,AG 5,0	1,5	ah,DS 1,8
7 120 02 62 00 0	86	3	97	3	101	3	ah,AG 5,0	1,5	ah,DS 1,8
7 120 03 62 00 0	86	3	97	3	101	3	ah,AG 5,0	1,5	ah,DS 1,8
7 120 04 62 00 0	86	3	97	3	101	3	ah,AG 5,0	ah,DS 1,8	
7 123 01 62 00 0	84	3	95	3	98	3	ah,SG (Ø 50 mm) 12,0	1,5	ah,SG (Ø 25 mm) 5,0
7 123 02 62 00 0	85	3	96	3	98	3	ah,SG (Ø 50 mm) 12,0	1,5	ah,SG (Ø 25 mm) 5,0
7 123 03 62 00 0	85	3	96	3	98	3	ah,SG50 2,0	1,5	ah,SG25 1,0
7 129 32 61 00 0	70	3	81	3	83	3			
7 129 32 62 00 0	70	3	81	3	83	3			
7 129 33 61 00 0	74	3	85	3	87	3			
7 129 33 62 00 0	74	3	85	3	87	3			
7 129 34 61 00 0	83	3	94	3	97	3			
7 129 34 62 00 0	83	3	94	3	97	3			
7 129 35 61 00 0	83	3	94	3	97	3			
7 129 35 62 00 0	83	3	94	3	97	3			
7 130 03 61 00 0	74,8	3	85,8	3	87,9	3	ah 10,1	1,5	
7 130 04 61 00 0	74,6	3	85,6	3	87,9	3	ah 3,3	1,5	
7 132 04 61 00 0	74	3	85	3	86	3	ah 6,5	1,5	
7 132 05 61 00 0	74	3	85	3	85	3	ah 4,7	1,5	
7 132 06 61 00 0	74	3	85	3	85	3	ah 4,7	1,5	
7 138 01 61 00 0	85	3	96	3	100	3	ah, 4,0	1,5	ah, 4,6
7 140 01 64 00 0	88,4	3	99,4	3	105,8	3	ah,D 4,2	1,5	ah,D 11,8
7 170 01 62 00 0	82,4	3	93,4	3	97,1	3	ah,D 0,6	1,5	
7 170 02 62 00 0	82,4	3	93,4	3	97,1	3	ah,D 0,6	1,5	
7 202 51 60 00 0	79,1	3	90,1	3	93,4	3	1,1	1,5	
7 205 47 60 00 0	81,1	3	92,1	3	95,2	3	ah,D 2,4	1,5	
7 205 49 60 00 0	82,1	3	93,1	3	95,6	3	ah,D 1,9	1,5	
7 205 51 60 00 0	82	3	93	3	96	3	3	1,5	
7 205 52 60 00 0	82	3	93	3	96	3	ah,D 4,0	1,5	
7 205 52 61 00 0	82	3	93	3	96	3	ah,D 4,0	1,5	
7 205 53 60 00 0	82	3	93	3	96	3	ah,D 3,0	1,5	
7 205 53 61 00 0	82	3	93	3	96	3	ah,D 3,0	1,5	
7 205 54 60 00 0	82	3	93	3	96	3	ah,D 3,0	1,5	
7 205 54 61 00 0	82	3	93	3	96	3	ah,D 3,0	1,5	
7 205 55 60 00 0	82	3	93	3	96	3	ah,D 3,0	1,5	
7 205 55 61 00 0	82	3	93	3	96	3	ah,D 3,0	1,5	
7 209 38 60 00 0	82	3	93	3	96	3	3,0	1,5	

Part number	Sound pressure level LpA (dB)	Uncertainty of measured value KpA (dB)	Sound power level LWA (dB)	Uncertainty of measured value KWA (dB)	Sound peak value LpCpeak (dB)	Uncertainty of meas- ured value KpCpeak (dB)	Vibration value 1 ahv 3-way (m/s ²)	Uncertainty of measured value Ka (m/s ²)	Vibration value 2 ahv 3-way (m/s ²)
7 213 04 00 23 9	82	3	93	3	96	3	1	1,5	
7 213 06 50 01 8	81	3	92	3	98	3	0,8	1,5	
7 213 13 00 23 0	81	3	92	3	98	3	0,8	1,5	
7 221 05 00 23 7	87	3	98	3	103	3	ah,AG 6,0	1,5	ah,SG 2,5
7 221 05 29 23 2	87	3	98	3	103	3	ah,AG 6,0	1,5	ah,SG 2,5
7 221 06 00 23 0	87	3	98	3	103	3	ah,AG 6,0	1,5	ah,SG 2,5
7 221 06 29 23 5	87	3	98	3	103	3	ah,AG 6,0	1,5	ah,SG 2,5
7 221 07 00 23 6	87	3	98	3	103	3	ah,AG 6,0	1,5	ah,SG 2,5
7 221 08 00 23 2	87	3	98	3	103	3	ah,AG 6,0	1,5	ah,SG 2,5
7 221 08 29 23 7	87	3	98	3	103	3	ah,AG 6,0	1,5	ah,SG 2,5
7 221 10 00 23 3	87	3	98	3	103	3	ah,AG 6,0	1,5	ah,DS 2,5
7 221 10 29 23 8	87	3	98	3	103	3	ah,AG 6,0	1,5	ah,DS 2,5
7 221 11 00 23 2	87	3	98	3	103	3	ah,AG 6,0	1,5	ah,DS 2,5
7 221 11 29 23 7	87	3	98	3	103	3	ah,AG 6,0	1,5	ah,DS 2,5
7 221 26 00 23 0	87	3	98	3	103	3	ah,AG 6,0	1,5	ah,SG 2,5
7 221 26 29 23 0	87	3	98	3	103	3	ah,AG 6,0	1,5	ah,SG 2,5
7 221 27 00 23 0	87	3	98	3	103	3	ah,AG 6,0	1,5	ah,SG 2,5
7 221 27 29 23 0	87	3	98	3	103	3	ah,AG 6,0	1,5	ah,SG 2,5
7 221 31 00 23 0	87	3	98	3		3	ah,AG 3,8	1,5	
7 221 48 00 23 0	84	3	95	3	100	3	ah,P 2,5	1,5	ah,SG 2,5
7 221 48 50 01 0	84	3	95	3	100	3	ah,P 2,5	1,5	ah,SG 2,5
7 221 48 51 01 0	84	3	95	3	100	3	ah,P 2,5	1,5	ah,SG 2,5
7 221 48 60 00 0	84	3	95	3	100	3	ah,P 2,5	1,5	ah,SG 2,5
7 221 49 00 23 0	84	3	95	3	100	3	ah,P 3,5	1,5	ah,SG 2,5
7 221 49 50 01 0	84	3	95	3	100	3	ah,P 3,5	1,5	ah,SG 2,5
7 221 49 51 01 0	84	3	95	3	100	3	ah,P 3,5	1,5	ah,SG 2,5
7 221 63 00 23 0	84	3	95	3	100	3	ah,P 3,5	1,5	ah,SG 2,5
7 221 63 51 01 0	84	3	95	3	100	3	ah,P 3,5	1,5	ah,SG 2,5
7 221 67 60 00 0	85	3	96	3	101	3	ah,P/T=3 2,5	1,5	ah,P/T=6 5,0
7 221 73 60 00 0	90	3	101	3	105	3	ah,AG 5,0	1,5	ah,DS 1,8
7 221 74 60 00 0	90	3	101	3	105	3	ah,AG 5,0	1,5	ah,SG 1,8
7 221 75 60 00 0	89	3	100	3	104	3	ah,AG 5,0	1,5	ah,SG 2,0
7 221 76 60 00 0	89	3	100	3	104	3	ah,AG 5,0	1,5	ah,SG 2,0
7 221 77 60 00 0	90	3	101	3	105	3	ah,AG 6,0	1,5	ah,SG 1,8
7 221 78 60 00 0	90	3	101	3	105	3	ah,AG 5,0	1,5	ah,SG 3,5
7 221 79 60 00 0	90	3	101	3	105	3	ah,AG 5,0	1,5	ah,SG 3,5
7 221 87 60 00 0	90	3	101	3	105	3	7,9	1,5	1,5
7 221 90 60 00 0	90	3	101	3	105	3	5,9	1,5	2,1
7 221 91 60 00 0	90	3	101	3	105	3	5,9	1,5	2,1
7 221 98 60 00 0	91	3	102	3	105	3	ah,AG 6,5	1,5	ah,DS 3,5
7 222 07 60 00 0	90	3	101	3	105	3	5,0	1,5	3,5
7 222 08 60 00 0	90	3	101	3	105	3	5,0	1,5	3,5
7 222 09 60 00 0	90	3	101	3	105	3	5,0	1,5	3,5
7 222 10 60 00 0	90	3	101	3	105	3	5,0	1,5	3,5
7 222 11 60 00 0	90	3	101	3	105	3	5,0	1,5	3,5
7 222 12 60 00 0	90	3	101	3	105	3	5,0	1,5	3,5
7 222 13 60 00 0	90	3	101	3	105	3	4,1	1,5	2,2
7 222 13 61 00 0	90	3	101	3	105	3	4,1	1,5	2,2
7 222 18 60 00 0	90	3	101	3	105	3	5,9	1,5	2,1
7 222 19 60 00 0	90	3	101	3	105	3	5,9	1,5	2,1
7 222 20 60 00 0	90	3	101	3	105	3	5,0	1,5	1,6
7 222 21 60 00 0	90	3	101	3	105	3	5,0	1,5	1,6
7 222 22 60 00 0	90	3	101	3	105	3	3,4	1,5	1,6
7 222 23 60 00 0	90	3	101	3	105	3	3,4	1,5	1,6
7 223 16 60 00 0	84	3	95	3	97	3	4,7	1,5	
7 223 17 60 00 0	84	3	95	3	97	3	4,7	1,5	7,9
7 223 19 60 00 0	84	3	95	3	97	3	5,3	1,5	11,4
7 223 20 60 00 0	84	3	95	3	97	3	1,9	1,5	2,9
7 223 22 60 00 0	85	3	96	3	98	3	9,7	1,5	

Part number	Sound pressure level LpA (dB)	Uncertainty of measured value KpA (dB)	Sound power level LWA (dB)	Uncertainty of measured value KWA (dB)	Sound peak value LpCpeak (dB)	Uncertainty of meas- ured value KpCpeak (dB)	Vibration value 1 ahv 3-way (m/s ²)	Uncertainty of measured value Ka (m/s ²)	Vibration value 2 ahv 3-way (m/s ²)
7 223 23 60 00 0	85	3	96	3	98	3	1,5	1,5	4,5
7 223 24 60 00 0	83	3	94	3	95	3	4,8	1,5	
7 223 25 60 00 0	83	3	94	3	95	3	1,0	1,5	
7 228 05 50 00 0	84	3	95	3	99	3	2	1,5	
7 228 05 51 00 0	84	3	95	3	99	3	2		
7 229 67 61 00 0	72	3	83	3	84	3			
7 229 67 62 00 0	72	3	83	3	84	3			
7 229 68 61 00 0	85	3	96	3	97	3			
7 229 68 62 00 0	85	3	96	3	97	3			
7 229 69 61 00 0	82	3	93	3	96	3			
7 229 70 61 00 0	82	3	93	3	96	3			
7 229 70 62 00 0	85	3	96	3	97	3			
7 229 70 63 00 0	85,0	3	96,0	3	97,0	3			
7 229 72 61 00 0	74	3	85	3	96	3			
7 230 31 61 00 0	81,1	3	92,1	3	93,3	3	5,7	1,5	
7 230 32 61 00 0	81,1	3	92,1	3	93,3	3	5,7	1,5	
7 230 33 61 00 0	76,2	3	87,2	3	91	3	10,8	1,5	
7 230 34 61 00 0	82,5	3	93,5	3	94,9	3	4,1	1,5	
7 230 35 61 00 0	81,7	3	92,7	3	93,8	3	4,8	1,5	
7 232 30 00 23 0	85	3	96	3	100	3	8,9	1,5	
7 232 31 00 23 9	85	3	96	3	100	3	10	1,5	
7 232 38 60 00 0	82	3	93	3	93	3	8,8	1,5	
7 232 39 60 00 0	82	3	93	3	93	3	8,8	1,5	
7 232 40 60 00 0	80	3	91	3	91	3	7,3	1,5	
7 232 41 60 00 0	82	3	93	3	93	3	9,5	1,5	
7 232 42 60 00 0	82	3	93	3	93	3	6,8	1,5	
7 234 15 00 23 0	79	3	90	3	94	3	7,8	1,5	
7 234 17 00 23 9	79	3	90	3	94	3	7,8	1,5	
7 234 22 00 23 0	89	3	100	3	102	3	7	1,5	
7 234 23 00 23 0	89	3	100	3	102	3	7	1,5	
7 236 54 60 00 0	95,3	3	106,3	3	110,9	3	ah = 2,7	1,5	
7 238 16 61 00 0	90	3	101	3	104	3	ah, 5,4	1,5	ah, 6,2
7 238 18 61 00 0	90	3	101	3	104	3	ah, 3,7	1,5	ah, 4,3
7 245 01 60 00 0	93,1	3,0	104,1	3,0	107,4	3,0			
7 245 02 60 00 0	92,9	3,0	103,9	3,0	107,2	3,0			
7 270 40 61 00 0	82,4	3	93,4	3	97	3	< 2,5	1,5	
7 270 41 61 00 0	82,4	3	93,4	3	97	3	< 2,5	1,5	
7 270 42 61 00 0	82,4 dB	3 dB	93,4 dB	3 dB	97 dB	3 dB	< 2,5 m/s ²	1,5 m/s ²	
7 270 43 61 00 0	82,4	3	93,4	3	97	3	< 2,5	1,5	
7 270 50 60 00 0	87,5	3	98,5	3	102,3	3	ah,D <2,5	1,5	
7 270 51 60 00 0	88,5	3	99,5	3	102,5	3	ah,D <2,5	1,5	
7 270 53 61 00 0	86,7	3	97,7	3	101,2	3	ah,D <2,5	1,5	
7 270 54 61 00 0	86,7	3	97,7	3	101,2	3	ah,D <2,5	1,5	
7 270 55 61 00 0	86,7	3	97,7	3	101,2	3	ah,D <2,5	1,5	
7 270 56 61 00 0	86,	3	97,7	3	101,2	3	ah,D <2,5	1,5	
7 270 57 61 00 0	85,6	3	96,6	3	98,9	3	ah,D <2,5	1,5	
7 270 58 61 00 0	85,6	3	96,6	3	98,9	3	ah,D <2,5	1,5	
7 270 60 61 00 0	84,0	3	95,0	3	98,7	3	ah,D = 1,4	1,5	
7 270 65 60 00 0	83	3	94	3	98	3	ah,D <2,5	1,5	
7 270 71 61 00 0	86,7	3	97,7	3	101,2	3	<2,5	1,5	
7 270 72 61 00 0	86,7	3	97,7	3	101,2	3	<2,5	1,5	
7 272 03 61 00 0	87	3	98	3	99	3		1,5	
7 534 08 00 00 0	81	3	92	3	102	3	ah,D 7,1	1,5	
7 536 03 00 01 0	82	3	93	3		3			
7 820 62 00 22 0	83	3	94	3	100	3	3,9	1,5	
7 820 62 00 26 0	83	3	94	3	100	3	3,9	1,5	
7 820 63 00 12 0	83	3	94	3	100	3	3,9	1,5	
7 820 63 00 20 0	83	3	94	3	100	3	3,9	1,5	
7 820 64 00 12 0	84	3	95	3	100	3	3,9	1,5	

Part number	Sound pressure level LpA (dB)	Uncertainty of measured value KpA (dB)	Sound power level LWA (dB)	Uncertainty of measured value KWA (dB)	Sound peak value LpCpeak (dB)	Uncertainty of meas- ured value KpCpeak (dB)	Vibration value 1 ahv 3-way (m/s ²)	Uncertainty of measured value Ka (m/s ²)	Vibration value 2 ahv 3-way (m/s ²)
7 820 64 00 17 0	84	3	95	3	100	3	3,9	1,5	
7 820 64 00 20 0	84	3	95	3	100	3	3,9	1,5	
7 820 65 00 22 0	84	3	95	3	100	3	3,9	1,5	
7 820 65 00 26 0	84	3	95	3	100	3	3,9	1,5	
7 820 70 00 20 0	81	3	92	3	95	3	4,3	1,5	
7 820 71 00 26 0	81	3	92	3	95	3	4,3	1,5	
7 820 72 00 20 0	81	3	92	3	95	3	4,6	1,5	
7 820 73 00 26 0	81	3	92	3	95	3	4,6	1,5	
7 820 74 00 20 0	85	3	96,0	3	100,00	3	3,8	1,5	
7 820 75 00 26 0	85	3	96	3	100	3	3,8	1,5	
7 820 77 00 26 0	85	3	96	3	100	3	4,7	1,5	
7 820 79 00 20 0	92,0	3	81,0	3	100,00	3	4,3	1,5	
7 820 80 00 26 0	81	3	92	3	100	3	4,3	1,5	
7 820 82 00 12 0	83	3	94	3	97	3	3,6	1,5	
7 820 82 00 17 0	83	3	94	3	97	3	3,6	1,5	
7 820 82 00 20 0	83	3	94	3	97	3	3,6	1,5	
7 820 83 00 22 0	83	3	94	3	97	3	3,6	1,5	
7 820 83 00 26 0	83	3	94	3	97	3	3,6	1,5	
7 820 85 00 26 0	81	3	92	3	95	3	4,5	1,5	
7 820 86 60 00 0	74	3	85	3	90	3	ah,AG 2,8	1,5	ah,SG 1,0
7 823 03 00 26 0	71	3	82	3	85	3	3,7	1,5	
7 823 19 00 26 0	79	3	90	3	92	3	5	1,5	
7 823 20 00 26 0	77	3	88	3	92	3	5,5	1,5	
7 824 37 00 26 0	83	3	94	3	101	3	2	1,5	
7 824 39 00 12 0	84	3	95	3	103	3	Ø 125 mm = 7,5 Ø 100 mm = 3,3	1,5	
7 824 39 00 17 0	84	3	95	3	103	3	Ø 125 mm = 7,5 Ø 100 mm = 3,3	1,5	
7 824 39 00 20 0	84	3	95	3	103	3	Ø 125 mm = 7,5 Ø 100 mm = 3,3	1,5	
7 824 39 00 22 0	84	3	95	3	103	3	Ø 125 mm = 7,5 Ø 100 mm = 3,3	1,5	
7 824 39 00 26 0	84	3	95	3	103	3	Ø 125 mm = 7,5 Ø 100 mm = 3,3	1,5	
7 824 40 00 26 0	84	3	95	3	97	3	Ø 125 mm = 2,0	1,5	
7 824 41 00 20 0	84	3	95	3	97	3	Ø 80 mm = 11,8 Ø 50 mm = 6,3	1,5	
7 824 42 00 22 0	83	3	94	3	97	3	ah,SG (Ø 80 mm) 11,8	1,5	ah,SG (Ø 50 mm) 6,3
7 824 42 00 26 0	83	3	94	3	97	3	ah,SG (Ø 80 mm) 11,8	1,5	ah,SG (Ø 50 mm) 6,3
9 20 29 060 00 0	67,0	3	81,0	3			<2,5		1,5
9 20 30 060 00 0	67	2	81	2			< 2,5		
9 20 31 060 00 0	67	2	81	2			< 2,5		
9 20 32 060 00 0	67	2	81	2			< 2,5		

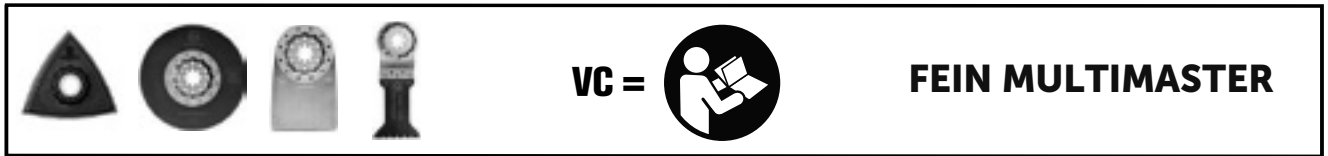

	AMM 300 PLUS VC	AMM 500 PLUS VC	MM 300 PLUS VC	MM 500 PLUS VC
6 35 02 097 ...	0	0	2	0
6 35 02 106 ...	0	0	2	0
6 35 02 113 ...	0	0	2	0
6 35 02 114 ...	0	0	1	0
6 35 02 118 ...	0	0	2	0
6 35 02 125 ...	0	0	1	0
6 35 02 126 ...	1	1	4	1
6 35 02 127 ...	1	1	5	1
6 35 02 133 ...	1	1	4	1
6 35 02 134 ...	1	1	5	1
6 35 02 151 ...	1	1	4	1
6 35 02 152 ...	1	1	5	1
6 35 02 157 ...	1	1	3	0
6 35 02 160 ...	1	1	4	1
6 35 02 161 ...	1	1	5	1
6 35 02 166 ...	1	1	2	0
6 35 02 169 ...	1	1	3	0
6 35 02 170 ...	1	1	3	0
6 35 02 174 ...	0	0	3	0
6 35 02 175 ...	1	1	3	0
6 35 02 176 ...	1	1	3	0
6 35 02 183 ...	1	1	4	1
6 35 02 184 ...	0	0	3	0
6 35 02 187 ...	1	1	3	0
6 35 02 188 ...	1	1	2	0
6 35 02 191 ...	1	1	4	1
6 35 02 193 ...	1	1	4	1
6 35 02 196 ...	1	1	3	0
6 35 02 198 ...	1	1	4	1
6 35 02 199 ...	1	1	5	1
6 35 02 205 ...	1	1	4	1
6 35 02 206 ...	1	1	4	1
6 35 02 207 ...	1	1	5	1
6 35 02 208 ...	1	1	5	1
6 35 02 214 ...	1	1	3	0
6 35 02 216 ...	0	0	2	0
6 35 02 217 ...	1	1	2	0
6 35 02 219 ...	1	1	3	0
6 35 02 221 ...	1	1	5	1
6 35 02 222 ...	1	1	4	1
6 35 02 223 ...	1	1	4	1
6 35 02 225 ...	1	1	4	1
6 35 02 226 ...	1	1	4	1
6 35 02 227 ...	1	1	5	1
6 35 02 228 ...	1	1	5	1
6 35 02 229 ...	1	1	5	1
6 35 02 230 ...	1	1	5	1
6 35 02 231 ...	1	1	5	1
6 35 02 232 ...	1	1	4	1
6 35 02 233 ...	1	1	4	1
6 35 02 236 ...	1	1	4	1
6 35 02 237 ...	1	1	5	1

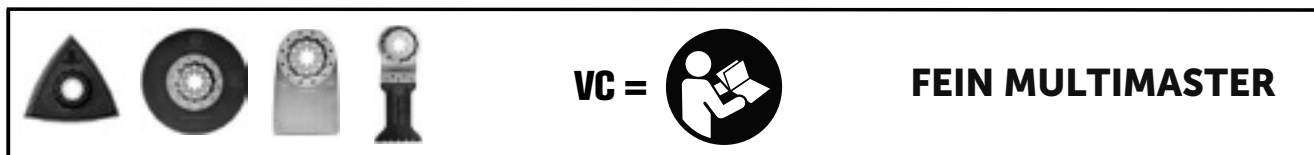

	AMM 300 PLUS VC	AMM 500 PLUS VC	MM 300 PLUS VC	MM 500 PLUS VC
6 37 06 019 ...	0	0	3	0
6 37 19 011 ...	1	1	4	1
6 37 31 001 ...	1	0	2	0
6 37 31 002 ...	1	0	1	0
6 38 06 129 ...	0	0	1	0
6 38 06 136 ...	0	0	1	0
6 38 06 140 ...	0	0	1	0
6 38 06 141 ...	0	0	1	0
6 38 06 142 ...	0	0	1	0
6 38 06 159 ...	0	0	1	0
6 38 06 195 ...	1	3	3	1
6 38 06 204 ...	1	3	3	1
6 38 10 031 ...	2	3	5	1
6 39 03 165 ...	0	0	3	0
6 39 03 200 ...	0	0	2	0
6 39 03 201 ...	0	0	2	0
6 39 03 202 ...	0	0	2	0
6 39 03 226 ...	1	1	4	1
6 39 03 233 ...	0	0	2	0
6 39 03 234 ...	1	2	4	1
6 39 03 235 ...	1	1	3	0
6 39 03 245 ...	0	0	3	0
6 39 03 251 ...	0	1	2	0

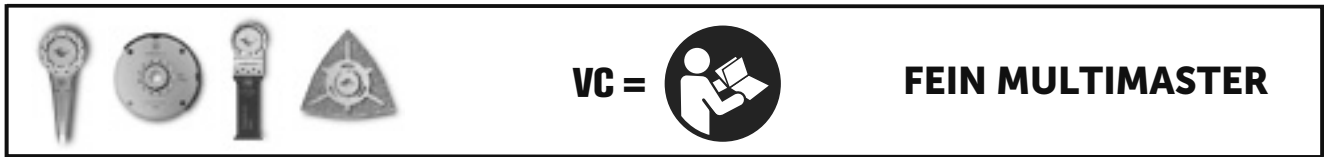

	MM 700 MAX VC	AMM 700 MAX VC		MM 700 MAX VC	AMM 700 MAX VC
6 35 02 097 ...	0	0	6 35 02 224 ...	1	2
6 35 02 106 ...	0	0	6 35 02 225 ...	1	1
6 35 02 113 ...	0	0	6 35 02 226 ...	1	1
6 35 02 114 ...	0	0	6 35 02 227 ...	1	2
6 35 02 118 ...	0	0	6 35 02 228 ...	1	2
6 35 02 125 ...	0	0	6 35 02 229 ...	1	2
6 35 02 126 ...	1	1	6 35 02 230 ...	1	2
6 35 02 127 ...	1	2	6 35 02 231 ...	1	2
6 35 02 133 ...	1	1	6 35 02 232 ...	1	1
6 35 02 134 ...	1	2	6 35 02 233 ...	1	1
6 35 02 151 ...	1	1	6 35 02 236 ...	1	1
6 35 02 152 ...	1	1	6 35 02 237 ...	1	1
6 35 02 157 ...	1	1	6 35 02 238 ...	1	2
6 35 02 160 ...	1	1	6 37 06 019 ...	0	0
6 35 02 161 ...	1	2	6 37 19 011 ...	1	1
6 35 02 166 ...	0	1	6 37 31 001 ...	0	0
6 35 02 169 ...	0	1	6 37 31 002 ...	0	0
6 35 02 170 ...	0	1	6 37 31 006 ...	1	1
6 35 02 174 ...	0	0	6 38 06 129 ...	0	0
6 35 02 175 ...	0	1	6 38 06 136 ...	0	0
6 35 02 176 ...	0	1	6 38 06 140 ...	0	0
6 35 02 183 ...	1	1	6 38 06 141 ...	0	0
6 35 02 184 ...	0	0	6 38 06 142 ...	0	0
6 35 02 187 ...	0	1	6 38 06 159 ...	0	0
6 35 02 188 ...	0	1	6 38 06 195 ...	0	2
6 35 02 191 ...	1	1	6 38 06 204 ...	0	2
6 35 02 193 ...	1	1	6 38 10 031 ...	1	3
6 35 02 196 ...	1	1	6 39 03 165 ...	0	0
6 35 02 198 ...	1	1	6 39 03 200 ...	0	0
6 35 02 199 ...	1	1	6 39 03 201 ...	0	0
6 35 02 200 ...	1	2	6 39 03 202 ...	0	0
6 35 02 201 ...	1	2	6 39 03 226 ...	1	1
6 35 02 202 ...	1	2	6 39 03 233 ...	0	0
6 35 02 203 ...	1	2	6 39 03 234 ...	1	2
6 35 02 204 ...	1	1	6 39 03 235 ...	0	1
6 35 02 205 ...	1	1	6 39 03 236 ...	2	2
6 35 02 206 ...	1	1	6 39 03 237 ...	1	1
6 35 02 207 ...	1	1	6 39 03 238 ...	1	1
6 35 02 208 ...	1	2	6 39 03 239 ...	2	2
6 35 02 213 ...	0	1	6 39 03 240 ...	1	1
6 35 02 214 ...	0	1	6 39 03 241 ...	1	1
6 35 02 215 ...	0	1	6 39 03 242 ...	1	1
6 35 02 216 ...	0	0	6 39 03 243 ...	1	1
6 35 02 217 ...	0	1	6 39 03 244 ...	1	1
6 35 02 218 ...	0	1	6 39 03 245 ...	0	0
6 35 02 219 ...	0	1	6 39 03 246 ...	3	3
6 35 02 220 ...	0	1	6 39 03 247 ...	3	3
6 35 02 221 ...	1	1	6 39 03 248 ...	3	3
6 35 02 222 ...	1	1	6 39 03 251 ...	0	0
6 35 02 223 ...	1	1			

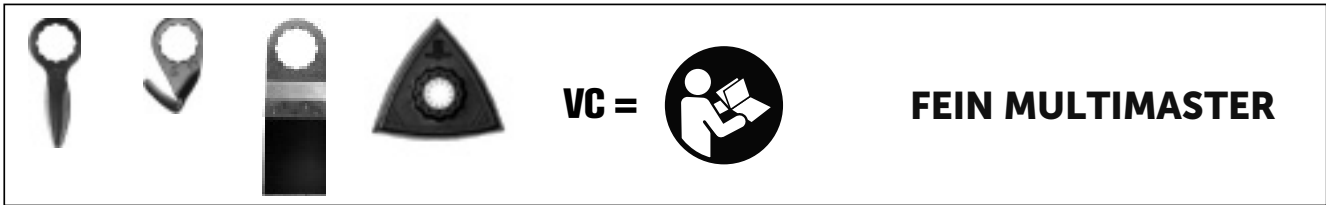

	MM 700-1.7 MM 700-1.7Q	AMM 700-1.7Q		MM 700-1.7 MM 700-1.7Q	AMM 700-1.7Q		MM 700-1.7 MM 700-1.7Q	AMM 700-1.7Q
	VC	VC		VC	VC		VC	VC
6 35 02 102 ...	0	0	6 38 06 140 ...	0	1	6 39 03 154 ...	1	1
6 35 02 103 ...	0	1	6 38 06 141 ...	0	1	6 39 03 155 ...	1	1
6 35 02 115 ...	0	1	6 38 06 195 ...	0	1	6 39 03 156 ...	1	1
6 35 02 116 ...	0	1	6 38 06 204 ...	0	1	6 39 03 157 ...	1	1
6 35 02 119 ...	1	0	6 39 03 072 ...	1	0	6 39 03 160 ...	2	2
6 35 02 120 ...	1	1	6 39 03 073 ...	1	0	6 39 03 161 ...	1	1
6 35 02 121 ...	1	1	6 39 03 076 ...	1	0	6 39 03 162 ...	1	1
6 35 02 122 ...	1	1	6 39 03 079 ...	1	0	6 39 03 163 ...	1	0
6 35 02 123 ...	1	1	6 39 03 081 ...	2	2	6 39 03 166 ...	1	1
6 35 02 124 ...	1	1	6 39 03 082 ...	1	1	6 39 03 168 ...	2	2
6 35 02 135 ...	1	1	6 39 03 083 ...	1	0	6 39 03 169 ...	2	2
6 35 02 136 ...	1	1	6 39 03 087 ...	1	0	6 39 03 170 ...	2	2
6 35 02 138 ...	1	1	6 39 03 095 ...	1	0	6 39 03 171 ...	2	2
6 35 02 147 ...	1	1	6 39 03 097 ...	1	1	6 39 03 172 ...	1	0
6 35 02 148 ...	1	1	6 39 03 099 ...	2	2	6 39 03 173 ...	1	0
6 35 02 155 ...	0	1	6 39 03 101 ...	1	1	6 39 03 174 ...	1	1
6 35 02 158 ...	0	0	6 39 03 103 ...	1	0	6 39 03 176 ...	1	1
6 35 02 162 ...	1	1	6 39 03 104 ...	1	0	6 39 03 179 ...	2	2
6 35 02 163 ...	1	1	6 39 03 105 ...	1	1	6 39 03 181 ...	1	1
6 35 02 164 ...	1	1	6 39 03 107 ...	1	1	6 39 03 182 ...	3	3
6 35 02 165 ...	1	1	6 39 03 108 ...	1	0	6 39 03 183 ...	1	0
6 35 02 167 ...	0	1	6 39 03 109 ...	1	0	6 39 03 184 ...	1	0
6 35 02 168 ...	0	1	6 39 03 110 ...	1	0	6 39 03 185 ...	1	0
6 35 02 172 ...	0	1	6 39 03 111 ...	2	2	6 39 03 186 ...	1	0
6 35 02 173 ...	0	1	6 39 03 113 ...	1	1	6 39 03 189 ...	1	1
6 35 02 177 ...	0	1	6 39 03 114 ...	1	1	6 39 03 190 ...	2	2
6 35 02 178 ...	0	1	6 39 03 115 ...	1	0	6 39 03 191 ...	1	1
6 35 02 179 ...	0	1	6 39 03 116 ...	2	2	6 39 03 194 ...	2	2
6 35 02 183 ...	1	2	6 39 03 117 ...	2	2	6 39 03 195 ...	2	2
6 35 02 185 ...	1	1	6 39 03 118 ...	1	0	6 39 03 196 ...	1	1
6 35 02 186 ...	0	0	6 39 03 120 ...	1	0	6 39 03 198 ...	2	2
6 35 02 189 ...	0	1	6 39 03 121 ...	1	0	6 39 03 206 ...	1	1
6 35 02 190 ...	0	1	6 39 03 122 ...	1	0	6 39 03 207 ...	1	1
6 35 02 192 ...	1	1	6 39 03 123 ...	2	2	6 39 03 208 ...	1	1
6 35 02 194 ...	1	1	6 39 03 124 ...	1	0	6 39 03 209 ...	1	1
6 35 02 195 ...	1	1	6 39 03 125 ...	2	2	6 39 03 210 ...	1	1
6 35 02 196 ...	0	1	6 39 03 127 ...	1	0	6 39 03 211 ...	1	1
6 35 02 209 ...	1	1	6 39 03 128 ...	1	1	6 39 03 212 ...	1	0
6 35 02 210 ...	1	1	6 39 03 129 ...	1	1	6 39 03 217 ...	1	1
6 35 02 211 ...	1	1	6 39 03 131 ...	1	1	6 39 03 221 ...	3	3
6 35 02 212 ...	1	1	6 39 03 132 ...	1	1	6 39 03 222 ...	3	3
6 35 02 234 ...	1	1	6 39 03 133 ...	1	1	6 39 03 223 ...	3	3
6 35 02 235 ...	1	1	6 39 03 143 ...	2	2	6 39 03 227 ...	1	1
6 37 06 018 ...	0	1	6 39 03 144 ...	1	1	6 39 03 228 ...	3	3
6 37 31 001 ...	0	0	6 39 03 146 ...	1	1	6 39 03 229 ...	2	2
6 37 31 002 ...	0	0	6 39 03 147 ...	1	0	6 39 03 230 ...	3	3
6 37 31 005 ...	0	1	6 39 03 152 ...	1	1	6 39 03 231 ...	2	2
6 38 06 129 ...	0	1	6 39 03 153 ...	1	1			
6 38 06 136 ...	0	1						



Imprint:

DE: C. & E. Fein GmbH (District Court Ulm, HRB 702155), Hans-Fein-Straße 81, 73529 Schwäbisch Gmünd-Bargau
Managing Director: Dr. Christoph Weiß

C. & E. Fein GmbH, Phone +49 7173 183-0, www.fein.com



Effective from 01/2022 Non-binding price recommendations. With this price list all previous price lists become invalid. The prices valid on the day of delivery are correct for invoice purposes. Subject to print errors and modifications concerning technique, shape and layout.

Printed in Germany. No responsibility is taken for the correctness of this information or illustrations. Subject to change and errors. Prices effective as at January 2022. 11.88.70.509.38.0.01.22 DEen